

# NCHRP

## SYNTHESIS 425

NATIONAL  
COOPERATIVE  
HIGHWAY  
RESEARCH  
PROGRAM

### Waterproofing Membranes for Concrete Bridge Decks



*A Synthesis of Highway Practice*

TRANSPORTATION RESEARCH BOARD  
OF THE NATIONAL ACADEMIES

## TRANSPORTATION RESEARCH BOARD 2011 EXECUTIVE COMMITTEE\*

### OFFICERS

**Chair:** *Neil J. Pedersen, Consultant, Silver Spring, MD*

**Vice Chair:** *Sandra Rosenbloom, Professor of Planning, University of Arizona, Tucson*

**Executive Director:** *Robert E. Skinner, Jr., Transportation Research Board*

### MEMBERS

J. BARRY BARKER, *Executive Director, Transit Authority of River City, Louisville, KY*

DEBORAH H. BUTLER, *Executive Vice President, Planning, and CIO, Norfolk Southern Corporation, Norfolk, VA*

WILLIAM A.V. CLARK, *Professor, Department of Geography, University of California, Los Angeles*

EUGENE A. CONTI, JR., *Secretary of Transportation, North Carolina DOT, Raleigh*

JAMES M. CRITES, *Executive Vice President of Operations, Dallas-Fort Worth International Airport, TX*

PAULA J. HAMMOND, *Secretary, Washington State DOT, Olympia*

MICHAEL W. HANCOCK, *Secretary, Kentucky Transportation Cabinet, Frankfort*

ADIB K. KANAFANI, *Cahill Professor of Civil Engineering, University of California, Berkeley*

MICHAEL P. LEWIS, *Director, Rhode Island DOT, Providence*

SUSAN MARTINOVICH, *Director, Nevada DOT, Carson City*

JOAN McDONALD, *Commissioner, New York State DOT, Albany*

MICHAEL R. MORRIS, *Director of Transportation, North Central Texas Council of Governments, Arlington*

TRACY L. ROSSER, *Vice President, Regional General Manager, Wal-Mart Stores, Inc., Mandeville, LA*

STEVEN T. SCALZO, *Chief Operating Officer, Marine Resources Group, Seattle, WA*

HENRY G. (GERRY) SCHWARTZ, JR., *Chairman (retired), Jacobs/Sverdrup Civil, Inc., St. Louis, MO*

BEVERLY A. SCOTT, *General Manager and CEO, Metropolitan Atlanta Rapid Transit Authority, Atlanta, GA*

DAVID SELTZER, *Principal, Mercator Advisors LLC, Philadelphia, PA*

LAWRENCE A. SELZER, *President and CEO, The Conservation Fund, Arlington, VA*

KUMARES C. SINHA, *Olson Distinguished Professor of Civil Engineering, Purdue University, West Lafayette, IN*

THOMAS K. SOREL, *Commissioner, Minnesota DOT, St. Paul*

DANIEL SPERLING, *Professor of Civil Engineering and Environmental Science and Policy; Director, Institute of Transportation Studies; and Interim Director, Energy Efficiency Center, University of California, Davis*

KIRK T. STEUDLE, *Director, Michigan DOT, Lansing*

DOUGLAS W. STOTLAR, *President and CEO, Con-Way, Inc., Ann Arbor, MI*

C. MICHAEL WALTON, *Ernest H. Cockrell Centennial Chair in Engineering, University of Texas, Austin*

### EX OFFICIO MEMBERS

J. RANDOLPH BABBITT, *Administrator, Federal Aviation Administration, U.S.DOT*

REBECCA M. BREWSTER, *President and COO, American Transportation Research Institute, Smyrna, GA*

ANNE S. FERRO, *Administrator, Federal Motor Carrier Safety Administration, U.S.DOT*

LEROY GISHI, *Chief, Division of Transportation, Bureau of Indian Affairs, U.S. Department of the Interior, Washington, DC*

JOHN T. GRAY, *Senior Vice President, Policy and Economics, Association of American Railroads, Washington, DC*

JOHN C. HORSLEY, *Executive Director, American Association of State Highway and Transportation Officials, Washington, DC*

DAVID T. MATSUDA, *Deputy Administrator, Maritime Administration, U.S.DOT*

MICHAEL P. MELANIPHY, *President, American Public Transportation Association, Washington, DC*

VICTOR M. MENDEZ, *Administrator, Federal Highway Administration, U.S.DOT*

TARA O'TOOLE, *Under Secretary for Science and Technology, U.S. Department of Homeland Security, Washington, DC*

ROBERT J. PAPP (Adm., U.S. Coast Guard), *Commandant, U.S. Coast Guard, U.S. Department of Homeland Security, Washington, DC*

CYNTHIA L. QUARTERMAN, *Administrator, Pipeline and Hazardous Materials Safety Administration, U.S.DOT*

PETER M. ROGOFF, *Administrator, Federal Transit Administration, U.S.DOT*

DAVID L. STRICKLAND, *Administrator, National Highway Traffic Safety Administration, U.S.DOT*

JOSEPH C. SZABO, *Administrator, Federal Railroad Administration, U.S.DOT*

POLLY TROTTENBERG, *Assistant Secretary for Transportation Policy, U.S.DOT*

ROBERT L. VAN ANTWERP (Lt. Gen., U.S. Army), *Chief of Engineers and Commanding General, U.S. Army Corps of Engineers, Washington, DC*

BARRY R. WALLERSTEIN, *Executive Officer, South Coast Air Quality Management District, Diamond Bar, CA*

GREGORY D. WINFREE, *Acting Administrator, Research and Innovative Technology Administration, U.S.DOT*

---

\*Membership as of November 2011.

---

---

**NCHRP SYNTHESIS 425**

---

---

**Waterproofing Membranes for  
Concrete Bridge Decks**

***A Synthesis of Highway Practice***

**CONSULTANT**  
HENRY G. RUSSELL  
Henry G. Russell, Inc.  
Glenview, Illinois

**SUBSCRIBER CATEGORIES**  
Bridges and Other Structures • Highways • Maintenance and Preservation

---

Research Sponsored by the American Association of State Highway and Transportation Officials  
in Cooperation with the Federal Highway Administration

---

**TRANSPORTATION RESEARCH BOARD**

WASHINGTON, D.C.  
2012  
[www.TRB.org](http://www.TRB.org)

## NATIONAL COOPERATIVE HIGHWAY RESEARCH PROGRAM

Systematic, well-designed research provides the most effective approach to the solution of many problems facing highway administrators and engineers. Often, highway problems are of local interest and can best be studied by highway departments individually or in cooperation with their state universities and others. However, the accelerating growth of highway transportation develops increasingly complex problems of wide interest to highway authorities. These problems are best studied through a coordinated program of cooperative research.

In recognition of these needs, the highway administrators of the American Association of State Highway and Transportation Officials initiated in 1962 an objective national highway research program employing modern scientific techniques. This program is supported on a continuing basis by funds from participating member states of the Association and it receives the full cooperation and support of the Federal Highway Administration, United States Department of Transportation.

The Transportation Research Board of the National Research Council was requested by the Association to administer the research program because of the Board's recognized objectivity and understanding of modern research practices. The Board is uniquely suited for this purpose as it maintains an extensive committee structure from which authorities on any highway transportation subject may be drawn; it possesses avenues of communication and cooperation with federal, state, and local governmental agencies, universities, and industry; its relationship to the National Research Council is an insurance of objectivity; it maintains a full-time research correlation staff of specialists in highway transportation matters to bring the findings of research directly to those who are in a position to use them.

The program is developed on the basis of research needs identified by chief administrators of the highway and transportation departments and by committees of AASHTO. Each year, specific areas of research needs to be included in the program are proposed to the National Research Council and the Board by the American Association of State Highway and Transportation Officials. Research projects to fulfill these needs are defined by the Board, and qualified research agencies are selected from those that have submitted proposals. Administration and surveillance of research contracts are the responsibilities of the National Research Council and the Transportation Research Board.

The needs for highway research are many, and the National Cooperative Highway Research Program can make significant contributions to the solution of highway transportation problems of mutual concern to many responsible groups. The program, however, is intended to complement rather than to substitute for or duplicate other highway research programs.

---

**NOTE:** The Transportation Research Board of the National Academies, the National Research Council, the Federal Highway Administration, the American Association of State Highway and Transportation Officials, and the individual states participating in the National Cooperative Highway Research Program do not endorse products or manufacturers. Trade or manufacturers' names appear herein solely because they are considered essential to the object of this report.

## NCHRP SYNTHESIS 425

Project 20-05 (Topic 42-07)

ISSN 0547-5570

ISBN 978-0-309-22346-1

Library of Congress Control No. 2011943710

© 2012 National Academy of Sciences. All rights reserved.

## COPYRIGHT INFORMATION

Authors herein are responsible for the authenticity of their manuscripts and for obtaining written permissions from publishers or persons who own the copyright to any previously published or copyrighted material used herein.

Cooperative Research Programs (CRP) grants permission to reproduce material in this publication for classroom and not-for-profit purposes. Permission is given with the understanding that none of the material will be used to imply TRB, AASHTO, FAA, FHWA, FMSCA, FTA, or Transit development Corporation endorsement of a particular product, method, or practice. It is expected that those reproducing the material in this document for educational and not-for-profit uses will give appropriate acknowledgment of the source of any development or reproduced material. For other uses of the material, request permission from CRP.

## NOTICE

The project that is the subject of this report was a part of the National Co-operative Highway Research Program conducted by the Transportation Research Board with the approval of the Governing Board of the National Research Council. Such approval reflects the Governing Board's judgment that the program concerned is of national importance and appropriate with respect to both the purposes and resources of the National Research Council.

The members of the technical committee selected to monitor this project and to review this report were chosen for recognized scholarly competence and with due consideration for the balance of disciplines appropriate to the project. The opinions and conclusions expressed or implied are those of the research agency that performed the research, and, while they have been accepted as appropriate by the technical committee, they are not necessarily those of the Transportation Research Board, the National Research Council, the American Association of State Highway and Transportation Officials, or the Federal Highway Administration of the U.S. Department of Transportation.

Each report is reviewed and accepted for publication by the technical committee according to procedures established and monitored by the Transportation Research Board Executive Committee and the Governing Board of the National Research Council.

*Published reports of the*

## NATIONAL COOPERATIVE HIGHWAY RESEARCH PROGRAM

*are available from:*

Transportation Research Board  
Business Office  
500 Fifth Street, NW  
Washington, DC 20001

*and can be ordered through the Internet at:*

<http://www.national-academies.org/trb/bookstore>

Printed in the United States of America

# THE NATIONAL ACADEMIES

## *Advisers to the Nation on Science, Engineering, and Medicine*

The **National Academy of Sciences** is a private, nonprofit, self-perpetuating society of distinguished scholars engaged in scientific and engineering research, dedicated to the furtherance of science and technology and to their use for the general welfare. On the authority of the charter granted to it by the Congress in 1863, the Academy has a mandate that requires it to advise the federal government on scientific and technical matters. Dr. Ralph J. Cicerone is president of the National Academy of Sciences.

The **National Academy of Engineering** was established in 1964, under the charter of the National Academy of Sciences, as a parallel organization of outstanding engineers. It is autonomous in its administration and in the selection of its members, sharing with the National Academy of Sciences the responsibility for advising the federal government. The National Academy of Engineering also sponsors engineering programs aimed at meeting national needs, encourages education and research, and recognizes the superior achievements of engineers. Dr. Charles M. Vest is president of the National Academy of Engineering.

The **Institute of Medicine** was established in 1970 by the National Academy of Sciences to secure the services of eminent members of appropriate professions in the examination of policy matters pertaining to the health of the public. The Institute acts under the responsibility given to the National Academy of Sciences by its congressional charter to be an adviser to the federal government and, on its own initiative, to identify issues of medical care, research, and education. Dr. Harvey V. Fineberg is president of the Institute of Medicine.

The **National Research Council** was organized by the National Academy of Sciences in 1916 to associate the broad community of science and technology with the Academy's purposes of furthering knowledge and advising the federal government. Functioning in accordance with general policies determined by the Academy, the Council has become the principal operating agency of both the National Academy of Sciences and the National Academy of Engineering in providing services to the government, the public, and the scientific and engineering communities. The Council is administered jointly by both Academies and the Institute of Medicine. Dr. Ralph J. Cicerone and Dr. Charles M. Vest are chair and vice chair, respectively, of the National Research Council.

The **Transportation Research Board** is one of six major divisions of the National Research Council. The mission of the Transportation Research Board is to provide leadership in transportation innovation and progress through research and information exchange, conducted within a setting that is objective, interdisciplinary, and multimodal. The Board's varied activities annually engage about 7,000 engineers, scientists, and other transportation researchers and practitioners from the public and private sectors and academia, all of whom contribute their expertise in the public interest. The program is supported by state transportation departments, federal agencies including the component administrations of the U.S. Department of Transportation, and other organizations and individuals interested in the development of transportation. [www.TRB.org](http://www.TRB.org)

[www.national-academies.org](http://www.national-academies.org)

## **NCHRP COMMITTEE FOR PROJECT 20-05**

### **CHAIR**

CATHERINE NELSON  
*Oregon DOT*

### **MEMBERS**

KATHLEEN S. AMES

*Michael Baker, Jr., Inc.*

STUART D. ANDERSON

*Texas A&M University*

BRIAN A. BLANCHARD

*Florida DOT*

CYNTHIA J. BURBANK

*PB Americas, Inc.*

LISA FREESE

*Scott County (MN) Public Works Division*

MALCOLM T. KERLEY

*Virginia DOT*

RICHARD D. LAND

*California DOT*

JOHN M. MASON, JR.

*Auburn University*

ROGER C. OLSON

*Minnesota DOT*

ROBERT L. SACK

*New York State DOT*

FRANCINE SHAW-WHITSON

*Federal Highway Administration*

LARRY VELASQUEZ

*JAVEL Engineering, LLC*

### **FHWA LIAISONS**

JACK JERNIGAN

MARY LYNN TISCHER

### **TRB LIAISON**

STEPHEN F. MAHER

## **COOPERATIVE RESEARCH PROGRAMS STAFF**

CHRISTOPHER W. JENKS, *Director, Cooperative  
Research Programs*

CRAWFORD F. JENCKS, *Deputy Director, Cooperative  
Research Programs*

NANDA SRINIVASAN, *Senior Program Officer*

EILEEN P. DELANEY, *Director of Publications*

## **SYNTHESIS STUDIES STAFF**

STEPHEN R. GODWIN, *Director for Studies and  
Special Programs*

JON M. WILLIAMS, *Program Director, IDEA and  
Synthesis Studies*

JO ALLEN GAUSE, *Senior Program Officer*

GAIL R. STABA, *Senior Program Officer*

DONNA L. VLASAK, *Senior Program Officer*

TANYA M. ZWAHLEN, *Consultant*

DON TIPPMAN, *Senior Editor*

CHERYL KEITH, *Senior Program Assistant*

DEMISHA WILLIAMS, *Senior Program Assistant*

DEBBIE IRVIN, *Program Associate*

## **TOPIC PANEL**

JUGESH KAPUR, *Washington State Department of  
Transportation*

EROL C. KASLAN, *California Department of Transportation*

ROBERT KOGLER, *Rampart, LLC, Falls Church, VA*

STEPHEN F. MAHER, *Transportation Research Board*

MICHAEL M. SPRINKEL, *Virginia Department of  
Transportation*

TIMOTHY STALLARD, *Michigan Department of  
Transportation*

PETER J. WEYKAMP, *New York State Department of  
Transportation*

REGGIE H. HOLT, *Federal Highway Administration (Liaison)*

PAUL VIRMANI, *Federal Highway Administration (Liaison)*

**Cover Figure:** Installation of preformed sheet waterproofing membrane on a concrete bridge deck (*Courtesy: New York State DOT*).

## FOREWORD

Highway administrators, engineers, and researchers often face problems for which information already exists, either in documented form or as undocumented experience and practice. This information may be fragmented, scattered, and unevaluated. As a consequence, full knowledge of what has been learned about a problem may not be brought to bear on its solution. Costly research findings may go unused, valuable experience may be overlooked, and due consideration may not be given to recommended practices for solving or alleviating the problem.

There is information on nearly every subject of concern to highway administrators and engineers. Much of it derives from research or from the work of practitioners faced with problems in their day-to-day work. To provide a systematic means for assembling and evaluating such useful information and to make it available to the entire highway community, the American Association of State Highway and Transportation Officials—through the mechanism of the National Cooperative Highway Research Program—authorized the Transportation Research Board to undertake a continuing study. This study, NCHRP Project 20-05, “Synthesis of Information Related to Highway Problems,” searches out and synthesizes useful knowledge from all available sources and prepares concise, documented reports on specific topics. Reports from this endeavor constitute an NCHRP report series, *Synthesis of Highway Practice*.

This synthesis series reports on current knowledge and practice, in a compact format, without the detailed directions usually found in handbooks or design manuals. Each report in the series provides a compendium of the best knowledge available on those measures found to be the most successful in resolving specific problems.

## PREFACE

*By Jo Allen Gause  
Senior Program Officer  
Transportation  
Research Board*

The objective of this synthesis study was to update *NCHRP Synthesis of Highway Practice 220: Waterproofing Membranes for Concrete Bridge Decks*, a report on the same topic published in 1995. This synthesis documents information on materials, specification requirements, design details, application methods, system performance, and costs of waterproofing membranes used on new and existing bridge decks since 1995. The synthesis focuses on North American practices with some information provided about systems used in Europe and Asia.

Information used in this study was acquired through a review of the literature and surveys of state departments of transportation and Canadian provincial transportation agencies. For additional details, follow-up interviews were conducted with several agencies.

Henry G. Russell, Henry G. Russell, Inc., Glenview, Illinois, collected and synthesized the information and wrote the report. The members of the topic panel are acknowledged on the preceding page. This synthesis is an immediately useful document that records the practices that were acceptable within the limitations of the knowledge available at the time of its preparation. As progress in research and practice continues, new knowledge will be added to that now at hand.





# CONTENTS

1	SUMMARY
3	CHAPTER ONE INTRODUCTION <ul style="list-style-type: none"><li>Background and History, 3</li><li>Membrane Systems, 4</li><li>Recent Usage, 4</li><li>Scope, 6</li></ul>
7	CHAPTER TWO WATERPROOFING MEMBRANE SYSTEMS <ul style="list-style-type: none"><li>Materials, 7</li><li>Specifications and Standards, 8</li><li>Selection Criteria, 12</li><li>Design Details, 12</li><li>Construction and Inspection, 17</li><li>Performance, 20</li><li>Costs, 22</li><li>Repairs, 23</li></ul>
24	CHAPTER THREE TESTING AND RESEARCH <ul style="list-style-type: none"><li>Laboratory Testing, 24</li><li>Evaluating Field Installations, 24</li><li>Recent Research, 26</li></ul>
27	CHAPTER FOUR CONCLUSIONS AND RESEARCH NEEDS <ul style="list-style-type: none"><li>Conclusions, 27</li><li>Future Research, 28</li></ul>
30	REFERENCES
33	APPENDIX A SURVEY QUESTIONNAIRE
40	APPENDIX B SUMMARY OF RESPONSES TO SURVEY QUESTIONNAIRE



# WATERPROOFING MEMBRANES FOR CONCRETE BRIDGE DECKS

**SUMMARY** Concrete bridge deck deterioration is one of the most extensive bridge maintenance problems affecting the service life of bridges. One cause of the deterioration is the penetration of moisture and chlorides into the concrete with subsequent corrosion of the steel reinforcement. The use of waterproofing membranes is one strategy to prevent moisture and chlorides from reaching the concrete by providing a barrier on the top of the concrete deck. The waterproofing membrane is then protected from the traffic by an asphalt overlay.

The objective of this synthesis is to update *NCHRP Synthesis of Highway Practice 220: Waterproofing Membranes for Concrete Bridge Decks* on the same topic published in 1995. This synthesis documents information on materials, specification requirements, design details, application methods, system performance, and costs of waterproofing membranes used on new and existing bridge decks since 1995. The synthesis focuses on North American practices with some information provided about systems used in Europe and Asia.

Information for the synthesis was gathered from a survey sent to all U.S. state departments of transportation (DOTs) and all Canadian provincial transportation agencies. The DOT survey achieved an 84% response rate (42 responses); the Canadian survey response rate was 83% (10 responses). Several agencies were contacted after the survey for additional details. Information was also obtained from U.S. national specifications, state and provincial specifications, a literature review, and manufacturers' literature. Key findings are described in the following paragraphs.

Based on information collected for this synthesis, waterproofing membrane systems generally consist of either preformed sheet systems or liquid systems. Preformed sheet systems are often rolled into place and bonded to the concrete deck using a pressure-sensitive adhesive on the sheet or through the use of heat to bond the membrane to the concrete deck. Liquid systems are applied as either hot or cold liquids and may include a layer of reinforcing fabric. All waterproofing systems use proprietary products; the agencies identified at least 23 different proprietary products used in the last 16 years. After installation, the membrane is covered with a layer of asphalt to protect the membrane and provide a riding surface. Primers are applied to the concrete deck to increase the bond between the concrete and the waterproofing membrane. A tack coat is used between the membrane and the asphalt overlay to increase the bond between these two materials. This report includes a list of practices that are used for the installation of waterproofing membranes (see chapter two).

The survey and literature review found that most Canadian provinces and many European countries require the use of waterproofing membranes on all new bridge decks. In contrast, only 60% of U.S. state agencies reported the use of waterproofing membranes. More states reported using them on existing bridge decks to prolong the service life rather than installing them on new bridge decks at the time of construction. The reasons agencies do not use waterproofing membranes include nonuse of deicing salts, poor performance of membranes in the past, the use of alternative deck protection strategies, and the preference for having an exposed concrete deck to observe any deterioration. However, many agencies

that do use them believe they provide a reliable protection strategy. The types of membranes used and the states that use them have not changed much since the 1994 survey.

The survey identified that agencies have a broad range of criteria for when membranes are used, ranging from standard practices to temporary fixes. Waterproofing membrane types are selected for a variety of reasons, with the primary reasons being track record of previous installations, cost, and desired service life. Yet approximately 50% of the agencies that use waterproofing membranes do not have standard details relating to their installation. In many cases, the installation is required to conform to the manufacturer's procedures.

Agencies that used waterproofing membranes expect them to last 16 to 20 years when installed on new bridge decks and 6 to 20 years when installed on existing bridge decks. This expectation is often dictated by the service life of the asphalt wearing surface, which includes one resurfacing of the asphalt.

Information obtained from the survey and additional contact with several agencies that have used multiple systems revealed little unbiased literature and data about the performance of different systems. Although there are reports about products failing to work properly on individual bridges, there does not appear to be a general consensus across North America about the best materials to use. The Canadian provinces, however, appear to have a preference for using rubberized asphalt membranes.

The survey respondents identified several types of defects observed with waterproofing membranes. The predominant ones are a lack of adhesion between the membrane and the concrete deck, lack of adhesion between the membrane and the asphalt surface, and moisture penetrating through the membrane. All types of defects were more prominent with membranes applied to existing bridge decks than with membranes applied to new bridge decks. Most manufacturers recommend a primer on the concrete deck and a tack coat on the waterproofing membrane to improve the adhesion between the layers.

The literature review identified only a limited number of articles about the use of waterproofing membranes published since *NCHRP Synthesis 220* in 1995. Consequently, this synthesis relies heavily on analyses of information obtained from the survey and state and provincial specifications. The literature review and survey also identified that limited research on waterproofing membranes has been performed since 1995.

This synthesis identified gaps in the knowledge base that could be filled with the following research:

- Conduct a more in-depth investigation of existing systems used in the United States and Canada, including site visits and meetings with owners who have installed membranes successfully and believe in their use as a deck protection strategy.
- Develop standard test methods to evaluate the overall performance of waterproofing membrane systems, to assess the quality of the installed system, and to determine whether the membrane is deteriorating during its service life.

## CHAPTER ONE

## INTRODUCTION

## BACKGROUND AND HISTORY

Concrete bridge deck deterioration is one of the most extensive maintenance problems affecting the service life of bridges. Moisture and chloride intrusion can accelerate concrete bridge deck distress through corrosion of the steel reinforcement. A 2009 International Scan, *Assuring Bridge Safety and Serviceability in Europe (1)*, found that European agencies consistently reported success incorporating waterproofing membranes into concrete bridge deck construction to both extend service life and delay the need to rehabilitate or replace bridge decks. In contrast, their general use in the United States remains limited.

The first NCHRP synthesis report on bridge deck durability, *NCHRP Synthesis of Highway Practice 4: Concrete Bridge Durability (2)*, reported that bridge deck deterioration was a major maintenance item, with the most commonly reported conditions being cracking, scaling, and spalling. Spalling was considered to be the most serious defect, with the cause attributed to corrosion of the reinforcing steel. The same report stated that the use of an impermeable interlayer membrane had won favor throughout the country, with Maine, Massachusetts, New Hampshire, and Rhode Island specifying it for all important bridges. California, Illinois, Michigan, Ohio, and Tennessee were specifying membranes on selected bridges.

In 1976, the FHWA published a policy requiring all federal-aid system structures that might be damaged by deicing salts to apply a deck protective system (3). One option was to use a waterproofing membrane. The market for waterproofing systems expanded as new products were introduced and put to use.

A second NCHRP synthesis dealing with durability of concrete bridges, *NCHRP Synthesis of Highway Practice 57: Durability of Concrete Bridge Decks (4)*, reported that concrete bridge deck durability continued to be a problem because of corrosion of steel reinforcement. Membranes were reported to be available in a variety of systems; however, field experience had been highly variable, leading to doubt about their long-term performance. In a 1977 survey, only 19% of the respondents indicated that membranes were the preferred protective system on new decks,

and only 11% selected membranes as one of the first three options for deck repair (5).

*NCHRP Report 297: Evaluation of Bridge Deck Protective Strategies (6)* reported the results of an investigation of five strategies for preventing corrosion in bridge decks. Waterproofing membranes with asphalt overlays were found to be effective in preventing salt intrusion into the underlying deck. Nevertheless, after 10 to 15 years of service, membranes had deteriorated as a result of aging and traffic. The report concluded that such membranes, when properly constructed, can prevent salt infiltration indefinitely, but their service life depended on the rate at which the membrane deteriorated.

Babaie and Hawkins (6) explained that the accumulation of water above the membrane in the bottom portion of the asphaltic concrete was the primary cause of deterioration. This phenomenon, combined with freezing and thawing and repeated hydraulic pressure from traffic, weakens both the bottom layer of the asphalt and the bond between the asphaltic concrete and the membrane.

*NCHRP Synthesis of Highway Practice 220: Waterproofing Membranes for Concrete Bridge Decks (5)* stated that 25% of state highway agencies reported using membranes on new bridge decks. The synthesis also reported that agencies are sharply divided on the merits of waterproofing bridge decks. Reasons given for not using membranes included the inability to inspect the top surface of the deck, poor performance of experimental installations, and short service life of asphalt overlays. Other agencies reported that membranes were cost-effective in new construction, and especially so in rehabilitation.

In a survey for *NCHRP Synthesis 333: Concrete Bridge Deck Performance (7)*, respondents were asked to identify which waterproofing membrane systems they had used in the past and which they were using in 2004. The information identified that the only major change in the use of membranes had been a reduction in the number of agencies using preformed systems with asphalt-impregnated fabric, asphalt-laminated board, and polymers. The number of agencies using elastomer preformed systems and liquid systems remained about the same. In a rating of 1 to 5 for



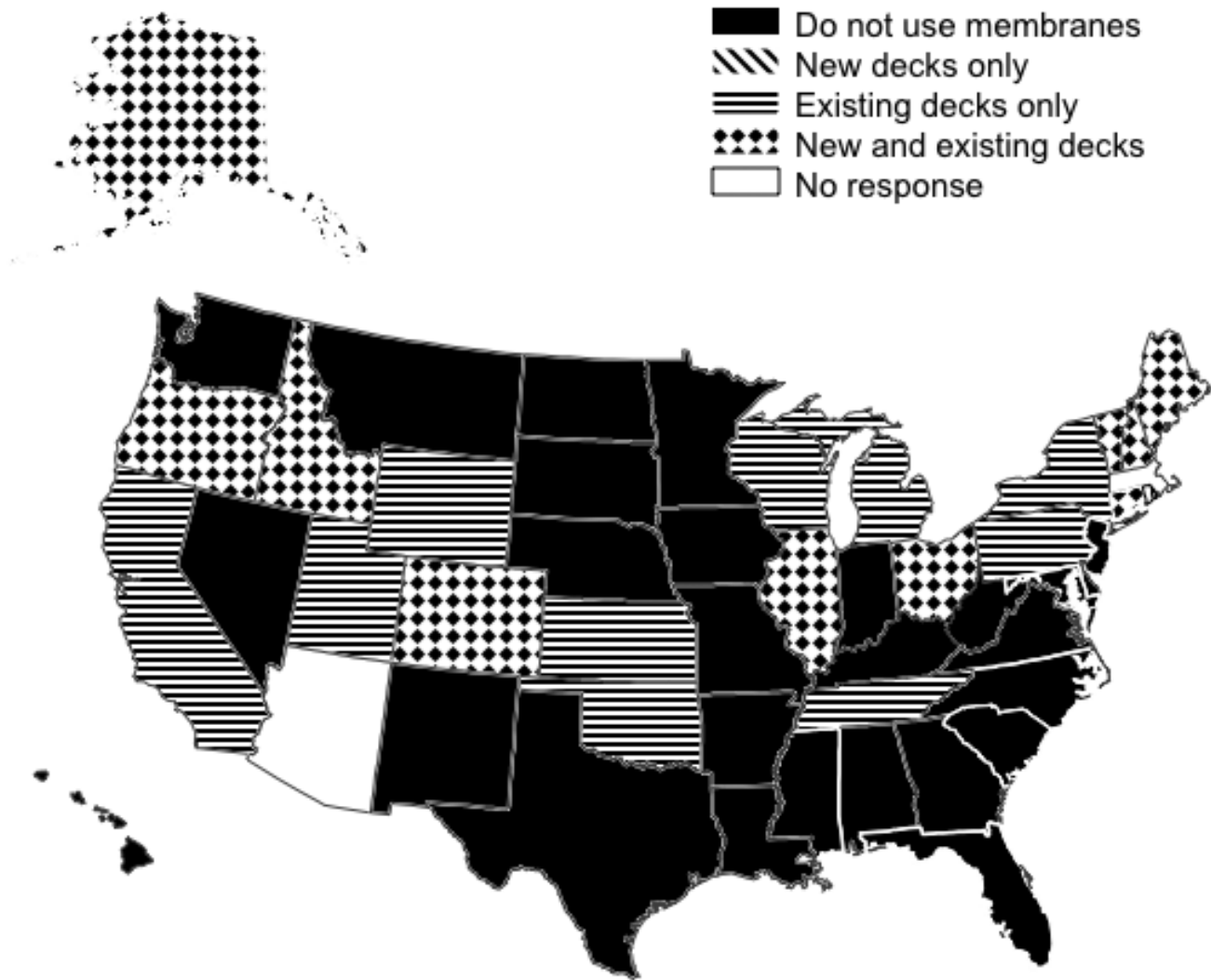

FIGURE 2 Usage of waterproofing membranes in the United States, 1992 [Source: Adapted from Manning 1995 (5)].

The three states that have discontinued the use of waterproofing membranes provided various reasons. New Jersey indicated that it has discontinued the use of waterproofing membranes in favor of an impervious bridge deck waterproofing surface course. The specification does not permit the use of dynamic rollers to compact the hot mix asphalt overlay on bridge decks, which has created some issues about the porosity of the overlay. The use of a bridge deck waterproofing surface course avoids the issue because it can be compacted using a static roller.

New Mexico reported that membranes have not worked well, resulting in water and salt being trapped between the asphalt and the deck. With subsequent freeze-thaw cycles, the asphalt spalls off and the deck deteriorates. When used on adjacent box beam bridges, the membranes cracked at the interface between the box beams, allowing water and salt to penetrate. New Mexico now prefers to use a concrete deck with reinforcement on these types of structures.

Texas reported that it does not recommend placing asphalt on bridge decks and does not use proprietary waterproofing systems. Its waterproofing system consists of an asphalt oil followed by the application of two courses of rock.

In Canada, New Brunswick reported that it discontinued the use of two self-adhesive preformed systems after concerns were raised about a number of debonding failures. Quebec reported that it discontinued the use of certain spray-applied liquid systems because of the difficulty of maintaining the required thickness. Both provinces continue to use other types of membranes.

*NCHRP Synthesis 220* contained a table showing the results of four surveys between 1974 and 1994 about the use of waterproofing membranes on new or existing bridge decks. Table 1 reproduces a portion of this table, along with data obtained from the synthesis survey. In 1994, it was concluded that the use of waterproofing membranes had declined

TABLE 1  
STATE AGENCY RESPONSE TO VARIOUS SURVEYS ON THE USE OF MEMBRANES

	New Construction					Existing Bridge Decks			
	1974 <sup>1</sup>	1977 <sup>1</sup>	1986 <sup>1</sup>	1994 <sup>1</sup>	2011 <sup>2</sup>	1977 <sup>1</sup>	1989 <sup>1</sup>	1994 <sup>1</sup>	2011 <sup>2</sup>
Membrane use %	74	69	53	25	26	58	51	46	47
No. of Responses	42	48	45	48	43	48	47	48	43

<sup>1</sup> From *NCHRP Synthesis 220* (Manning 1995).

<sup>2</sup> From survey for this synthesis.

in the previous 20 years. It now appears that the decline has bottomed out for both new and existing bridge decks, as the percentages for 2011 and 1994 are almost identical. It is also evident that more states continue to use waterproofing membranes on existing bridge decks than new bridge decks.

One observation from the survey is that waterproofing membranes are used proportionately more in Canada than in the United States. Nine of 10 respondents from Canada reported their use on either new or existing bridge decks, compared with 25 of 43 respondents (58%) in the United States. A similar observation was made in *NCHRP Synthesis 220*.

Agencies that do not use or have discontinued their use of waterproofing membranes provided numerous reasons for their decision, including the following:

- Do not use deicing salts on bridge decks or experience only a few freeze-thaw cycles and, therefore, see no benefit to using a waterproofing membrane.
- Have experienced poor performance of waterproofing membranes in the past.
- Have adopted the use of alternative deck protection strategies such as concrete overlays or full-depth low permeability concrete.
- Prefer to have an exposed concrete deck for easy visual inspection of any deterioration. With a waterproofing membrane, the concrete deck surface cannot be inspected.

Some agencies responded that they limit the use of waterproofing membranes to certain types of superstructures such as voided slabs or deck bulb-tees or only use waterproofing membranes to extend the life of an existing bridge for a few years.

## SCOPE

For the purpose of this synthesis, a waterproofing membrane is defined as a thin impermeable layer that is used in conjunction with a hot mix asphalt wearing surface. This study updates *NCHRP Synthesis 220: Waterproofing*

*Membranes for Concrete Bridge Decks* (5). Consequently, it mainly includes information that has been published since 1994. The synthesis documents information related to materials, specification requirements, design details, application methods, construction inspection, system performance, and costs of waterproofing membranes for both new and existing bridge decks. In particular, it identifies domestically available materials, processes, specifications, and installation practices that have been reported. It is intended to help practitioners and bridge owners determine the appropriate use of membranes as an alternative to other bridge deck protection strategies.

The information in the synthesis was gathered from literature reviews and surveys of highway agencies in the United States through the AASHTO Highway Subcommittee on Bridges and Structures and in the Canadian provinces through the Transportation Association of Canada. Some information about European and Asian systems and practices is included.

The remaining text of this synthesis is organized as follows.

Chapter two identifies and discusses items related to the use of waterproofing membrane systems with new construction and existing bridge decks. These include materials used in membrane systems, materials and construction specifications, design issues, construction and inspection details and practices, observed performance, and costs.

Chapter three describes laboratory testing methods, field evaluation methods, and recent research.

Chapter four summarizes the findings from the information collected for this synthesis. It includes a list of the practices that are used with waterproofing membrane systems for concrete bridge decks. Important knowledge gaps that are worthy of research are identified.

Appendix A provides the survey questionnaire, and Appendix B summarizes the responses to the questionnaire.



## CHAPTER TWO

**WATERPROOFING MEMBRANE SYSTEMS****MATERIALS**

As part of the survey for this synthesis, respondents were asked to identify what waterproofing products they had used since 1994. At least 23 different proprietary products from 19 companies have been used as waterproofing membrane systems on bridge decks in the United States and Canada since 1994. In the 1992 survey for *NCHRP Synthesis 220*, 22 different proprietary products were identified (5). In general, the systems can be classified as either preformed sheet systems or liquid systems, with approximately an equal number of products of each type.

As depicted in Figure 3, preformed sheet systems involve the application of a primer to the clean concrete deck to improve the adhesion of the membrane to the deck. This is followed by installation of the membrane. Most preformed systems identified in the survey included a self-adhesive backing on the membrane sheet. These sheets can be rolled into place and then bonded to the deck primer using a roller. In other systems, the membrane is bonded to the deck by heating the membrane using either a hand torch or a machine. After the membrane is installed, a tack coat is applied to the top surface to increase bond with the asphalt overlay.

Materials used to form the sheet membranes are described by the various manufacturers as rubberized asphalt, bituminous membrane, polymer-modified asphalt, modified bitumen, polymeric membrane, or bitumen and polymers.

As depicted in Figure 4, liquid systems generally consist of application of a primer followed by application of the membrane. The membrane may be placed using either spray equipment or rollers and squeegees. The membranes are applied either hot or cold depending on the manufacturer's requirements. Liquid systems may or may not contain a reinforcing fabric.

If a reinforcing fabric is used, one layer of liquid is sprayed. The fabric is then placed on the liquid and a second layer of liquid placed on top. A tack coat is generally used with liquid systems before placement of the asphalt overlay. Various manufacturers describe the materials used for the liquid systems as rubberized asphalt, two-component polymer, polyurethane, methyl methacrylate, rubber polymer, polymer-modified asphalt, or rubberized bitumen.

Twelve states reported information on the products they have used. Six states have used only preformed systems, two have used only liquid systems, and four have used both systems. In Canada, two provinces reported using only preformed systems, two used only liquid systems, and three used both systems.

According to Kepler et al. (8), three types of waterproofing membranes were used in North America in 2000: preformed sheets, liquid membranes, and built-up systems. Preformed sheets were most often used in the United States, while a liquid membrane of hot applied rubberized asphalt was used exclusively in Canada. It was also the most common liquid membrane used in North America.

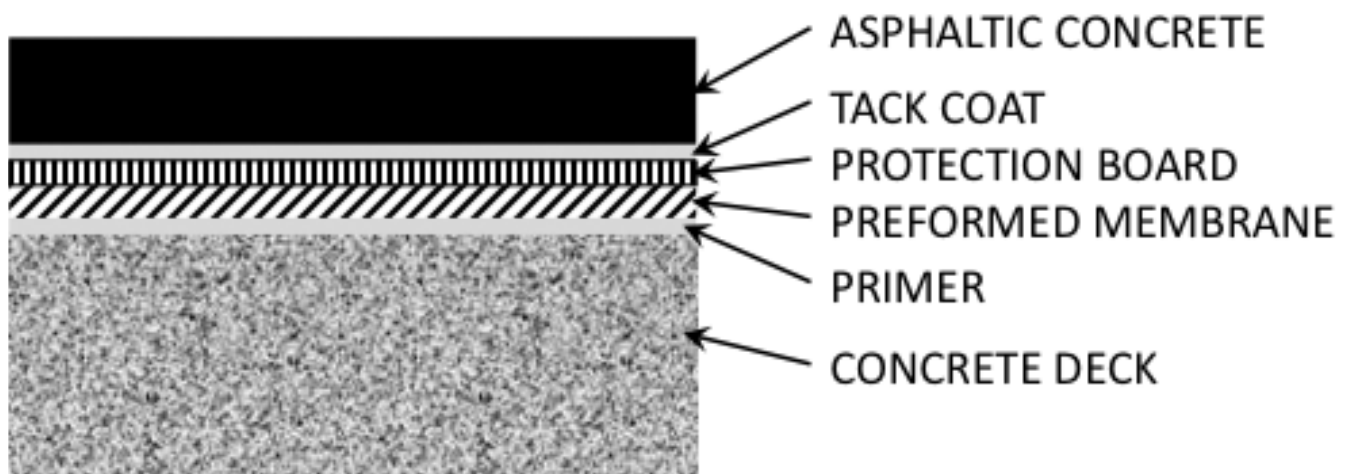

FIGURE 3 Schematic of possible components of preformed systems.

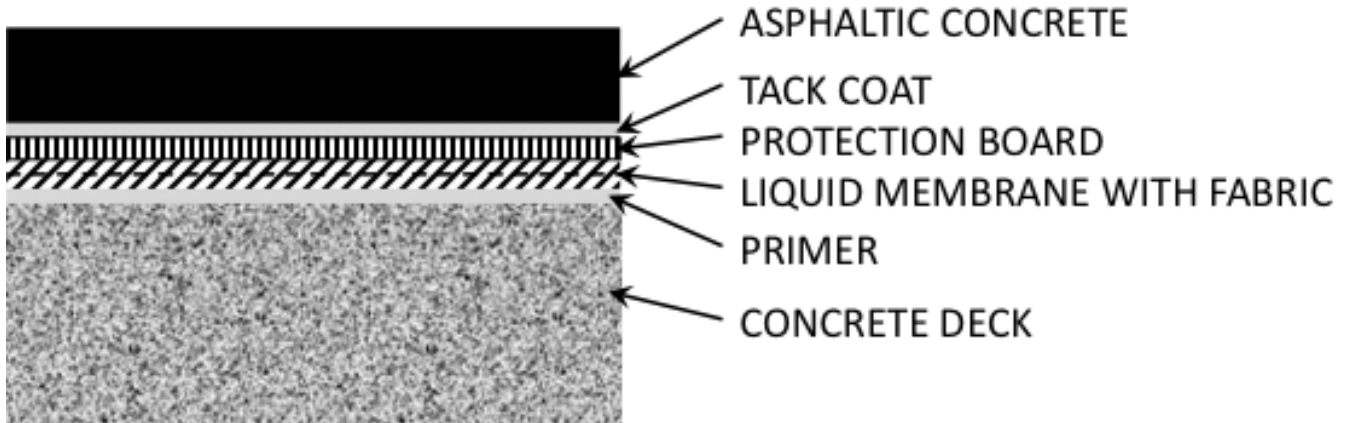

FIGURE 4 Schematic of possible components of liquid systems.

## SPECIFICATIONS AND STANDARDS

### AASHTO Specifications

Waterproofing of concrete bridge decks is addressed as part of Section 21 of the AASHTO *LRFD Bridge Construction Specifications* (9). Waterproofing is defined as either a constructed-in-place asphalt membrane system or a preformed membrane system, both of which include appropriate priming materials and, when required, protective coverings.

An asphalt membrane system consists of a coat of primer applied to the prepared surface, a firmly bonded membrane composed of two layers of saturated fabric, and three moppings of waterproofing asphalt with a protective cover when required. Materials listed for use with asphalt membrane systems are required to conform to one or more of the following ASTM specifications published by ASTM International, West Conshohocken, Pennsylvania:

- D41 Standard Specification for Asphalt Primer Used in Roofing, Dampproofing, and Waterproofing (used for the primer)
- D173 Standard Specification for Bitumen-Saturated Cotton Fabrics Used in Roofing Waterproofing (used for the reinforcing fabric)
- D449 Standard Specification for Asphalt Used in Dampproofing and Waterproofing (used for the asphalt)
- D3515 Standard Specifications for Woven Glass Fabric Treated with Asphalt (used for the reinforcing fabric).

According to the AASHTO specifications, a preformed membrane system consists of a primer applied to the prepared surface, a single layer of adhering preformed membrane sheet, and a protective cover when required. Preformed membrane sheets consist of either the rubberized asphalt system or the modified bitumen type. Both types are required by the specifications to conform to minimum values for the following properties:

- Tensile strength in machine direction per ASTM D882 Method A of 50 lb/in. for rubberized asphalt and 40 lb/in. for modified bitumen.
- Percentage elongation at breach in machine direction per ASTM D882 Method A of 15% for rubberized asphalt and 10% for bitumen at 73.4°F.
- Pliability per ASTM D146 based on 180-degree bend over a 4-in. diameter mandrel at 10°F with no cracks.
- Minimum thickness of 65 mils for rubberized asphalt and 70 mils for modified bitumen.
- Softening point per ASTM D36 of 165°F for rubberized asphalt bitumen and 210°F for modified bitumen.

All materials are required to be tested before shipment.

For roadway surfaces of bridge decks, the protective cover to the waterproofing system is required to consist of a layer of special asphalt concrete as specified in the contract documents.

The AASHTO specifications require that all concrete surfaces to be waterproofed shall be reasonably smooth and free of foreign matter, projections, or holes. The surface shall be dry and have a temperature not less than 35°F or that recommended by the manufacturer, unless otherwise approved by the engineer. The specifications contain specific detailed instructions for the installation of asphalt membrane waterproofing systems and preformed membrane waterproofing systems.

### State Specifications

State specifications for waterproofing membranes are similar to the AASHTO specifications. Table 2 reviews the differences identified in the state specifications.

Some states specify more details than the AASHTO specifications; others specify fewer. Some of the states with fewer details rely heavily on the manufacturer's recommended installation procedures and the state's approved products list. Some state specifications are very specific about the generic type of

TABLE 2  
SUMMARY OF STATE SPECIFICATION REQUIREMENTS

Property	AASHTO	States
Minimum thickness for rubberized asphalt, mil.	65	50 and 60
Minimum thickness for modified bitumen, mil.	70	50 and 60
Minimum deck or air temperature, °F	35	40, 45, and 50
Puncture resistance, lb	—	40 and 200
Maximum permeance, perms	—	0.10
Minimum longitudinal overlap, in.	2.0	2.0, 2.5, 3.0, 4.0, and 6.0

— = Not specified.

materials that may be used. For example, the Massachusetts specifications allow the use of three types of membranes:

1. Coal tar emulsion reinforced with two plies of coated glass fabric
2. Hot applied rubberized asphalt membrane
3. Preformed sheet systems, either reinforced rubberized asphalt or reinforced tar and resin.

System 2 is not used on grades steeper than 3%, and System 3 is the only system acceptable for butted deck beams and adjacent box beams. For the two plies of coated glass fabric, the first ply is laid transverse to the center line of the bridge and the second layer parallel to the center line. The bituminous concrete protective course is to be applied within 24 hours after the membrane is installed.

Virginia DOT specifications permit five systems:

1. System A—A primer and prefabricated membrane consisting of a laminate formed with suitably plasticized coal tar and reinforced with nonwoven synthetic fibers or glass fibers.
2. System B—A primer, mastic, and prefabricated membrane consisting of a laminate formed with rubberized asphalt and reinforced with synthetic fibers or mesh.
3. System C—A primer and prefabricated membrane consisting of a laminate formed with suitably plasticized asphalt, reinforced with open-weave fiberglass mesh and having a thin polyester top surface film.
4. System D—A hot-poured liquid elastomeric membrane with protective covering.
5. System E—A surface conditioner and a hot-applied rubberized asphalt membrane with protective covering.

Based on the results of the survey and review of state specifications, the following is a summary of practices that are followed:

#### 1. Pre-installation

- Require a manufacturer's representative to be present when work is performed. One state's specifications require that the representative be readily identified with a photo ID badge.
- Require that all work be performed by the manufacturer's certified personnel. It is important that the certified personnel and the manufacturer's representative not be the same person.

#### 2. Surface Preparation

- Ensure that the concrete surface is free of protrusions and rough edges.
- Use abrasive blasting to remove all contamination from the deck, including all material from the previous membrane.
- Do not use water to clean the deck, as the surface must be dry before the primer is applied.
- Clean surface with brooms, vacuum, or compressed air to remove all loose material before applying the membrane system. Some specifications require inspection and approval by the engineer before priming. Other states delegate the responsibility to the manufacturer's representative.
- Reinforce or repair cracks before placing the membrane.

#### 3. Installation of Waterproofing System

- Specify a minimum deck and/or air temperature before applying the membrane. Specified values range from 35°F to 50°F. For heat-welded membranes, one state requires the substrate temperature to be at least 5°F above the dew point.
- Specify a dry deck and application only in dry weather. One state specifies a surface moisture content of less than 6% and requires the contractor to have a calibrated electronic surface moisture meter.
- Use a primer to enhance the bond between the concrete deck and the membrane, where required by the specifications or the manufacturer.
- Install reinforcing membrane over cold joints and cracks in the concrete deck.
- Make a complete seal with the curb up to the depth of the asphaltic concrete overlay.
- Begin placement of preformed membranes on the low point of the deck and provide adequate lap between adjacent strips. This permits water to drain without accumulating against the seams. The

specified minimum overlap for longitudinal seams ranges from 2 to 6 in.

- Stagger membrane overlaps in the transverse direction so that transverse seams do not line up. One state requires that end laps be in the direction of the paving operation.
- Repair any blisters that appear in the membrane before the overlay is placed, per the manufacturer's recommendations.
- Prohibit or minimize traffic on the membrane and allow only rubber-tired vehicles until the overlay is placed, or use protection boards.
- Specify a minimum and maximum time between membrane application and the first layer of overlay placement. The minimum time allows for the membrane to cure properly and depends on the manufacturer's recommendations. The maximum time reduces the length of time that the membrane is exposed to potential damage. Specified values range from 1 to 5 days.
- Use a tack coat to enhance the bond between the membrane and the overlay.

#### 4. Quality Control

- Conduct adhesion bond testing for spray-applied membranes.
- Perform leak testing after the overlay is placed. The easiest time to do this is during a rainstorm. However, the United States does not have a standard test procedure for leak testing.

#### ASTM Standards

The AASHTO and state specifications reference numerous ASTM standards for material specifications and test methods. Table 3 lists the relevant standards identified from the survey and review of state specifications during the development of this synthesis.

ASTM D4071 covers liquid applied, preformed, and built-up membrane systems and their application, including the bituminous wearing course. The practice provides a guide for the factors to be considered prior to waterproofing bridge decks with a membrane system. Guidance for the speci-

TABLE 3  
ASTM STANDARDS RELATED TO WATERPROOFING MEMBRANES

ASTM Designation	Title
D5	Standard Test Method for Penetration of Bituminous Materials
D36/D36M	Standard Test Method for Softening Point of Bitumen (Ring-and-Ball Apparatus)
D41/D41M	Standard Specification for Asphalt Primer Used in Roofing, Dampproofing, and Waterproofing
D146	Standard Test Methods for Sampling and Testing Bitumen-Saturated Felts and Woven Fabrics for Roofing and Waterproofing
D173	Standard Specification for Bitumen-Saturated Cotton Fabrics Used in Roofing and Waterproofing
D449	Standard Specification for Asphalt Used in Dampproofing and Waterproofing
D517	Standard Specification for Asphalt Plank
D882	Standard Test Method for Tensile Properties of Thin Plastic Sheeting
D1228	Methods of Testing Asphalt Insulating Siding Surfaced with Mineral Granules (Withdrawn 1982)
Withdrawn Standard	
D1668	Standard Specification for Glass Fabrics (Woven and Treated) for Roofing and Waterproofing
D1777	Standard Test Method for Thickness of Textile Materials
D3236	Standard Test Method for Apparent Viscosity of Hot Melt Adhesives and Coating Materials
D3515	Standard Specification for Hot-Mixed, Hot-Laid Bituminous Paving Mixtures
Historical Standard	
D4071	Standard Practice for Use of Portland Cement Concrete Bridge Deck Water Barrier Membrane System
D4541	Standard Test Method for Pull-Off Strength of Coatings Using Portable Adhesion Testers
D4632	Standard Test Method for Grab Breaking Load and Elongation of Geotextiles
D4787	Standard Practice for Continuity Verification of Liquid or Sheet Linings Applied to Concrete Substrates
D6153	Standard Specification for Materials for Bridge Deck Waterproofing Membrane Systems
D6690	Standard Specification for Joint and Crack Sealants, Hot Applied, for Concrete and Asphalt Pavements
E96/E96M	Standard Test Methods for Water Vapor Transmission of Materials
E154	Standard Test Method for Water Vapor Retarders Used in Contact with Earth Under Concrete Slabs, on Walls, or as Ground Cover

cation of materials, application of membrane systems, and placement of the bituminous wearing surface is provided. The standard is more of a checklist of items to address than a standard specification that spells out all the details.

**Canadian Specifications**

The specifications from six Canadian provinces were reviewed for this synthesis. In general, the different specifications contain similar provisions although the degree of detail varies. The Ontario provincial specification OPSS 914, *Construction Specifications for Waterproofing Bridge Decks with Hot Applied Asphalt Membranes (10)* provides the most details, including separate specifications for the hot applied rubberized asphalt membrane and the protection board.

The U.S. and Canadian specifications have three major differences.

- Canadian specifications generally require the use of hot applied rubberized asphalt for waterproofing membranes, whereas U.S. specifications permit other types of membranes.
- Some Canadian specifications require rubber membranes or reinforcing fabric to be installed over cracks and joints before the asphalt membrane is applied, as shown in Figure 5.
- Most Canadian specifications require the use of protection board on top of the waterproofing membrane.

**United Kingdom Practices**

In 1999, the United Kingdom Department for Transport (UKDOT) formally issued BD47/99, *Waterproofing and Surfacing of Concrete Bridge Decks (11)*. This standard gives the requirements for the design, materials, and workmanship for the waterproofing and surfacing of concrete decks for highway bridges. It specifies that decks of high-

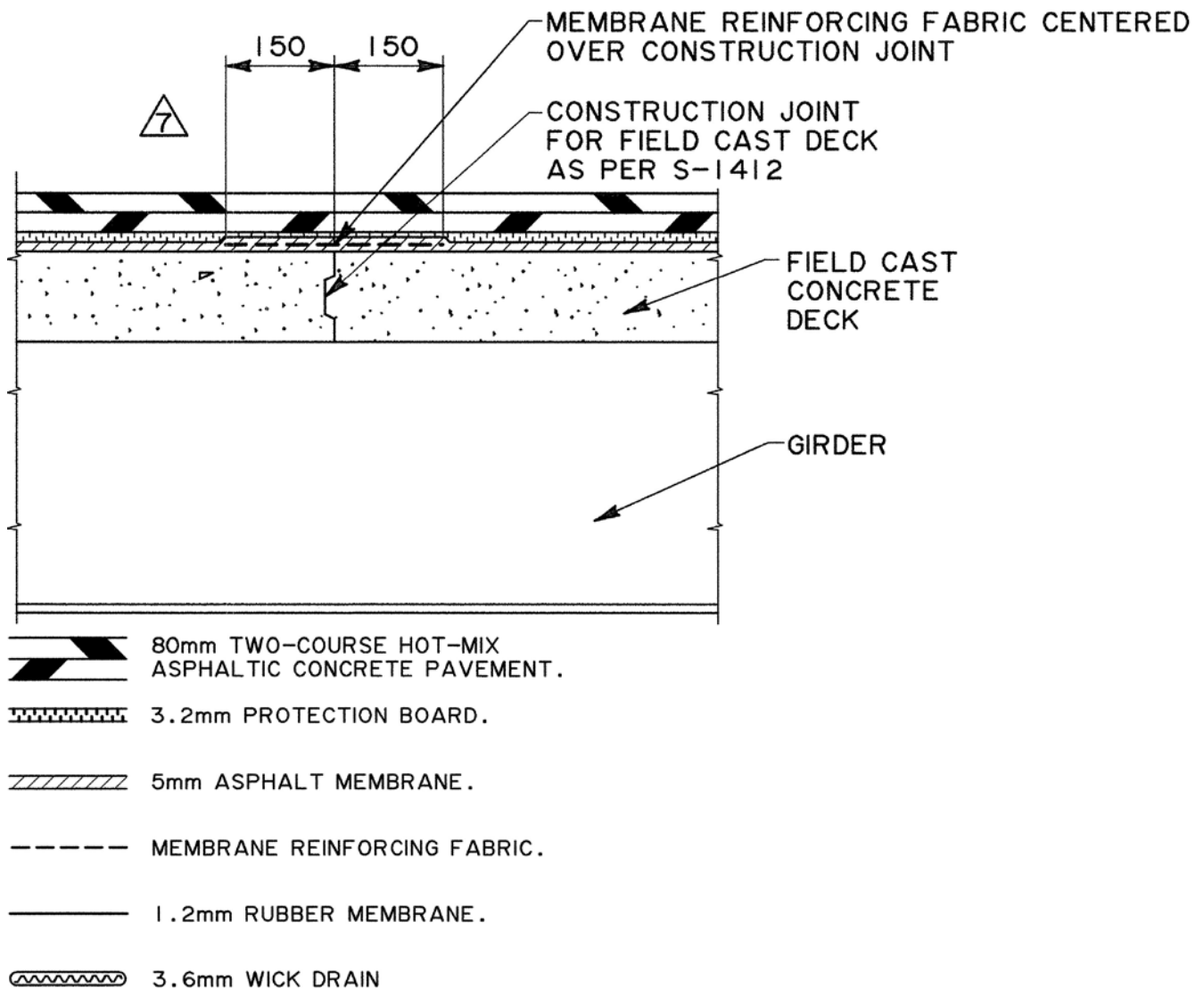

FIGURE 5 Waterproofing over joints and cracks (150 mm = 6 in.) [Source: Alberta Transportation].

way bridges be protected to prevent surface water from coming into direct contact with the structural deck. This is achieved by providing adequate drainage and by waterproofing the upper surface of the deck. The waterproofing has to be sufficiently robust to resist transient vehicle loading, maintain good adhesion to the deck and the surfacing, be resistant to deicing salts, and possess long-term durability. Waterproofing systems are required to have a British Board of Agrément Roads and Bridges Agrément Certificate or European equivalent before they may be installed on concrete bridge decks. The required tests for certification include tests on unbonded sheets, boards, and the film of liquid-applied membranes and tests on waterproofing membranes or systems bonded to concrete. In addition, a site trial is required after all laboratory tests have been successfully completed. BD47/99 (11) gives details of the tests and site trials.

The standard does not permit the use of ventilating layers, partial bonding, or bond breakers with the waterproofing system. All systems are to be terminated in a chase. Where a prefabricated system is terminated in a chase, the rebate (return) is to be filled with a compatible sealant. Where a liquid-applied membrane is used, the membrane is to be taken into the chase but a sealant is not required. The membrane is to be protected from subsequent construction operations with a 20-mm (0.8-in.) nominal thickness of additional protective layer consisting of bituminous material. The standard also requires that new bridge decks be protected by a designed total minimum thickness of 100 mm (4 in.) of asphalt, excluding the thickness of the waterproofing system and the additional protective layer.

According to the United Kingdom Waterproofing Association website (12), the use of sheet membrane systems has been superseded by more modern liquid sprayed systems. It reports that the liquid systems consist of three elements:

- Primer used to penetrate and seal the concrete surface and enhance the bond of the membrane;
- Membrane applied in one or two coats; and
- Tack or bond coat to enhance the bond to the riding surface material.

The association states that systems based on methyl methacrylate and polyurethane resins have proved successful.

## SELECTION CRITERIA

In the survey for this synthesis, 17 of 32 agencies (53%) that use membranes reported that they have criteria for when waterproofing membranes are used on new bridge decks. The corresponding response for existing bridge decks was 20 of 33 (61%). The range of criteria was broad, and included the following:

- Whenever an asphalt overlay is used.
- When replacing an asphalt overlay on an existing bridge at a location with freeze-thaw cycles.
- Not allowed on bridges with average daily traffic more than 10,000 vehicles or interstate bridges.
- Temporary overlay on existing bridge deck until funds are available to replace the deck.
- Only for new construction using adjacent box beams or cored slabs and average daily traffic less than 1,000 vehicles.
- When bridge deck condition rating is less than 6, chloride content is minimal, and an asphalt overlay is practical.
- Standard practice for all new bridge decks.
- Standard practice for rehabilitating existing bridge decks.

In summary, the criteria range from standard practice for all new or existing bridge decks to temporary fixes for existing bridge decks.

Agencies were asked in the survey if they had specific reasons for selecting a particular membrane system. Twenty-two of 31 agencies (71%) replied that they did. Figure 6 summarizes their reasons.

The predominant reasons for selecting a particular membrane were track record of previous installations, cost, and desired service life.

In response to the survey, New Hampshire reported that from the 1970s until about 2000, it used peel-and-stick barrier systems. Since then, heat-applied membranes have been used on essentially every bridge deck built or rehabilitated. Spray-applied membranes were used from 1997 to 2005, but contractors now use heat-applied membranes. For bridges longer than about 100 ft, the machine method of applying the membrane is used. Otherwise, the membrane is manually rolled out and heated with a torch to apply enough heat to develop adequate bond.

## DESIGN DETAILS

### North America

In the survey for this synthesis, agencies were asked what standard details they have relating to the installation of waterproofing membranes. Figure 7 presents their responses. Fourteen of the 25 U.S. state agencies (56%) that responded to this question indicated that they had no standard details for the items listed. In contrast, only two of nine Canadian provinces (Prince Edward Island and Saskatchewan) reported not having any. Several provinces have details available as part of their standard drawings, as illustrated in Figure 8.

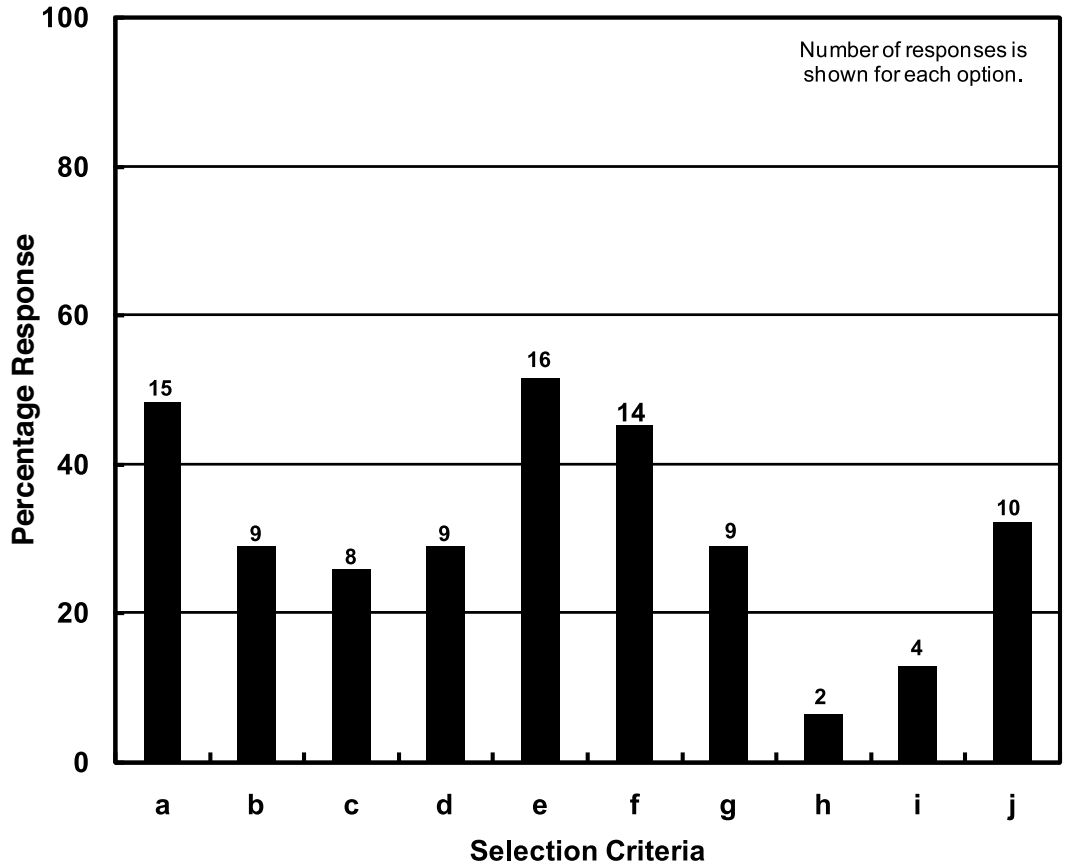

FIGURE 6 Reasons for selecting a particular membrane system.

- a. Cost
- b. Speed of installation
- c. Staged construction options
- d. Surface preparation
- e. Track record of previous installations
- f. Desired service life
- g. Availability
- h. Coordination requirements
- i. Product support
- j. Other

Agencies were also asked what products were used in conjunction with waterproofing membranes. Figure 9 presents their responses. More than 60% of the respondents use primers applied to the concrete and a tack coat before application of the asphalt. The products included under “Other” in Figure 9 were manufacturer’s recommendations, bleeder pipes, wick drains, and membrane reinforcing fabric.

No respondents used venting layers, and only a few used separate adhesive to bond the membranes. Only one respondent reported the use of seepage layers to allow water that penetrates through the asphalt to drain more easily. Although 29% of the respondents indicate the use of protection board, 25% were Canadian provinces. Only one U.S. state (New Hampshire) reported its use, indicating a major difference between U.S. and Canadian practices.

**Europe and Asia**

A 1995 scanning review of European bridge structures identified the use of bridge deck waterproofing systems as a significant observation (13). The following system from top to bottom was reported to be used in Denmark:

- 40-mm (1.6-in.) thick wearing course of asphalt concrete or stone mastic asphalt,
- 40-mm (1.6-in.) thick binder course of modified asphalt concrete,
- 15- to 20-mm (0.6- to 0.8-in.) thick drainage layer of open-graded asphalt concrete,
- Two polymer-modified bitumen sheets fully bonded to the concrete, and

- Epoxy-with-sand prime coat applied to the concrete deck after cleaning with abrasives.

The prefabricated bitumen sheets are heated with an open flame, partially melting them, to bond them to the epoxy-primed concrete bridge deck and to other overlapping sheets. The system is expected to provide a 30-year service life with

appropriate maintenance. The contractor is required to warrant the deck protection system for 5 years.

In France, the scanning review reported that all bridges received waterproofing consisting of mastic asphalt, either epoxy or polyurethane resins, a proprietary system of prefabricated sheets, or a proprietary system (13). Two types of mas-

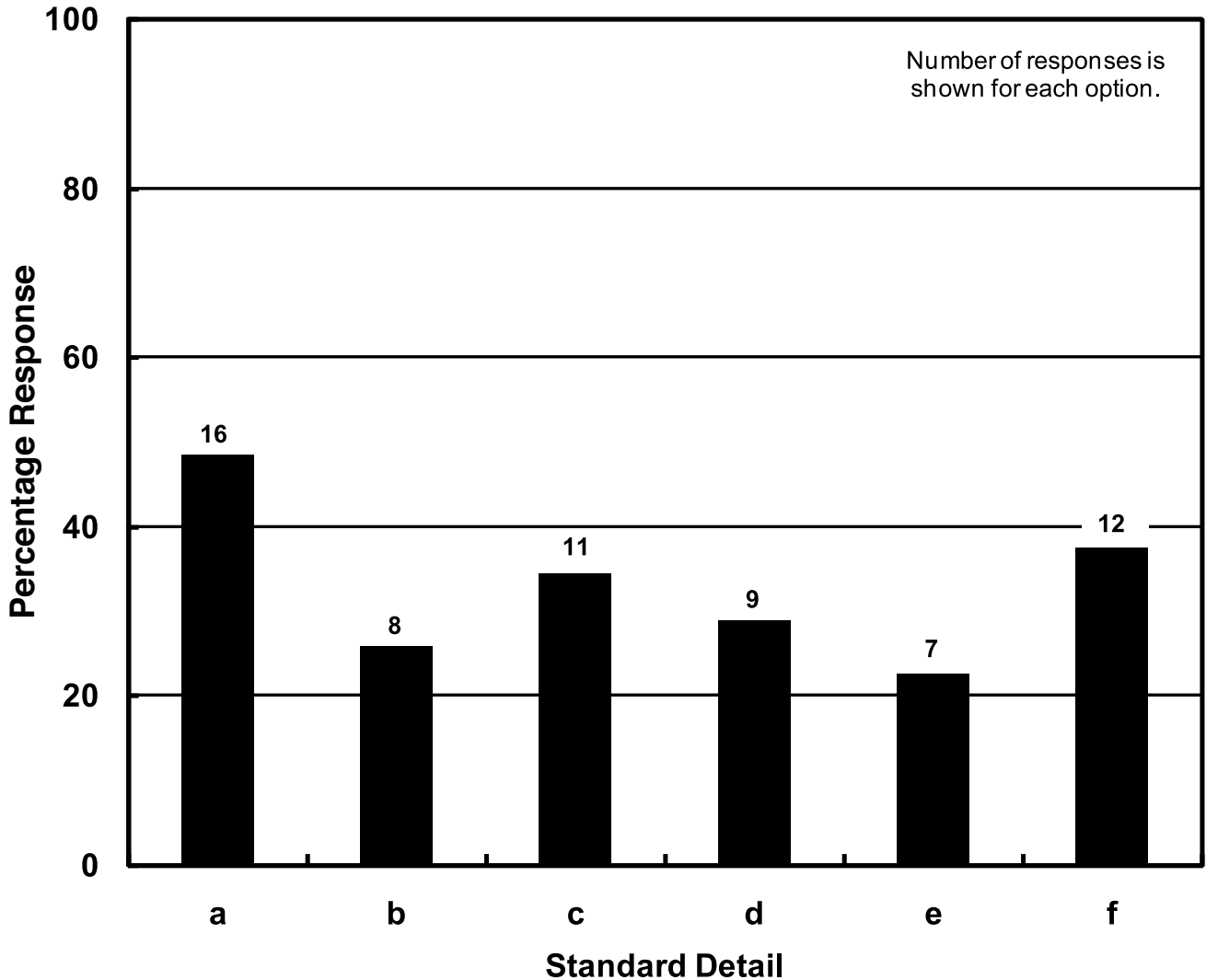
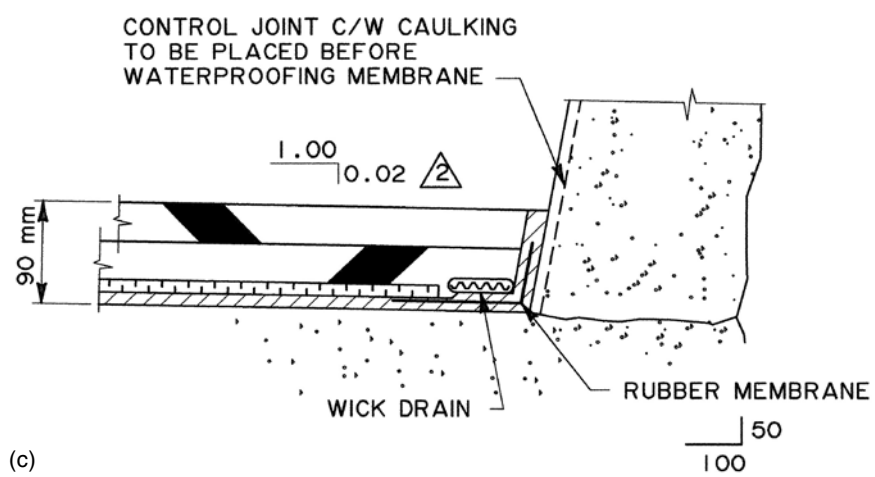
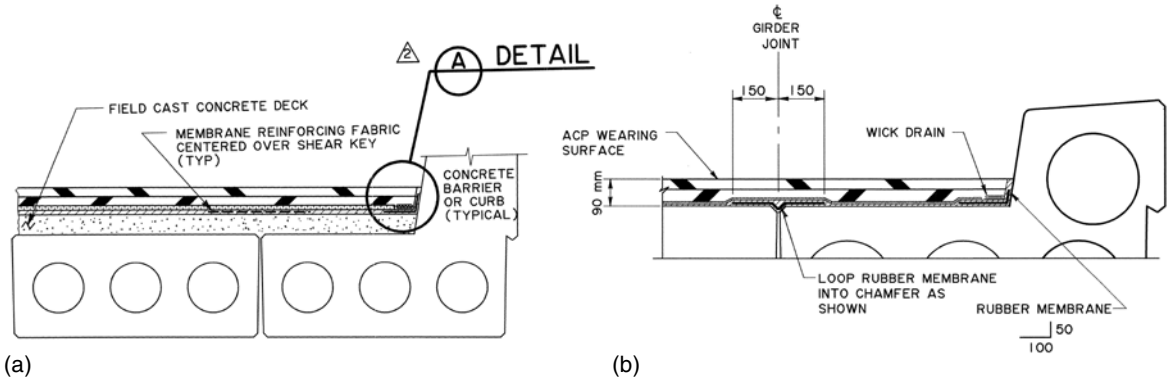

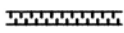

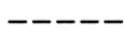

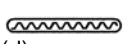

FIGURE 7 Standard details available for the installation of waterproofing membranes.

- Installing waterproofing membranes
- Terminating edges of membranes
- Curb details for membranes
- Concrete barrier details for use with membranes
- Over construction joints
- At expansion joints





- (d)
-  80mm TWO-COURSE HOT-MIX ASPHALTIC CONCRETE PAVEMENT.
  -  3.2mm PROTECTION BOARD.
  -  5mm ASPHALT MEMBRANE.
  -  MEMBRANE REINFORCING FABRIC.
  -  1.2mm RUBBER MEMBRANE.
  -  3.6mm WICK DRAIN

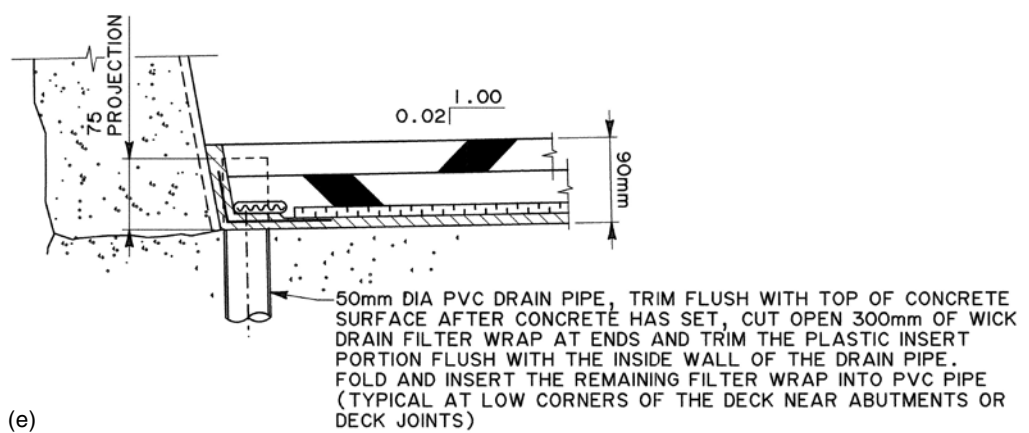

FIGURE 8 Examples of details provided in standard drawings: (a) Composite deck, (b) Noncomposite deck, (c) Detail A, (d) Legend, (e) Drain pipe detail [Source: Alberta Transportation].

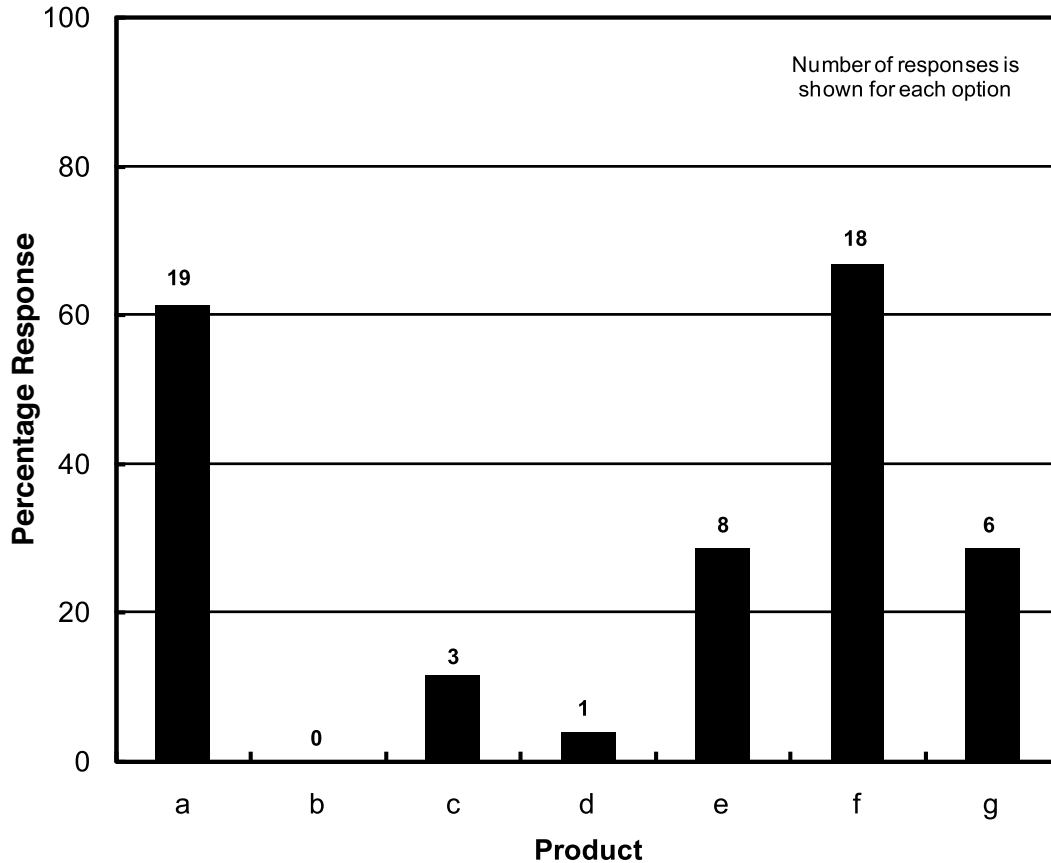

FIGURE 9 Products used in conjunction with waterproofing membranes.

- a. Primers applied to the concrete
- b. Venting layers
- c. Separate adhesives to bond the membrane
- d. Seepage layers
- e. Protection board
- f. Tack coat
- g. Other

tic asphalt were used. One type consisted of an 8-mm (0.3-in.) thick layer of naturally occurring bituminous limestone mixed with refined bitumen applied over a dry surface primed with a tack coat. The system was topped with a 22-mm (0.9-in.) thick layer of asphalt mixed with gravel. The other type consisted of a layer of 4-mm (0.2-in.) thick polymer asphalt mastic followed by a 26-mm (1-in.) thick layer of asphalt and gravel. The sheets were similar to those used in Denmark and consisted of polymer-modified bitumen reinforced with nonwoven polyester.

The scanning review also reported on a proprietary system that consisted of the following from top to bottom (13):

- Layer of slate flakes to protect the membrane,
- 2-mm (0.1-in.) thick membrane of asphalt,
- 15- to 30-mm (0.6 to 1.5-in.) thick layer of bitumen, and
- Elastomer-modified emulsion.

A 1997 scanning review of Asian bridge structures identified the use of a waterproofing membrane below the asphalt

in Japan and the use of liquid membranes and preformed sheet membranes in South Korea (14). This report did not provide details of these systems.

A 2003 scanning study recommended a research project to study the success of waterproofing measures for protecting reinforced concrete members (15).

A 2004 scanning study identified the use of a multiple-level corrosion protection system in Germany (16). The system shown in Figure 10 consists of the following layers of material from top to bottom:

- Asphalt wearing surface: 35- to 40-mm (1.4- to 1.6-in.),
- Asphalt protective layer: 35- to 40-mm (1.4- to 1.6-in.),
- Bituminous fabric sheet material welded to the concrete deck by heat and pressure: 4.5- to 8-mm (0.18- to 0.31-in.),
- Epoxy-coating primer, and
- Concrete cover to the steel reinforcement: 40-mm (1.6-in.).

The system was reported to have been in use since the mid-1980s. Previously, a system of asphalt overlay on a sheet of mastic or glass fleece had been used, but it did not provide the necessary protection against the ingress of water containing deicing salts.

A 2009 scanning study reported that the use of waterproofing membranes on concrete decks for corrosion protection with epoxy underneath to seal cracking in the young concrete is standard practice throughout Europe (1). The use of waterproofing membranes on integral and continuous bridges is mandatory in the United Kingdom. Its engineers were reported to be highly confident of the enhanced performance that waterproofing membranes can provide and do not believe that other deck protection strategies can preclude the use of membranes. The standard deck design in the United Kingdom consists of 8- to 10-in. thick decks with a waterproofing membrane overlaid with asphalt. European practice, however, is not to use bare concrete decks or decks reinforced with epoxy-coated, stainless steel clad, or solid stainless steel bars.

The 1995, 2004, and 2009 scanning studies recommended that further consideration be given to implementing the use of European waterproofing membrane systems in the United States (1, 13, 16).

## CONSTRUCTION AND INSPECTION

According to the specifications reviewed for this synthesis, bridge deck waterproofing generally consists of the following steps:

1. Deck surface preparation,
2. Application of a primer to the concrete,
3. Installation of the waterproofing membrane,
4. Installation of protection board if used,
5. Repair of unacceptable areas resulting from membrane thickness inadequacies, and
6. Installation of asphaltic concrete riding surface.

Figures 11 and 12 show various steps in the installation process.

Results from the survey for this synthesis showed that 19 of 31 agencies (31%) have specifications for the surface preparation of new concrete bridge decks prior to application of the waterproofing membrane system, and 26 of 32 (81%) have them for existing bridge decks. These numbers reflect that more agencies use waterproofing membranes for existing bridge decks than for new bridge decks. In general, the specifications require that the concrete surface be free of protrusions or rough edges, all contamination be removed, and the surface be cleaned of all loose material without the use of water.

Most specifications do not go into the means and methods to achieve the desired concrete surface. However, the New Hampshire specifications for surface preparation for use with heat-welded and liquid-spray barrier membranes provide more details. The specifications require that the deck be shot-blasted

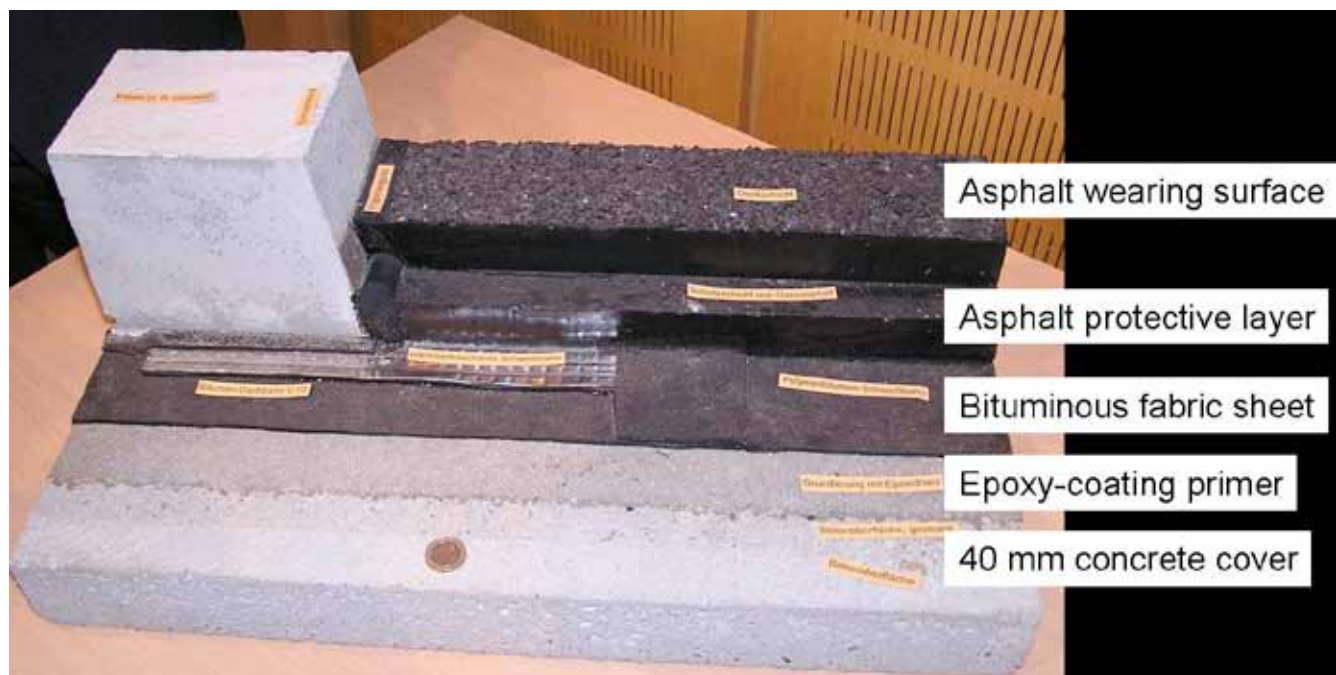

FIGURE 10 Bridge deck multiple-level protection system (16).



(a)



(b)



(c)



(d)



(e)



(f)

FIGURE 11 Steps in the installation of a preformed sheet membrane: (a) Application of primer to the concrete deck, (b) Laying out the sheet membrane, (c) Heating the sheet membrane with a torch, (d) Sealing the overlap seams with a hand roller, (e) Completed membrane, (f) Compacting the hot mix asphalt [Source: Photos courtesy of Soprema for a, b, c, and e; New York State DOT for d and f].



(a)



(b)

FIGURE 12 Application of a liquid membrane: (a) Hand spraying, (b) Machine spraying [Source: Photos courtesy of Stirling Lloyd for a; New York State DOT for b].

using self-contained, self-propelled equipment to achieve a consistent anchor profile that is free of sharp protrusions. The abrasive media must consist of shot and grit sufficient to provide an angular surface profile that satisfies the requirements published by the International Concrete Repair Institute (17). Areas that are not accessible to self-propelled shot-blasting equipment are to be blasted with mineral grit or steel grit and air pressure sufficient to achieve the specified surface profile. The use of today's machinery for deck preparation and the availability of guidelines are improvements in both productivity and technology since *NCHRP Synthesis 220* was published in 1995.

The Saskatchewan specifications for surface preparation require that the concrete deck have spray-painted reference marks. Surface preparation is considered acceptable when the shot-blasting effort removes the painted reference marks completely from the concrete surface.

Thirteen of 32 agencies (41%) have special inspection practices during installation of waterproofing membranes. Reported practices included monitoring, inspecting, or measuring surface preparation, membrane temperature, installation of protection boards if used, and conformity to standard drawings and specifications.

## PERFORMANCE

Sohanghpurwala (18) described the advantages of membranes as follows:

- Membranes can be applied relatively rapidly, including application of the asphalt wearing surface.
- Membranes can bridge and prevent reflection of most moving cracks.
- The asphalt wearing surface can provide a good riding surface.
- Membranes can be applied to almost any deck geometry.

He also described their limitations:

- The service life of the membranes may be limited by the wearing surface life.
- The system is not suitable for grades greater than 4% because bond capacity is limited for some systems and shoving and debonding can occur.

The ideal waterproofing system should satisfy the following criteria:

- Impermeable to water,
- Good adhesion to the deck,
- Good adhesion to the protective riding surface,
- Tolerant of deck surface roughness,
- Resistant to traffic before application of the riding surface,
- Capable of bridging cracks in the concrete deck or opening of joints between adjacent precast members,

- Safe to apply and with low volatile emissions,
- Able to withstand high and low temperatures,
- Can be applied over a wide range of temperatures, and
- Extended service life of 50 to 100 years.

He also listed the following performance criteria for waterproofing membranes:

- Chloride ion permeability: Protection of concrete from chloride ion intrusion is a major requirement for membranes. The report suggests that concrete that is waterproofed with a membrane be tested for permeability in accordance with the modified version of AASHTO T-277, Rapid Chloride Permeability Test, and the charge passed should not exceed 100 coulombs.
- Low-temperature flexibility: Membranes need to possess adequate flexibility to withstand the stresses caused by deck movements at low temperatures. No visible damage should occur when wrapping a sample of membrane around a 1-in. diameter mandrel at 9°F.
- Crack bridging: Cracks already in existence on the bridge deck will grow with temperature and load changes; the membrane must have elastic properties to be able to accommodate changes in width. The report suggests that membranes be able to bridge a crack width of 0.06 in. at 32°F.
- Bond strength: A strong adhesive bond between the membrane and wearing surface reduces deformation of the hot mix asphalt wearing surface layer by heavy wheel loading. The adequacy of the bond should be evaluated in both tension and shear, with minimum allowable values of 690 kPa (100 psi) and 172 kPa (25 psi), respectively.
- Resistance to indentation: Because of the thermoplastic nature of some membranes, indentation and puncture by aggregates may occur during application and rolling of the hot mix asphalt wearing surface. Testing for resistance to indentation should result in no penetration at the expected maximum placement temperature.

In the survey conducted for this synthesis, agencies were asked to identify the expected service lives of the waterproofing membranes they have used. Figure 13 presents the results. Most agencies expected 16 to 20 years for new bridge decks and 6 to 20 years for existing bridge decks. Based on the information supplied, it was not possible to determine whether prefabricated systems or liquids systems last longer.

From the survey, the basis for the expected service lives can be summarized as follows:

- Expected life of the asphalt overlay,
- Past performance experience,
- Deck condition at time of installation, and
- One or two paving cycles with partial depth replacement of the asphalt.

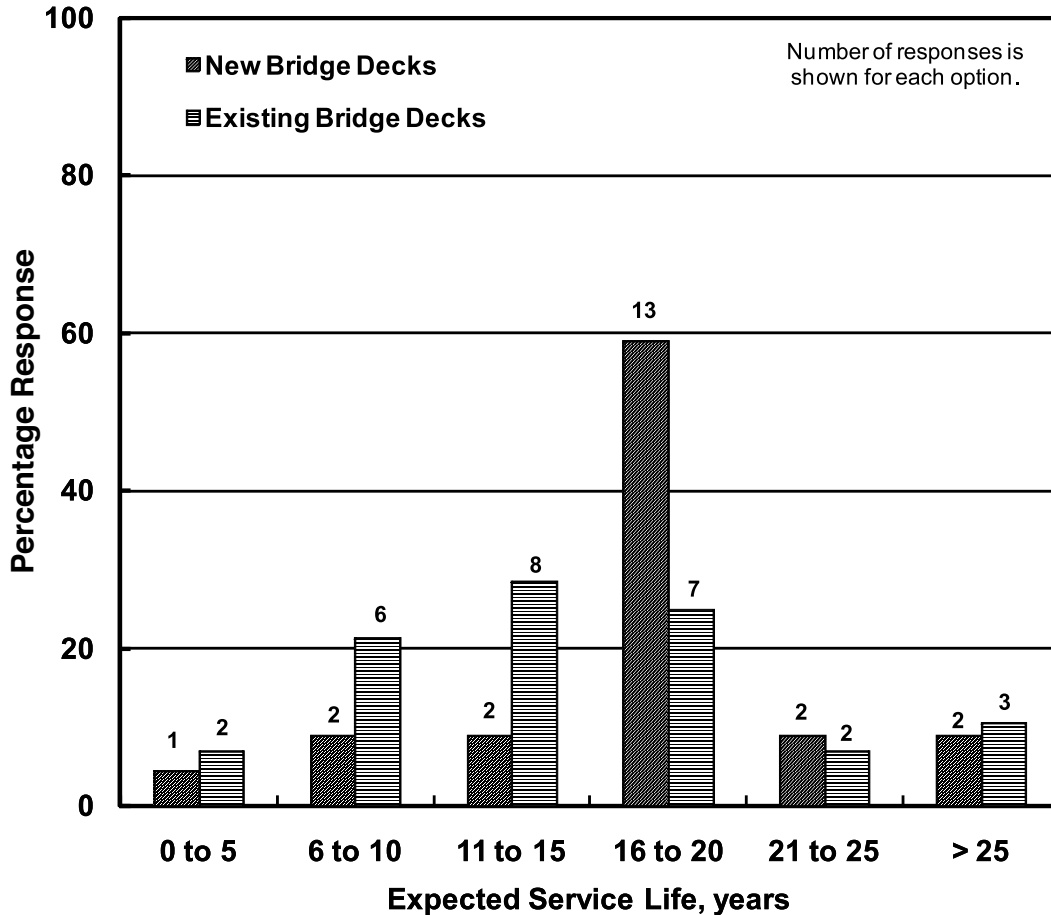

FIGURE 13 Expected service life of waterproofing membranes.

Many agencies reported that the life of the membrane system is limited by the life of the asphalt. Sohaghpurwala (18) reported that the service life of hot mix asphalt with a preformed membrane would be less than 10 years if the overlay failed when used to extend the service life of existing bridge decks. Otherwise, the service life would be 25 years.

Many types of defects may occur with waterproofing membrane systems used on new or existing concrete bridge decks. Figure 14 summarizes the defects that agencies reported in the survey.

From the data shown in Figure 14, defects are more likely to occur when membranes are used on existing bridge decks than on new bridge decks. The defects most agencies reported were lack of adhesion between the membrane and the deck and between the membrane and the asphalt. In addition, about half of the agencies that use membrane systems reported moisture penetration through the membrane without knowing the cause. Debonding of the membrane from either the concrete or asphalt is almost impossible to detect until it becomes evident through some defect on the asphalt surface. In contrast, water penetrating through the membrane and appearing on the underside of a bridge deck can be observed readily by deposits on the underside of the

bridge deck or beams when adjacent members are used. Defects listed as "Other" in Figure 14 included spalling and deterioration of the concrete deck below the membrane and insufficient thickness of membrane material.

Xi et al. (19) reported on the inspection and evaluation of 16 bridges in Colorado that used a variety of corrosion protection methods, including 6 with asphalt membrane overlay. These bridges were constructed between 1958 and 1985. It is not reported when the asphalt membranes were placed. On one bridge that was repaired in 1978, the authors observed severe delamination and cracking of the membrane with significant reinforcement corrosion. Another bridge constructed in 1983 was reported to be in excellent condition. Other bridges had corrosion of the bridge deck reinforcement. On the basis of the inspection of all bridges, the authors found that the results were inconclusive for determining whether epoxy-coated reinforcement, corrosion inhibitors, or membranes were the best solution.

In 1985, two bridge decks in Kansas were restored using a nonwoven polypropylene membrane over an asphalt cement tack coat and topped with a 2-in.-thick wearing surface of hot mix asphalt (20). Annual surveys of these bridges consisted of visual inspection, chain drags to check for delami-

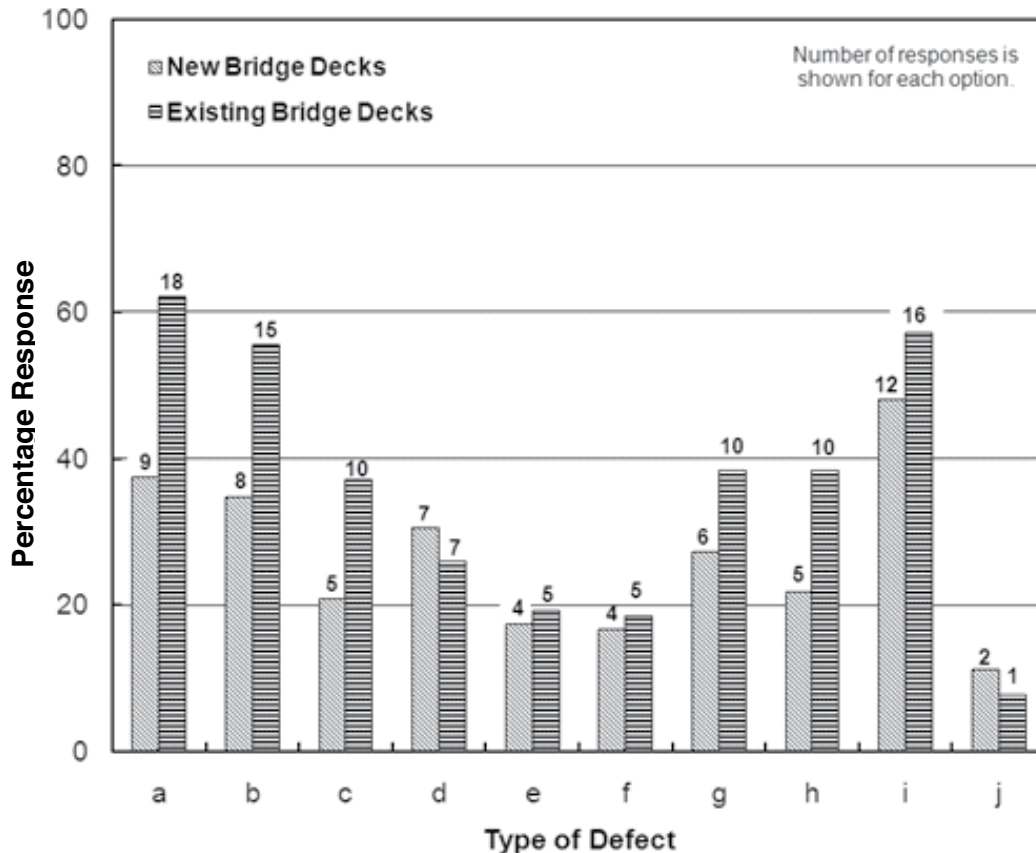

FIGURE 14 Observed types of defects in waterproofing membrane systems.

- a. Lack of adhesion between the waterproofing membrane and the concrete deck
- b. Lack of adhesion between the waterproofing membrane and the asphalt surface
- c. Punctured waterproofing membranes
- d. Membrane blistering
- e. Horizontal shear failure at the membrane
- f. Cracks in the waterproofing membrane
- g. Voids under the waterproofing membrane
- h. Reinforcement corrosion
- i. Moisture penetration through the membrane but cause unknown
- j. Other

nations, resistivity readings, and crack measurements. The bridge decks were 14 and 15 years old at the time of their restoration. Fourteen years after installation, both decks receive ratings of “good” from the Kansas Department of Transportation (KDOT) bridge management inspectors.

These results are consistent with an earlier report (21) that looked at the condition of six bridge decks with asphalt interlayer membrane overlays installed between 1967 and 1971 after 20 to 25 years in service. Three different types of membranes were used: a preformed coal tar and polypropylene sheeting, a coal tar modified polyurethane elastomer membrane covered with an asphalt roofing sheet, and a nonwoven polypropylene fabric. All three types of membranes were overlaid with hot-mix asphalt. The system using the nonwoven polypropylene membrane was the most effective.

According to Distlehorst (20), Kansas currently uses asphalt membrane overlays only as a rehabilitation measure on existing bridge decks in very bad condition to extend the service life by 3 to 5 years. This was confirmed by the KDOT response to the survey for this synthesis. KDOT also uses asphalt membrane overlays to reduce the added dead load when deck rehabilitation is needed on bridges with total load limitations (20).

#### COSTS

Kepler et al. (8) compared the life cycle costs of 33 different corrosion protection systems and concluded that the use of hot rubberized asphalt membrane was the second-lowest-cost strategy, with assumed discount rates of 2% and 4%. At



a 6% discount rate, hot rubberized asphalt membrane was the sixth-lowest-cost strategy. The analysis was based on a service life of 75 years and assumed that the top 40 mm (1.6 in.) of the asphalt overlay was replaced at 20 and 60 years and the membrane and asphalt overlay replaced at 40 years.

Hearn and Xi (22) evaluated the relative costs of the following four types of protection of reinforcement in bridge decks:

- Uncoated reinforcing bars with rigid overlay,
- Epoxy-coated reinforcing bars and a concrete surface sealer,
- Uncoated reinforcing bars protected with a waterproofing membrane and bituminous overlay, and
- Epoxy-coated reinforcing bars protected with a waterproofing membrane and bituminous overlay.

The history of 82 bridge decks built between 1969 and 1991 was used to estimate the service life and to generate population models of service life. Costs were computed as present value, discounted annualized cost, and annualized cost without discount factors. Discount factors ranging from 2% to 10% were used. By all present value and annualized cost measures, decks with waterproofing membranes were the least expensive. This conclusion was not sensitive to the value of the discount factor but was influenced in part by the longer service life predicted for bridge decks with membranes.

Distlehorst (20) provided estimates of relative annual costs of bridge deck overlays used in Kansas. She compared

the cost of retrofit epoxy-coated reinforcement, Iowa system overlays, Kansas system overlays, and membrane overlays. She concluded that the membrane overlays, with an average cost of \$0.12/ft<sup>2</sup>/year of service life based on 1979 dollars, were the most cost-effective rehabilitation technique.

Liang et al. (23) reported that preformed sheet membranes with asphalt overlays have been used in Colorado. Hot rubberized asphalt membranes and spray-applied liquid membranes are less expensive than preformed sheet membranes.

In the survey for this synthesis, agencies were asked to provide unit costs for labor, equipment, and materials for waterproofing membranes systems used on new and existing bridge decks. The reported data showed a wide variation of costs within each state and between states. In the United States, reported bid prices ranged for \$0.56 to \$42.80/ft<sup>2</sup>. In Canada, reported costs ranged from C\$1.69 to C\$8.55/ft<sup>2</sup>.

## REPAIRS

In the survey for this synthesis, agencies were asked if they had requirements or specifications for repair of membrane systems. Most respondents who answered this question indicated that they do not repair damaged membranes but would replace a part or all of the system depending on the severity of the damage. Any damage caused before the asphalt overlay was placed would be repaired per the manufacturer's recommendations.

## TESTING AND RESEARCH

### LABORATORY TESTING

At the request of the New England Transportation Consortium, the U.S. Army Cold Regions Research and Engineering Laboratory conducted laboratory studies to develop standardized procedures for the evaluation of bridge deck membranes (24). They reported that although there are ASTM tests to evaluate various engineering properties of tape, rubber, roofing, plastics, and geomembranes, there is no group of standards or ways to interpret them that all manufacturers follow when reporting performance data for their products. The intent of the work was to recommend tests to compare membranes. Six sheet products were tested to measure adhesion, tensile strength and elongation, puncture resistance, and water vapor permeability. Liquid membranes were not included in the scope of the study. Conclusions based on testing and analyses included the following:

- A membrane does not have to be perfectly adhered to the deck to avoid blistering.
- High bond strength matters less than continuity of bond.
- The smallest void size that can originate a blister is about the size of a quarter.
- Elongation rather than strength is a more appropriate property to judge a membrane's ability to span a crack.
- Puncture resistance is an important property of a good sheet membrane.
- ASTM E96 Procedure B (Water Method) is an acceptable method to measure water vapor permeability.

The authors stated that even though laboratory tests can help rank membranes according to individual properties, exposure to the complex combination of natural forces is essential for proving a material's durability.

The European Organisation for Technical Approvals has a report that describes a method for determining the resistance of liquid-applied bridge deck waterproofing member to chloride ion penetration following the indentation of the membrane by simulated hot asphalt (25). In this method, three heated concrete blocks with the membrane applied are indented at four locations using a heated 8-mm (0.3-in.) diameter truncated cone applied at a specified rate until a maximum force is applied. The surface of the membrane is

then exposed to a saturated sodium chloride solution for 28 days. A sample of the concrete directly below the membrane is then obtained from each block and chloride ion concentration determined. The measured chloride ion concentration is then compared with the background chloride ion concentration of the reference concrete block.

### EVALUATING FIELD INSTALLATIONS

Manning (5) described various methods to evaluate waterproofing systems in the field, including visual inspection, electrical methods, embedded devices, physical sampling, ultrasonic methods, and air permeability methods. These same techniques still exist today, though many have been improved through the use of electronics and automation to make them more practical to use on large areas of bridge decks.

One of the challenges of detecting defects is that the defect has to be large enough to be detected using the selected method. If the defect is small, it is like looking for a needle in a haystack. If the defect is large, it may be detected by visual observation of surface defects such as delaminations or water leakage through the deck.

Seven agencies responding to the survey reported that they had used the following nondestructive test methods to assess the condition of the in-place waterproofing systems:

- Visual inspection,
- Electrical conductivity or electrical resistance,
- Ground-penetrating radar (GPR),
- Chain drag or hammer sounding, and
- Leak testing.

### Visual Inspection

Visual inspection requires observation of the top and bottom surfaces of the bridge deck from a relatively close position, such as walking on the deck surface. With this method, the condition of the membrane cannot be directly observed. The most direct method would be observation of the deck underside after a period of rain to check for wet spots or efflorescence. Rust stains or spalled concrete may also be evident, but by the time these are visible, active corrosion has been ongoing for some time.

In Denmark, where more than 85% of the bridge deck area has a bitumen overlay and waterproofing membrane, invasive inspections are sometimes performed on bridge decks. An area of wearing course and membrane approximately 0.8 x 0.8 m (30 x 30 in.) is removed so the condition of the structural concrete deck can be inspected (15). A similar procedure is followed in Sweden when deterioration is observed at the deck surface.

Visual inspection of the asphalt surface may offer some indications of the condition of the membrane. Wide cracks, radial crack patterns, wet spots, and gaps at curbs or barriers may be signs of potential problems.

### Electrical Methods

Virginia's standard specifications require that the waterproofing effectiveness of the membrane system be determined in accordance with Virginia Test Method T 39. In this test method, the electrical resistance between the top surface of the asphalt and the top mat of reinforcement is determined using an ohmmeter. The specification requires a minimum resistance of 500,000 ohms. Areas having a lower resistance are to be repaired if determined by the engineer to be detrimental to the effectiveness of the system. If more than 30% of the deck area is determined to be detrimental to the effectiveness of the system, the membrane is to be replaced.

Washington State has a similar procedure, Test Method T 413. The scope of the method indicates that it may be used for either membrane alone or membrane-pavement combination. The use of the method has been discontinued because of difficulty in training staff to use it and because membranes rarely failed the test. Interestingly, McKeel (26) commented on Virginia's T 39 method that a great deal of judgment is necessary to perform the test and it is advisable to use the same crew as much as possible. Manning (5) also points out that low resistivity readings are not necessarily associated with defects in the membrane but may be the result of moisture in the surface layers.

ASTM D3633, *Standard Test Method for Electrical Resistivity of Membrane-Pavement Systems*, is similar to Virginia's T 39 method and Washington State's T 413 method and may be used to measure the electrical resistance between the saturated top surface of the system and the reinforcing steel embedded in the concrete.

### Ground-Penetrating Radar

GPR consists of transmitting pulses of radio frequency energy into the deck and recording the reflected signal. Reflections occur from each interface where there is a change in the dielectric constant, such as at voids, cracks, or steel reinforcement. The use of GPR for evaluating subsurface conditions was the subject of *NCHRP Synthesis 255*

(27). That synthesis reported that GPR is a noninvasive and nondestructive tool that has been used successfully in transportation structures for applications such as profiling asphalt thickness, detecting air-filled voids, and determining reinforcement spacing and depths in concrete. However, no published papers about the use of GPR to evaluate waterproofing membranes were identified for this synthesis.

Kansas reported on the use of GPR on a bridge with a waterproofing membrane. Based on the results, Kansas decided to rehabilitate the bridge deck. The deterioration levels found in the concrete during the rehabilitation work were much higher than expected, and near full-depth patching was needed throughout most of the deck. The final rehabilitation cost was almost as high as the estimated cost for complete deck replacement.

### Chain Drag and Hammer Soundings

Chain drag and hammer soundings are simple techniques to detect delaminations in bridge decks. In both methods, the change in sound from dragging chains across a deck or striking a local area with a hammer is used to identify areas of delaminations. The method is labor-intensive and is not foolproof.

### Leak Testing

Leak testing involves ponding the deck top surface with water and checking underneath for leaks. This method may not be feasible on some bridge decks owing to longitudinal or transverse slopes. Oregon requires leak testing as soon as the deck is ready for traffic. No water leakage is allowed.

Missouri reported that it has recently started to do leak testing on newly constructed adjacent box beam bridges. In some instances, it has flooded the deck before waterproofing to establish which joints leak or after the membrane and asphalt overlay have been placed and prior to bridge opening. Missouri reported that the best way to perform the test is during a rainstorm. This approach does not delay the project or impact traffic but is dependent on the weather.

### Bond Testing

The New Hampshire special provisions for liquid-spray barrier membranes requires that the prepared substrate and the completed membrane be tested for adequate tensile bond strength in accordance with ASTM D4541, *Standard Test Method for Pull-Off Strength of Coatings Using Portable Adhesion Testers*. At least one test is specified for every 55 yd<sup>2</sup> of deck area, with a minimum of three tests per structure or deck construction phase. When the bond strength of the substrate is less than 100 psi, the engineer may request additional surface preparation. Illinois has a similar specification and specifies a minimum tensile adhesion value of 100

psi with failure in the concrete. Testing is performed using samples of the membrane before installation of the complete membrane. Testing of the installed membrane is not specified. Illinois requires and New Hampshire may require holiday testing of the liquid membrane in accordance with ASTM D4787, *Standard Practice for Continuity Verification of Liquid or Sheet Linings Applied to Concrete Substrates*.

The New York State DOT special specification for spray-applied waterproofing membranes also requires testing of the substrate after the primer has been applied and after the membrane has been installed. A minimum adhesion of 1 MPa (145 psi) is specified for portland cement concrete decks.

New Jersey requires testing of the adhesion between the primer and the substrate in accordance with ASTM D4541, *Standard Test Method for Pull-Off Strength of Coatings Using Portable Adhesion Testers*, at a frequency of at least three tests for areas less than 5,000 ft<sup>2</sup> and one test for every 3,000 ft<sup>2</sup> for areas more than 5,000 ft<sup>2</sup> and at locations where deficient adhesion is suspected.

#### **Infrared Thermography**

Infrared thermography senses the emission of thermal radiation and produces a visual image from the thermal signal. It has the potential to identify defects in waterproofing membranes because it permits large areas to be surveyed in a short time. Its disadvantage is the requirement for the appropriate environmental conditions to achieve the heat flow conditions to detect the presence of anomalies. Thermography has the ability to detect blisters in waterproofing membranes (28), delaminations in bridge decks (29), and defects after the installation of waterproofing membranes (30).

#### **RECENT RESEARCH**

In 1996 and 1997, the New Hampshire Department of Transportation (NHDOT) evaluated various membrane materials, primers, and application methods to determine the effects of materials and methods on the adhesion strength of commercially available membranes (31). Concrete pads simulating dry and wet substrates as typically encountered on New Hampshire bridge decks were constructed at two locations. The test program included 11 preformed membranes, 5 liquid membranes, and 14 primers in various combinations. The primary method of evaluating the systems was adhesion testing.

The study findings resulted in a change in NHDOT specifications in 1998. The use of standard preformed peel-and-

stick barrier membranes was discontinued and replaced with welded-by-torch and spray-applied liquid membrane systems because of the latter's higher adhesion strengths. According to the survey for this synthesis, NHDOT has used heat-applied barrier membranes on essentially every bridge deck since 2000. Although spray-applied barrier membranes are still permitted, contractors provide the heat-applied systems because of their lower initial cost. Various installation methods were also studied, with the following conclusions:

- Air blast versus abrasive blast surface preparation showed no effect on bond.
- Rolling versus brooming of preformed membranes showed no substantial benefit of either method.

Alaska DOT performed field evaluations of selected bridges to determine whether the waterproofing membrane was bonded to the concrete bridge deck and the asphalt overlay (32). The project was initiated because some of the preformed membranes, generally on high-traffic volume roads, had failed to bond adequately to either the asphalt overlay or the concrete bridge deck. Five proprietary products were included in the evaluation.

Concrete cores were taken from three bridge decks to inspect for bonding. Bonding between the membrane and the concrete or the asphalt overlay was observed in all but one core, although no measurements of bond strength were reported. Separate pull-out tests using similar procedures to ASTM C900, *Standard Test Method for Pullout Strength of Hardened Concrete*, were used to determine the tensile bond strength between the asphalt overlay and the membrane. Based on the reported loads, the bond stresses ranged from 22 to 112 psi, with higher asphalt temperatures giving higher bond strengths.

One recommendation from the research was to require a 4-in. thickness of pavement over the membrane to allow for future pavement surface rehabilitation without damaging the existing membrane (33).

Research about tack coats for use with asphalt is being performed under NCHRP Project 09-40, "Optimization of Tack Coat for HMA Placement." The objectives of this study are to determine optimum application methods, equipment type and calibration procedures, application rates, and asphalt binder materials for the various uses of tack coats and to recommend revisions to relevant AASHTO methods and practices related to tack coats. Bond tests are expected to be recommended.

## CONCLUSIONS AND RESEARCH NEEDS

### CONCLUSIONS

A waterproofing membrane is defined as a thin impermeable membrane that is used in conjunction with a hot-mix asphalt wearing surface to protect the deck concrete from the penetration of moisture and deicing salts. Most Canadian provinces and many European countries require the use of waterproofing membrane on new bridge decks. In contrast, about 60% of the U.S. state agencies use them, with greater usage on existing bridge decks than new bridges.

The number of states and provinces using waterproofing membranes on concrete bridge decks has not changed significantly since *NCHRP Synthesis 220* was published in 1995. Most of the states and provinces that did not use them in 1994 are still not using them today. Reasons these agencies do not use them include the nonuse of deicing salts, poor performance of membranes in the past, the use of alternative deck protection strategies, and the preference for having an exposed concrete deck to observe any deterioration.

The survey identified 23 different proprietary products that have been used in the past 16 years. Most are still available today. The systems can be classified as preformed sheet systems or liquid systems. Preformed sheet systems are often rolled into place and bonded to the concrete deck using a pressure-sensitive adhesive on the sheet or through the use of heat. Liquid systems are applied either hot or cold using spray equipment or by hand using rollers and squeegees. Liquid systems may include a layer of reinforcing fabric. Both systems use a tack coat between the membrane and the asphalt overlay to enhance the bond between the materials.

Waterproofing membranes are not expected to last longer than the asphalt wearing surface, including one resurfacing of the asphalt overlay. To achieve this, the initial asphalt thickness has to be sufficient to allow the top surface to be milled without damaging the membrane. The expected service life of waterproofing membranes is generally 16 to 20 years when installed on new bridge decks and anywhere between 6 and 20 years when installed on existing bridge decks. From the information provided in the survey, it could not be determined whether preformed sheet systems or liquid systems have a longer service life.

Information obtained from the survey and additional contact with several agencies that have used multiple systems revealed little unbiased literature and data about the performance of different systems. Although there were reports about products failing to work properly on individual bridges, there does not appear to be a general consensus across North America about the best materials to use. The Canadian provinces, however, appear to have a preference for using rubberized asphalt membranes.

Waterproofing systems consisting of either constructed-in-place membrane systems or preformed membrane systems are addressed in the *AASHTO LRFD Bridge Construction Specifications*. The individual materials used in both systems are required to conform to various ASTM specifications. State specifications are similar to the AASHTO specifications, with some states providing more details and others providing fewer. Three major differences were noted between the U.S. state and Canadian province specifications:

1. Canadian specifications generally require the use of hot-applied rubberized asphalt, whereas the U.S. specifications permit other types of membranes.
2. Some Canadian specifications required rubber membranes or reinforcing fabric over cracks or joints before applying the membrane.
3. Most Canadian specifications require the use of protection board, whereas U.S. specifications do not.

The survey conducted for this synthesis identified the following findings:

- Agencies have a broad range of criteria for using membranes, ranging from standard practice to temporary fixes.
- The three primary reasons for selecting a particular membrane are track record of previous installations, cost, and desired service life.
- Approximately 50% of the agencies that use waterproofing membranes do not have standard details relating to their installation. In many cases, the installation has to conform to the manufacturer's procedures.
- Approximately 60% of the agencies that use waterproofing membranes on new bridge decks have speci-

cations for the surface preparation. The corresponding number for existing bridge decks is 80%.

- The two major products used in conjunction with waterproofing membranes are primers applied to the concrete deck and tack coats applied to the membrane before placing the protective surface layer of asphalt.
- Although several types of defects have been observed with waterproofing systems, the three predominant ones are lack of adhesion between the waterproofing membrane and the concrete deck, lack of adhesion between the waterproofing membrane and the asphalt surface, and moisture penetration through the membrane. All types of defects were more prominent with membranes applied to existing bridge decks than with membranes applied to new bridge decks.
- Unit costs showed a wide range of values for membranes installed on either new or existing bridge decks.

The literature review found that only a few articles about research and use of waterproofing membranes have been published since *NCHRP Synthesis 220* in 1995. In addition, the methods reported in 1994 to evaluate waterproofing membrane systems in the field still exist today, but no method has emerged as being universally acceptable.

The review of state and provincial specifications identified the following installation practices for waterproofing membranes:

#### 1. Pre-installation

- Require a manufacturer's representative to be present when work is performed.
- Require that all work be performed by the manufacturer's certified personnel.

#### 2. Surface Preparation

- Ensure that the concrete surface is free of protrusions and rough edges.
- Use abrasive blasting to remove all contamination from the deck, including all material from any previous membrane.
- Do not use water to clean the deck.
- Clean surface with brooms, vacuum, or compressed air to remove all loose material before applying the membrane system.
- Reinforce or repair cracks before placing the membrane.

#### 3. Installation of Waterproofing System

- Specify a minimum deck and/or air temperature before applying the membrane.
- Specify a dry deck and application only in dry weather.

- Use a primer to enhance the bond between the concrete deck and the membrane, where required by the specifications or the manufacturer.
- Install reinforcing membrane over cold joints and cracks.
- Make a complete seal with the curb up to the depth of the asphaltic concrete overlay.
- Begin placement of preformed membranes on the low point of the deck and provide adequate lap between adjacent strips.
- Stagger membrane overlaps in the transverse direction.
- Repair any blisters that appear in the membrane before the overlay is placed.
- Prohibit or minimize traffic on the membrane and allow only rubber-tired vehicles until the overlay is placed.
- Specify a minimum and maximum time between membrane application and the first layer of overlay placement.
- Use a tack coat to enhance the bond between the membrane and the overlay.

#### 4. Quality Control

- Conduct adhesion bond testing for spray-applied membranes.
- Perform leak testing after the overlay is placed.

No standard tests exist to evaluate the overall performance of waterproofing membrane systems, no reliable methods exist to assess the quality of the installed systems, and no proven techniques exist to determine any deterioration of the membrane system during its service life. Consequently, it is not surprising that agencies with no experience in installing membranes are reluctant to start using them. On the other hand, agencies with experience believe they provide a reliable bridge deck protection strategy.

Most Canadian provinces and many European and Asian countries that utilize waterproofing membranes believe that they are essential for the protection of bridge decks.

#### FUTURE RESEARCH

The information collected for this synthesis suggests a need to conduct a more in-depth investigation of systems used in the United States and Canada. This investigation would include site visits and meetings with owners who have installed membranes successfully and believe in their use as a deck protection strategy. It could be conducted as a state pooled fund research project by those states interested in enhancing their use of waterproofing membranes.

Standard test methods should also be developed to evaluate the overall performance of proprietary waterproofing

membrane systems, assess the quality of installed systems, and identify deterioration of the membrane system during its service life. Waterproofing membrane systems could then be included in the AASHTO National Transportation Product Evaluation Program.

A TRB Maintenance Research Master Planning Workshop was held in January 2000 to develop a 3-, 5-, and 10-year phased master plan of maintenance research needs (*Transportation Research Circular E-C022* 2000). Before the meeting, the TRB Highway Maintenance Committees prepared 60 research needs problem statements. The end result of the workshop was a series of recommended research projects and synthesis topics. TRB Committee A3C15—Corrosion developed and submitted the following research problem statement to the workshop:

**Performance Specification for Bridge Deck Waterproofing Membrane Systems Problem:** Waterproofing membranes can be an effective method of protecting both the concrete and embedded reinforcement in new and existing bridge decks. Except for a few states, membranes are used only sporadically in the United States, often to provide only a short extension of service life on existing decks. *NCHRP Synthesis Report 220, Waterproofing Membranes for Concrete Bridge Decks*, noted that North American practice has changed little in the past 20 years. The vast majority of membranes installed in the United States are preformed products, and the market is dominated by three products introduced in the 1970s. A 1995 FHWA scanning tour of bridge technology in Europe observed the broad range of materials and widespread use of waterproofing systems in protecting bridge decks in aggressive environments.

The waterproofing membrane is only one component of waterproofing systems that may include primers, adhesives, protection board, tack coat, and bituminous concrete layers. The performance of the system is determined by the complex interaction of material factors, design details, and quality of construction. Research is required to define performance requirements for waterproofing systems, to be followed by development of a suite of quantitative prequalification tests and quality assurance procedures, the findings to be embodied in a performance specification. The specification should cover the material requirements for the membrane, adhesives, and protection board (if used), together with requirements for installation. The performance specification could also include provisions for life-cycle costing so that systems that offer superior performance can compete on an equitable basis with systems that have low initial cost but a short service life.

**Objectives:** Develop a performance specification for bridge deck waterproofing membrane systems based on a quantitative definition of performance requirements, objective prequalification tests, and a life-cycle cost analysis. The objective is to encourage competition between a wide range of products and processes, all of which will perform satisfactorily in the field.

**Cost:** \$350,000.

**Duration:** 36 months.

The statement was not selected by the workshop participants for the master plan. However, based on the information provided in this synthesis, the need for a performance specification for bridge deck waterproofing systems still exists today.

## REFERENCES

### CITED REFERENCES

1. Hida, S., et al., *Assuring Bridge Safety and Serviceability in Europe*, Report FHWA-PL-10-04, Federal Highway Administration, Washington, D.C., 2010, 56 pp.
2. Manning, D.G., *NCHRP Synthesis of Highway Practice 4: Concrete Bridge Durability*, Transportation Research Board, National Research Council, Washington, D.C., 1970, 28 pp.
3. Federal Highway Administration (FHWA), *Federal-Aid Highway Program Manual*, Vol. 6, Chapter 7, Section 2, Subsection 7, Concrete Bridge Decks, Transmittal 188, FHWA, Washington, D.C., Apr. 5, 1976.
4. Manning, D.G., *NCHRP Synthesis of Highway Practice 57: Durability of Concrete Bridge Decks*, Transportation Research Board, National Research Council, Washington, D.C., 1979, 61 pp.
5. Manning, D.G., *Synthesis of Highway Practice 220: Waterproofing Membranes for Concrete Bridge Decks*, Transportation Research Board, National Research Council, Washington, D.C., 1995, 69 pp.
6. Babaie, K. and N.M. Hawkins, *NCHRP Report 297: Evaluation of Bridge Deck Protective Strategies*, Transportation Research Board, National Research Council, Washington, D.C., 1987, 80 pp.
7. Russell, H.G., *NCHRP Synthesis of Highway Practice 333: Concrete Bridge Deck Performance*, Transportation Research Board of the National Academies, Washington, D.C., 2004, 101 pp.
8. Kepler, J.L., D. Darwin, and C.E. Locke, Jr., *Evaluation of Corrosion Protection Methods for Reinforced Concrete Highway Structures*, SM Report No. 58, University of Kansas Center for Research, Inc., Lawrence, 2000, 222 pp.
9. American Association of State Highway and Transportation Officials, (AASHTO), *AASHTO LRFD Bridge Construction Specifications*, 3rd ed., AASHTO, Washington, D.C., 2010.
10. Ontario Provincial Standard Specification, *Construction Specification for Waterproofing Bridge Decks with Hot Applied Asphalt Membrane*, OPSS 914, Ontario, Canada, revised Nov. 2009.
11. United Kingdom Department for Transport (UKDOT), *Design Manual for Roads and Bridges, Volume 2, Highway Structures (Sub Structures and Special Structures), Materials, Section 3 Materials and Components Part 4, BD47/99, Waterproofing and Surfacing of Concrete Bridge Decks*, UKDOT, London, 1999.
12. Bridge Deck Waterproofing Association webpage, Crowthorne, U.K. [Online]. Available: [www.bdwa.org.uk](http://www.bdwa.org.uk).
13. Mertz, D.R., *NCHRP Report 381: Report on the 1995 Scanning Review of European Bridge Structures*, National Research Council, Transportation Research Board, Washington, D.C., 1996, 30 pp.
14. Russell, H.G., *NCHRP Research Results Digest 232: Report on the 1997 Scanning Review of Asian Bridge Structures*, Transportation Research Board, National Research Council, Washington, D.C., Nov. 1998, 45 pp.
15. Hearn, G., et al., *Bridge Preservation and Maintenance in Europe and South Africa*, Report No. FHWA-PL-05-002, Federal Highway Administration, U.S. Department of Transportation, Washington, D.C., Apr. 2005, 150 pp.
16. Ralls, M.L., et al., *Prefabricated Bridge Elements and Systems in Japan and Europe*, FHWA, U.S. Department of Transportation, Report No. FHWA-PL-05-003, Mar. 2005, 64 pp.
17. International Concrete Repair Institute (ICRI), *Guidelines for Selecting and Specifying Concrete Surface Preparation for Sealers, Coatings, and Polymer Overlays*, ICRI, Rosemont, Ill., 1997, 41 pp.
18. Sohanchpurwala, A.A., *NCHRP Report 558: Manual on Service Life of Corrosion-Damaged Reinforced Concrete Bridge Superstructure Elements*, Transportation Research Board of the National Academies, Washington, D.C., 2006, 59 pp.
19. Xi, Y., N. Abu-Hejleh, A. Asiz, and A. Suwito, *Performance Evaluation of Various Corrosion Protection Systems of Bridges in Colorado*, Colorado Department of Transportation, Report No. CDOT-DTD-R-2004-1, Final Report, Jan. 2004, 141 pp.
20. Distlehorst, J., *Cost-Effective Bridge Deck Reconstruction in Kansas Using High-Density Concrete Overlays and Asphalt Overlays*, Report No. FHWA KS-07-4, Kansas Department of Transportation Bureau of Materials and Research, Topeka, Kans., Aug. 2009.
21. Wojakowski, J. and M. Hossain, "Twenty-Five-Year Performance History of Interlayer Membranes on Bridge Decks in Kansas," *Transportation Research Record 1476*, Transportation Research Board, National Research Council, Washington, D.C., 1995, pp 180–187.
22. Hearn, G. and Y. Xi, *Service Life and Cost Comparisons for Four Types of CD Bridge Decks*, Report No. CDOT-2007-2, Final Report, Colorado Department of Transportation, Denver, Sep. 2007, 116 pp.



23. Liang, Y., W. Zhang, and Y. Xi, *Strategic Evaluation of Different Topical Protection Systems for Bridge Decks and the Associated Life-Cycle Cost Analysis*, Report No. CDOT-2010-6, Colorado Department of Transportation, Denver, 2010, 71 pp.
24. Korhonen, C.J., J.S. Buska, E.R. Cortez, and A.R. Grotorex, *Procedures for the Evaluation of Sheet Membrane Waterproofing*, Report NETCR 13, U.S. Army Corps of Engineers Cold Regions Research and Engineering Laboratory, Hanover, N.H., 1999, 67 pp. (Also published as CRREL Special Report 99-11.)
25. European Organisation for Technical Approvals (EOTA), *Determination of the Resistance to the Passage of Chloride Ions through Waterproofing Layer Subjected to Indentation by Aggregate*, European Organisation for Technical Approvals, Report No. TR 022, Nov. 2007, 9 pp.
26. McKeel, W.T., *A Commentary on the Implementation of Virginia Test Method Number 39, Electrical Resistivity Testing of Waterproof Membranes*, Report No. VHTRC 76-R57, Virginia Highway & Transportation Research Council, May 1976, 11 pp., plus appendices.
27. Morey, R.M., *NCHRP Synthesis of Highway Practice 255: Ground Penetrating Radar for Evaluating Subsurface Conditions for Transportation Facilities*, National Research Council, Transportation Research Board, Washington, D.C., 1998, 37 pp.
28. Stimolo, M., "Practical Utilization of Thermography in Road Construction and in Waterproofing Systems," *The International Society for Optical Engineering (SPIE) Proceedings*, Vol. 4710, 2002, pp. 299–306.
29. ACI Committee 228, *Non-destructive Test Methods for Evaluation of Concrete in Structures (ACI 228.2R-98)*, American Concrete Institute, Farmington Hills, Mich., 1998, 59 pp.
30. LCPC, *Non-Destructive Testing in LCPC, An Overview*, Laboratoire Central des Ponts et Chaussées, Paris, Apr. 2008. [Online]. Available: [http://onlinepubs.trb.org/onlinepubs/shrp2/tra\\_2008\\_oa07\\_bis\\_modified.pdf](http://onlinepubs.trb.org/onlinepubs/shrp2/tra_2008_oa07_bis_modified.pdf) [accessed June 8, 2011].
31. Boisvert, D.M., *Evaluation of the Bond between Barrier Membrane and Concrete Bridge Decks*, Draft Report No. FHWA-NH-RD-12323G, New Hampshire Department of Transportation, Concord, 2003, unpublished.
32. Martinelli, P., *Bridge Deck Waterproofing Membrane Evaluation*, Alaska Department of Transportation and Public Facilities, Report No. AK-RD-96-04, Sep. 1996, 69 pp.
33. *Transportation Research Circular E-C-022: Maintenance Research Master Planning Workshop*, Transportation Research Board of the National Academies, Washington, D.C., Nov. 2000 [Online]. Available: <http://onlinepubs.trb.org/onlinepubs/circulars/ec022.pdf> [accessed June 8, 2011].

#### REFERENCED STANDARDS BY ASTM INTERNATIONAL

- C900 Standard Test Method for Pullout Strength of Hardened Concrete
- D5 Standard Test Method for Penetration of Bituminous Materials
- D36/D36M Standard Test Method for Softening Point of Bitumen (Ring-and-Ball Apparatus)
- D41/D41M Standard Specification for Asphalt Primer Used in Roofing, Dampproofing, and Waterproofing
- D146 Standard Test Methods for Sampling and Testing Bitumen-Saturated Felts and Woven Fabrics for Roofing and Waterproofing
- D173 Standard Specification for Bitumen-Saturated Cotton Fabrics Used in Roofing and Waterproofing
- D449 Standard Specification for Asphalt Used in Damp-proofing and Waterproofing
- D517 Standard Specification for Asphalt Plank
- D882 Standard Test Method for Tensile Properties of Thin Plastic Sheeting
- D1228 (Withdrawn Standard) Methods of Testing Asphalt Insulating Siding Surfaced with Mineral Granules (Withdrawn 1982)
- D1668 Standard Specification for Glass Fabrics (Woven and Treated) for Roofing and Waterproofing
- D1777 Standard Test Method for Thickness of Textile Materials
- D3236 Standard Test Method for Apparent Viscosity of Hot Melt Adhesives and Coating Materials
- D3515 (Historical Standard) Standard Specification for Hot-Mixed, Hot-Laid Bituminous Paving Mixtures (D3515 does not appear to be the correct number for this AASHTO specification.)
- D3633 Standard Test Method for Electrical Resistivity of Membrane-Pavement Systems
- D4071 Standard Practice for Use of Portland Cement Concrete Bridge Deck Water Barrier Membrane System
- D4541 Standard Test Method for Pull-Off Strength of Coatings Using Portable Adhesion Testers
- D4632 Standard Test Method for Grab Breaking Load and Elongation of Geotextiles
- D4787 Standard Practice for Continuity Verification of Liquid or Sheet Linings Applied to Concrete Substrates

D6153 Standard Specification for Materials for Bridge Deck Waterproofing Membrane Systems

D6690 Standard Specification for Joint and Crack Sealants, Hot Applied, for Concrete and Asphalt Pavements

E96/E96M Standard Test Methods for Water Vapor Transmission of Materials

E154 Standard Test Method for Water Vapor Retarders Used in Contact with Earth Under Concrete Slabs, on Walls, or as Ground Cover

## APPENDIX A

### Survey Questionnaire

The following survey for this synthesis was mailed in January 2011 to 50 U.S. state highway agencies, the District of Columbia, and 13 provincial and territorial highway agencies in Canada to collect information about the use of waterproofing membranes on concrete bridge decks. A total of 51 responses were received, including 18 from agencies that have not used waterproofing membranes since 1994.

**Synthesis Survey  
Topic 42-07  
Waterproofing Membranes for Concrete Bridge Decks**

#### 1. INTRODUCTION

Dear Bridge Engineer:

The Transportation Research Board (TRB) through its National Cooperative Highway Research Program (NCHRP) is preparing a synthesis on Waterproofing Membranes for Concrete Bridge Decks. This is being done under the sponsorship of the American Association of State Highway and Transportation Officials (AASHTO), in cooperation with the Federal Highway Administration (FHWA).

The objective of this study is to compile and synthesize current practices, recent literature findings, and research-in-progress addressing the subject topic. The results of this study will be distributed through AASHTO, TRB, and FHWA in late 2011.

This survey is being sent to U.S. state departments of transportation and Canadian provincial and territorial transportation agencies. If you are not the appropriate person at your agency to complete the survey, please forward it to the correct person. Please note that each section can be answered by a different person; however, only one person can work on the survey at a time (see questionnaire instructions below).

Your agency's response to the survey is extremely important to this study. If your agency has not installed waterproofing membranes since 1994, there are only two questions to answer. If your agency has installed membranes, there are questions related to design, construction, inspection, maintenance, and research.

Please complete and submit this survey by February 11, 2011. We estimate that it should take no more than 60 minutes to complete. If you have any questions, please do not hesitate to contact our principal investigator Henry Russell at [henry@hgrconcrete.com](mailto:henry@hgrconcrete.com) or 847-998-9137. Supporting materials can be uploaded directly into the questionnaire, or you may e-mail them directly to Henry Russell or provide him with the appropriate links.

Thank you very much for contributing to this synthesis of highway practice.

#### KEY DEFINITION:

FOR THE PURPOSE OF THIS SURVEY, A WATERPROOFING MEMBRANE IS DEFINED AS A THIN IMPERMEABLE LAYER THAT IS USED IN CONJUNCTION WITH A HOT MIX ASPHALT WEARING SURFACE.

Please enter the date (MM/DD/YYYY). \_\_\_\_\_

Please enter your contact information. \_\_\_\_\_

First Name \_\_\_\_\_

Last Name \_\_\_\_\_

Title \_\_\_\_\_

Agency/Organization \_\_\_\_\_

Street Address \_\_\_\_\_

Suite \_\_\_\_\_

City \_\_\_\_\_

State \_\_\_\_\_  
Zip/Postal Code \_\_\_\_\_  
Country \_\_\_\_\_  
E-mail Address \_\_\_\_\_  
Phone Number \_\_\_\_\_  
Fax Number \_\_\_\_\_  
Mobile Phone \_\_\_\_\_  
URL \_\_\_\_\_

**2. USAGE**

1. Has your agency installed waterproofing membranes on concrete bridge decks since 1994?  
 Yes  
 No. Click on Next Page at the bottom and it will take you to the final question and then submit survey.
  
2. How many of these installations were on new concrete bridge decks or existing concrete bridge decks?  
New concrete bridge decks (including  
replacement bridge decks on old beams) \_\_\_\_\_  
Existing concrete bridge decks \_\_\_\_\_
  
3. Does your agency continue to specify the use of waterproofing membranes for new concrete bridge decks?  
 Yes  
 No
  
4. Does your agency continue to specify the use of waterproofing membranes for existing concrete bridge decks?  
 Yes  
 No
  
5. Is your agency's use of waterproofing membranes?  
 Increasing  
 Decreasing  
 About the same

**3. PRODUCTS**

6. Please list the commercial names and company names of waterproofing membrane systems used since 1994. Please indicate if they were used on new bridge decks, existing bridge decks, or both, if any of these were experimental, and how long they lasted. (Note: If the level of detail requested is not available, please attach a link to your agency's approved products list in the box provided in question #7.)

**4. SPECIFICATIONS**

7. Please provide any link(s) to document(s) describing the material and construction specifications for waterproofing membranes used by your agency (e.g., your agency's approved products list).  
\_\_\_\_\_  
\_\_\_\_\_

or upload as a file (up to 1MB per file). Additional files may be uploaded in Question 25 (e.g., you agencies approved products list).

**5. CRITERIA**

8. Does your agency have criteria for when waterproofing membranes are used?

	Yes	No
New Bridge Decks	_____	_____
Existing Bridge Decks	_____	_____

If the answer to either of the above is Yes, please provide the criteria. This information may be submitted in the box below as a written description or link(s) to document(s).

---



---

or upload as a file (up to 1MB per file). Additional files may be uploaded in Question 25.

9. What are the expected service lives in years of the waterproofing membranes that your agency has used?

	<u>0 to 5</u>	<u>6 to 10</u>	<u>11 to 15</u>	<u>16 to 20</u>	<u>21 to 25</u>	<u>&gt; 25</u>
New Bridge Decks	_____	_____	_____	_____	_____	_____
Existing Bridge Decks	_____	_____	_____	_____	_____	_____

10. What is the basis for the answers to the previous question?

---



---

11. Does your agency have specific reasons for selecting a particular membrane system?

- ( ) Yes. Go to Question 12.
- ( ) No. Click on Next Page at the bottom and it will take you to Question 13.

12. Please identify the reasons for selecting a particular membrane system.

- [ ] Cost
- [ ] Speed of installation
- [ ] Staged construction options
- [ ] Surface preparation
- [ ] Track record of previous installations
- [ ] Desired service life
- [ ] Availability
- [ ] Coordination requirements
- [ ] Product support
- [ ] Other

If other, please describe briefly.

---



---

**6. DESIGN DETAILS**

13. Does your agency have standard details for the following:

	Yes	No
Installing waterproofing membranes	_____	_____
Terminating edges of membranes	_____	_____
Curb details for membranes	_____	_____
Concrete barrier details for use with membranes	_____	_____
Over construction joints	_____	_____
At expansion joints	_____	_____

If the answer to any of the above is Yes, please provide the details. This information may be submitted in the box below as a written description or link(s) to document(s).

---



---

or upload as a file (up to 1MB per file). Additional files may be uploaded in Question 25.

14. Does your agency use any of the following products in conjunction with waterproofing membranes?

	Yes	No
Primers applied to the concrete	_____	_____
Venting layers	_____	_____
Separate adhesives to bond the membrane	_____	_____
Seepage layers	_____	_____
Protection board	_____	_____
Tack coat	_____	_____
Other	_____	_____

If the answer to any of the above is Yes, please provide any additional details about the product's use. This information may be submitted in the box below as a written description or link(s) to document(s).

---



---

or upload as a file (up to 1MB per file). Additional files may be uploaded in Question 25.

**7. CONSTRUCTION AND INSPECTION**

15. Does your agency have specifications for the surface preparation of new concrete bridge decks prior to the application of the waterproofing membrane system?

- ( ) Yes
- ( ) No

16. Does your agency have specifications for the surface preparation of existing concrete bridge decks prior to the application of the waterproofing membrane system?

- ( ) Yes
- ( ) No

17. Does your agency have special inspection practices during installation of waterproofing membrane systems?

( ) Yes

( ) No

If any answer to Questions 15, 16, or 17 is Yes, please provide the specifications or practices. This information may be submitted in the box below as a written description or link(s) to document(s).

---



---

or upload as a file (up to 1MB per file). Additional files may be uploaded in Question 25.

**8. COSTS**

18. If available, please provide the unit cost (labor, equipment, and materials) for the waterproofing membrane system only for each project during the past five years. Please list as many as possible.

	Project Name	Unit Cost, \$/sq ft	New or Existing Deck
1			
2			
3			
4			
5			
6			
7			
8			
9			
10			

**9. PERFORMANCE**

19. What defects has your agency observed in the performance of waterproofing membranes on new concrete bridge decks?

	Yes	No
Lack of adhesion between the waterproofing membrane and the concrete deck	_____	_____
Lack of adhesion between the waterproofing membrane and the asphalt surface	_____	_____
Punctured waterproofing membranes	_____	_____
Membrane blistering	_____	_____
Horizontal shear failure at the membrane	_____	_____
Cracks in the waterproofing membrane	_____	_____
Voids under the waterproofing membrane	_____	_____
Reinforcement corrosion	_____	_____
Moisture penetration through the membrane but cause unknown	_____	_____
Other	_____	_____

If Other, please describe briefly.

---



---

20. What defects has your agency observed in the performance of waterproofing membranes on existing concrete bridge decks?

	Yes	No
Lack of adhesion between the waterproofing membrane and the concrete deck	_____	_____
Lack of adhesion between the waterproofing membrane and the asphalt surface	_____	_____
Punctured waterproofing membranes	_____	_____
Membrane blistering	_____	_____
Horizontal shear failure at the membrane	_____	_____
Cracks in the waterproofing membrane	_____	_____
Voids under the waterproofing membrane	_____	_____
Reinforcement corrosion	_____	_____
Moisture penetration through the membrane but cause unknown	_____	_____
Other	_____	_____

If Other, please describe briefly.

---



---

**10. REPAIRS**

21. If your agency has requirements or specifications for repair of membrane systems, please provide details. This information may be submitted in the box below as a written description or link(s) to document(s).

---



---

or upload as a file (up to 1MB per file). Additional files may be uploaded in Question 25.

**11. RESEARCH**

22. Has your agency used any non-destructive testing to assess the condition of the in-place waterproofing membranes?

- ( ) Yes
- ( ) No

If Yes, what method was used? This information may be submitted in the box below as a written description or link(s) to document(s).

---



---

or upload as a file (up to 1MB per file). Additional files may be uploaded in Question 25.

Was the method reliable?

- ( ) Yes
- ( ) No



23. Has your agency sponsored field studies or research on the performance of waterproofing membranes?

Yes

No

If reports are available, please supply a reference or source (person or website link) for further information, or a copy of the report. File(s) may be uploaded in Question 25.

---

---

## 12. REASON FOR NON-USE

24. If your agency has not used or has discontinued the use of waterproofing membranes since 1994, please explain why and include details of unsuccessful experiences and reasons, if applicable.

---

---

or upload as a file (up to 1MB per file). Additional files may be uploaded in Question 25.

## 13. UPLOAD FILES

25. This question may be used to upload any additional relevant files not uploaded in previous questions (up to 1 MB per file).

## 14. PRINTOUT

Here are your complete responses to date. You may print this page using 'control p.' If you wish to change responses before submitting the survey, you may do so by paging back.

Thank You!

You have now completed this questionnaire.

We appreciate your assistance.

## APPENDIX B

### Summary of Responses to Survey Questionnaire

#### 1. INTRODUCTION

Responses to the survey were received from the following U.S. highway agencies and Canadian Provinces:

<b>U.S. States</b>	Nevada	Ontario
Alaska	New Hampshire	Prince Edward Island
Arizona	New Jersey	Quebec
Arkansas	New York	Saskatchewan
California	New Mexico	Yukon
Colorado	North Carolina	
Connecticut	North Dakota	
Delaware	Oklahoma	
District of Columbia	Oregon	
Florida	Pennsylvania	
Georgia	South Carolina	
Hawaii	South Dakota	
Idaho	Tennessee	
Illinois	Texas	
Indiana	Utah	
Iowa	Virginia	
Kansas	Washington	
Kentucky	Wisconsin	
Louisiana	Wyoming	
Maryland	<b>Canadian Provinces</b>	
Michigan	Alberta	
Minnesota	Manitoba	
Mississippi	New Brunswick	
Missouri	Newfoundland and Labrador	
Nebraska	Nova Scotia	

Responses to the survey questionnaire are summarized in tables and graphs on the following pages. Some of the responses contain long website addresses. This report is available in PDF format from the NCHRP website. The addresses in the PDF version may be used as direct links or cut and pasted into a web browser.

**2. USAGE**

1. Has your agency installed waterproofing membranes on concrete bridge decks since 1994?  
 Yes: 34 agencies  
 No: 19 agencies
  
2. How many of these installations were on new concrete bridge decks or existing concrete bridge decks?  
 New bridge decks: Answers ranged from 4 to over 500.  
 Existing bridge decks: Answers ranged from 1 to over 500.
  
3. Does your agency continue to specify the use of waterproofing membranes for new concrete bridge decks?  
 Yes: 20 agencies  
 No: 14 agencies
  
4. Does your agency continue to specify the use of waterproofing membranes for existing concrete bridge decks?  
 Yes: 27 agencies  
 No: 7 agencies
  
5. Is your agency’s use of waterproofing membranes?  
 Increasing: 3 agencies  
 Decreasing: 7 agencies  
 About the same: 24 agencies

**3. PRODUCTS**

6. Please list the commercial names and company names of waterproofing membrane systems used since 1994. Please indicate if they were used on new bridge decks, existing bridge decks, or both, if any of these were experimental, and how long they lasted.

The following information was determined from the product names and the manufacturer’s description.

Agency	Preformed		Liquid	
	Self- Adhesive	Heat Applied	Spray	Applied Hot
USA				
AK	X	—	—	—
ID	X*	—	—	—
IL	X	—	X	—
KS	X*	—	—	—
MO	—	—	X	—
NE	X	X	—	—
NJ	X	—	X	—
OK	X*	—	—	—
OR	X	—	X	—
PA	X*	—	—	—
UT	—	—	X	—

*Table continued on p.42*

Table continued from p.41

Agency	Preformed		Liquid	
	Self- Adhesive	Heat Applied	Spray	Applied Hot
WA	X*	—	—	—
Canada				
AB	—	—	—	X
NB	X	X	—	—
NL	—	X	—	X
NS	X	—	X	X
PE	X	X	—	X
QC	—	X	—	—
SK	—	—	—	X
— Product not identified *May also use adhesives.				

#### 4. SPECIFICATIONS

7. Please provide any link(s) to document(s) describing the material and construction specifications for waterproofing membranes used by your agency (e.g., your agency's approved products list).

Respondent	Website Address
Alaska	Qualified Products List (QPL) at <a href="http://www.dot.state.ak.us/stwddes/desmaterials/qpl_intro.shtml">http://www.dot.state.ak.us/stwddes/desmaterials/qpl_intro.shtml</a> 2004 Standard Specifications for Highway Construction <a href="http://www.dot.state.ak.us/stwddes/dcsspecs/resources.shtml#">http://www.dot.state.ak.us/stwddes/dcsspecs/resources.shtml#</a>
California	Deck Seal: <a href="http://www.dot.ca.gov/hq/esc/oe/specifications/SSPs/2006-SSPs/Sec_10/49-59/54-120_E_B11-16-07.doc">http://www.dot.ca.gov/hq/esc/oe/specifications/SSPs/2006-SSPs/Sec_10/49-59/54-120_E_B11-16-07.doc</a> Slurry Leveling Course: <a href="http://www.dot.ca.gov/hq/esc/oe/specifications/SSPs/2006-SSPs/Sec_10/49-59/54-150_E_B05-01-06.doc">http://www.dot.ca.gov/hq/esc/oe/specifications/SSPs/2006-SSPs/Sec_10/49-59/54-150_E_B05-01-06.doc</a>
Colorado	<a href="http://apps.coloradodot.info/apl/SearchRpt.cfm?cid=3&amp;scid=36&amp;bcid=18">http://apps.coloradodot.info/apl/SearchRpt.cfm?cid=3&amp;scid=36&amp;bcid=18</a>
Connecticut	Approved products list at: <a href="http://www.ct.gov/dot/lib/dot/documents/dpublications/816/012004/2004_816_original.pdf">http://www.ct.gov/dot/lib/dot/documents/dpublications/816/012004/2004_816_original.pdf</a> See Division II, Section 7.07 and Division III Section M12.04 for specifications pertaining to Membrane Waterproofing (Woven Glass Fabric)
Illinois	<a href="http://www.dot.il.gov/desenv/spec2007/div500.pdf">http://www.dot.il.gov/desenv/spec2007/div500.pdf</a> . See Section 581.
Michigan	Qualified Products List (section 914.11): <a href="http://www.michigan.gov/documents/MDOT-Material_Source_Guide_Qualified_Products_84764_7.pdf">http://www.michigan.gov/documents/MDOT-Material_Source_Guide_Qualified_Products_84764_7.pdf</a> QPL qualification procedure (Section 914.11): <a href="http://www.michigan.gov/documents/mdot/MDOT_MQAP_Manual_7_Section_F_307114_7.pdf">http://www.michigan.gov/documents/mdot/MDOT_MQAP_Manual_7_Section_F_307114_7.pdf</a> Construction specifications: <a href="http://mdotwas1.mdot.state.mi.us/public/specbook/">http://mdotwas1.mdot.state.mi.us/public/specbook/</a> See subsection 710
Missouri	<a href="http://www.modot.mo.gov/business/consultant_resources/documents/711-BSP-03_Waterproofing_Membrane.doc">http://www.modot.mo.gov/business/consultant_resources/documents/711-BSP-03_Waterproofing_Membrane.doc</a> <a href="http://www.modot.mo.gov/business/materials/pdf/PAL/Hot%20Pour%20Joint%20Material.pdf">http://www.modot.mo.gov/business/materials/pdf/PAL/Hot%20Pour%20Joint%20Material.pdf</a>
New Hampshire	Qualified Products List: <a href="http://www.nh.gov/dot/org/projectdevelopment/materials/research/documents/qpl.pdf">http://www.nh.gov/dot/org/projectdevelopment/materials/research/documents/qpl.pdf</a> . See Section 538 Products. Construction Specifications: <a href="http://www.nh.gov/dot/org/projectdevelopment/highwaydesign/specifications/documents/2010_Spec_Book.pdf">http://www.nh.gov/dot/org/projectdevelopment/highwaydesign/specifications/documents/2010_Spec_Book.pdf</a> . See Section 538.
New York	<a href="https://www.nysdot.gov/portal/pls/portal/MEXIS_APP.EI_EB_DOC_DETAILS.show?p_arg_names=doc_id&amp;p_arg_values=6637">https://www.nysdot.gov/portal/pls/portal/MEXIS_APP.EI_EB_DOC_DETAILS.show?p_arg_names=doc_id&amp;p_arg_values=6637</a> <a href="https://www.nysdot.gov/portal/pls/portal/MEXIS_APP.EI_EB_DOC_DETAILS.show?p_arg_names=doc_id&amp;p_arg_values=6579">https://www.nysdot.gov/portal/pls/portal/MEXIS_APP.EI_EB_DOC_DETAILS.show?p_arg_names=doc_id&amp;p_arg_values=6579</a> <a href="https://www.nysdot.gov/divisions/engineering/technical-services/technical-services-respository/alme/con_wat.html">https://www.nysdot.gov/divisions/engineering/technical-services/technical-services-respository/alme/con_wat.html</a>
Oklahoma	<a href="http://www.okladot.state.ok.us/c_manuals/specbook/oe_ss_2009.pdf">http://www.okladot.state.ok.us/c_manuals/specbook/oe_ss_2009.pdf</a> . Overlays are covered in Section 505 including asphalt membrane overlays. Membrane materials are covered in Section 712.09 (nonwoven).
Oregon	<a href="http://www.oregon.gov/ODOT/HWY/CONSTRUCTION/QPL/Docs/QPL.pdf">http://www.oregon.gov/ODOT/HWY/CONSTRUCTION/QPL/Docs/QPL.pdf</a> <a href="http://www.oregon.gov/ODOT/HWY/SPECS/docs/08book/08_00500.pdf">http://www.oregon.gov/ODOT/HWY/SPECS/docs/08book/08_00500.pdf</a>

Table continued on p.43

Table continued from p.42

Respondent	Website Address
South Carolina	<a href="http://www.scdot.org/doing/standardspecifications/pdfs/2007_full_specbook.pdf">http://www.scdot.org/doing/standardspecifications/pdfs/2007_full_specbook.pdf</a> . Refer to subsection 814 <a href="http://www.scdot.org/doing/constructiondocs/pdfs/materials/070515%20qpp%2010.pdf">http://www.scdot.org/doing/constructiondocs/pdfs/materials/070515%20qpp%2010.pdf</a> for policy <a href="http://www.scdot.org/doing/constructiondocs/pdfs/materials/070515%20QPL%209.pdf">http://www.scdot.org/doing/constructiondocs/pdfs/materials/070515%20QPL%209.pdf</a> for list
Tennessee	<a href="http://www.tdot.state.tn.us/materials/reseval/docs/qualprodlist.pdf">www.tdot.state.tn.us/materials/reseval/docs/qualprodlist.pdf</a> (pp. 42–43; QPL 2, Section A) <a href="http://www.tdot.state.tn.us/construction/specbook/2006_spec600.pdf">www.tdot.state.tn.us/construction/specbook/2006_spec600.pdf</a> (PDF pp. 194–197 or Standard Specifications pp. 521–524)
Utah	<a href="http://www.udot.utah.gov">www.udot.utah.gov</a> . Specification No. 07105 Waterproofing Membrane
Virginia	<a href="http://www.virginiadot.org/business/const/spec-default.asp">www.virginiadot.org/business/const/spec-default.asp</a>
Washington	<a href="http://www.wsdot.wa.gov/Design/ProjectDev/GSPAamendments.htm">http://www.wsdot.wa.gov/Design/ProjectDev/GSPAamendments.htm</a> Material General Special Provision (GSP) 6-08.2(9-11.2).OPT1.GB6
Wyoming	See SS-500C at <a href="http://www.dot.state.wy.us/wydot/engineering_technical_programs/manuals_publications/standard_specifications/2003_supplemental_specifications">http://www.dot.state.wy.us/wydot/engineering_technical_programs/manuals_publications/standard_specifications/2003_supplemental_specifications</a>
Alberta	Construction Specifications: <a href="http://www.transportation.alberta.ca/Content/docType246/Production/07bcs16.pdf">www.transportation.alberta.ca/Content/docType246/Production/07bcs16.pdf</a> Drawing: <a href="http://www.transportation.alberta.ca/Content/doctype30/production/S1443-98-rev7.pdf">http://www.transportation.alberta.ca/Content/doctype30/production/S1443-98-rev7.pdf</a>
Manitoba	Standard Construction Specifications: <a href="http://www.gov.mb.ca/mit/contracts/manual.html">http://www.gov.mb.ca/mit/contracts/manual.html</a> (currently being updated) Approved Products List: <a href="http://www.gov.mb.ca/mit/mateng/index.html">http://www.gov.mb.ca/mit/mateng/index.html</a>
New Brunswick	2006 Standard Specifications: <a href="http://www.gnb.ca/0113/tenders/2006-Specs-e.asp">http://www.gnb.ca/0113/tenders/2006-Specs-e.asp</a> Summary of revisions in 2011: <a href="http://www.gnb.ca/0113/publications/2011_Summary_of_Revisions-e.pdf">http://www.gnb.ca/0113/publications/2011_Summary_of_Revisions-e.pdf</a>
Newfoundland and Labrador	<a href="http://www.iko.com/shared/commercial/chapters/7930001cMfAbridge45.pdf">http://www.iko.com/shared/commercial/chapters/7930001cMfAbridge45.pdf</a> <a href="http://www.soprema.ca/en/content/113/anti-rock-membranes.aspx">http://www.soprema.ca/en/content/113/anti-rock-membranes.aspx</a>
Nova Scotia	<a href="http://gov.ns.ca/tran/publications/standard.pdf">http://gov.ns.ca/tran/publications/standard.pdf</a> Division 5 Section 9
Ontario	Waterproofing membrane: <a href="http://www.roadauthority.com/mpl/mplListVersion.asp?MPICatId=7917BE45-79CB-4CB5-86BD-0CE9204B7EA0">http://www.roadauthority.com/mpl/mplListVersion.asp?MPICatId=7917BE45-79CB-4CB5-86BD-0CE9204B7EA0</a> Protection board: <a href="http://www.roadauthority.com/mpl/mplListVersion.asp?MPICatId=49C888F0-499F-48ED-9DA2-C9120CFF6063">http://www.roadauthority.com/mpl/mplListVersion.asp?MPICatId=49C888F0-499F-48ED-9DA2-C9120CFF6063</a>

## 5. CRITERIA

8. Does your agency have criteria for when waterproofing membranes are used?

	<u>Yes</u>	<u>No</u>
New Bridge Decks	17	15
Existing Bridge Decks	20	13

If the answer to either of the above is Yes, please provide the criteria.

Respondent	New Bridge Decks	Existing Bridge Decks	Criteria
Alaska	Yes	Yes	If an asphalt overlay is used, a waterproofing membrane is specified where possible.
California	Yes	Yes	In freeze-thaw areas only under the following circumstances: Used on sidehill viaducts. Used to avoid a drastic profile change when there is a thick AC overlay on an existing bridge deck that requires replacement.
Connecticut	Yes	Yes	Most bridges in Connecticut are constructed with membranes and bituminous concrete overlays.
Idaho	Yes	Yes	Depends upon what we are trying to achieve.
Illinois	No	Yes	Not allowed anymore on interstate bridge unless replacing in-kind, not to be used on bridges with ADTs over 10,000.
Kansas	No	Yes	We don't use membranes on new decks and I don't think we are going to do so anytime soon. When we have a bridge that has a bad deck that should either be re-decked or the entire bridge replaced and no available funds are currently available, we consider placing a waterproofing membrane with a 2-in. thick asphalt wearing surface as cover to maintain rideability. Of the 30 we have placed since 1994, 25 are currently in place and the other 5 were on bridges that have since been replaced or re-decked.

Table continued on p.44

Table continued from p.43

Respondent	New Bridge Decks	Existing Bridge Decks	Criteria
Michigan	No	Yes	When deck surface has more than 10% deficiencies and deck underside has more than 10% deficiencies and we need to extend the life of the deck by no more than 10 years. See the Deck Preservation Matrix for more detail at <a href="http://www.michigan.gov/documents/mdot/MDOT_BridgeDeckMatrix_182438_7.pdf">http://www.michigan.gov/documents/mdot/MDOT_BridgeDeckMatrix_182438_7.pdf</a> Spec Book <a href="http://mdotwas1.mdot.state.mi.us/public/specbook/">http://mdotwas1.mdot.state.mi.us/public/specbook/</a> pg 461.
Missouri	Yes	No	Waterproofing membranes are currently used only for new construction using adjacent box beams or cored slabs that utilize an asphalt wearing surface. These bridges are constructed on roads with ADT < 1,000. MoDOT has increased its use of this structure type since 2009 as part of an initiative to improve rural bridges, many of which have ADT < 1,000. As such, MoDOT does not have a long track record with membranes. MoDOT has not constructed membranes on concrete bridge decks since the 1994 cutoff date for this survey.
Nebraska		Yes	Used on deteriorated decks with NBIS condition $\geq 5$ when the chloride content is minimum and asphalt overlay is practical.
New Hampshire	No	No	We use them as standard practice.
Oregon	Yes	Yes	<a href="http://www.oregon.gov/ODOT/HWY/BRIDGE/docs/BDDM/apr-2010_finals/section_1-2004_apr10.pdf">http://www.oregon.gov/ODOT/HWY/BRIDGE/docs/BDDM/apr-2010_finals/section_1-2004_apr10.pdf</a>
Pennsylvania	No	Yes	Pub. 15 M Design Manual 4 - Part A Section 5.5.2 pg A.5-25 and 5.6 pg A.5-60 Link = <a href="ftp://ftp.dot.state.pa.us/public/PubsForms/Publications/PUB%2015M.pdf">ftp://ftp.dot.state.pa.us/public/PubsForms/Publications/PUB%2015M.pdf</a>
South Carolina	Yes	No	Waterproofing membranes for cored slab spans.
South Dakota	Yes	Yes	Waterproofing membranes are typically not used on new bridge decks. There was a pair of decks on the interstate where subsurface soils were causing approach roadway rideability problems. In that case, an asphalt overlay was placed on the new bridge decks to provide options for future profile adjustments to maintain a smooth ride. Waterproofing membranes with asphalt overlays are typically used on bridges/decks nearing the end of their service life. The asphalt overlay in that case serves as a good riding wearing course and provides some additional load distribution and buffering to the deteriorated concrete slab underneath. In these cases, the bridge/deck is expected to be replaced in 10 to 15 years following the overlay.
Tennessee	No	Yes	All resurfacing projects where bridge deck repairs are needed as a cost-effective way of waterproofing the repaired bridge deck.
Utah	No	Yes	Waterproofing membranes are standard practice when applying asphalt wearing surfaces on any existing deck. The combination of membrane and asphalt overlay usually occurs when a deck requires pothole patching.
Virginia	Yes	Yes	Asphalt overlay is to be placed on the deck.
Washington	Yes	Yes	All existing structures with asphalt and in the rare cases where asphalt is specified for new structures.
Alberta	Yes	Yes	1. All new bridges with cast-in-place decks. Section 17 "Deck Protection and Wearing Surface" of the Bridge Structure Design Criteria. 2. For all existing bridge decks when additional dead load imposed can be accommodated.
New Brunswick	Yes	Yes	All concrete decks are to be protected by a waterproofing system.
Newfoundland and Labrador	Yes	No	Used on all new and full slab replacement projects.
Ontario	Yes	Yes	Waterproofing membranes are used on all new and existing decks, as a standard policy. Membranes on existing decks are removed and replaced periodically to maintain deck protection.
Prince Edward Island	Yes	No	All new decks shall be waterproofed unless load restrictions prohibit additional asphalt dead load on existing bridges with new decks.

9. What are the expected service lives in years of the waterproofing membranes that your agency has used?

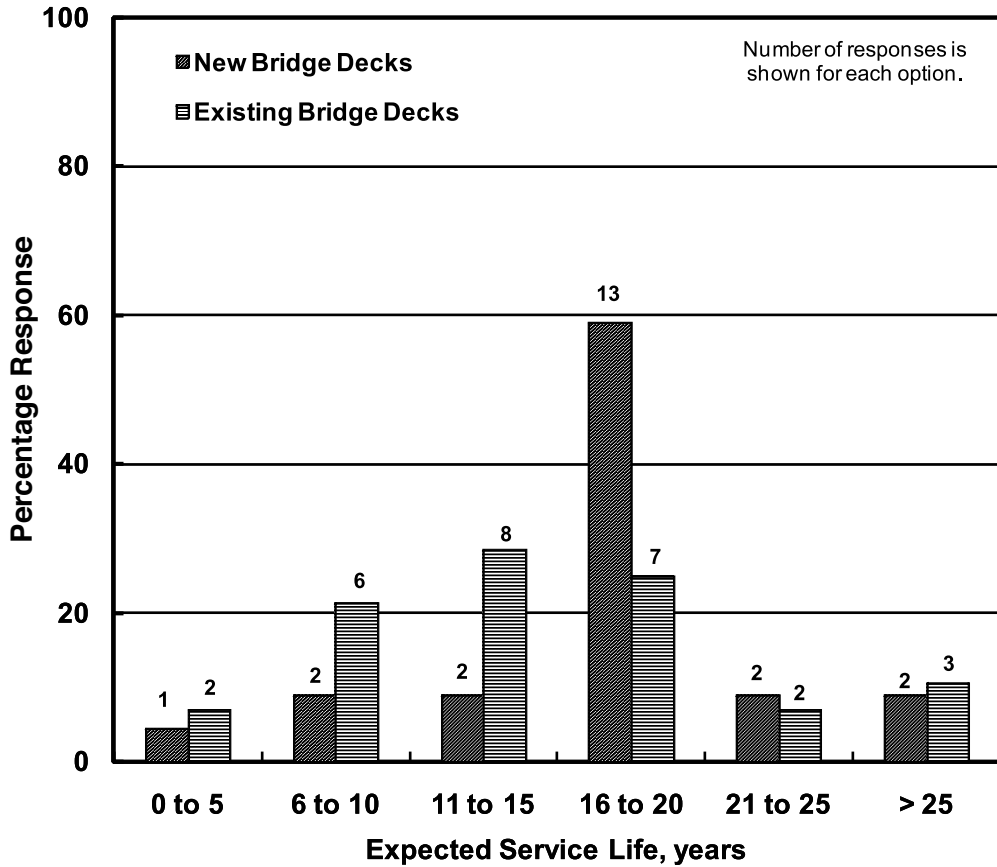

10. What is the basis for the answers to the previous question?

Respondent	New Bridge Decks	Existing Bridge Decks	Basis
Alaska	16 to 20	11 to 15	If properly installed, asphalt deterioration typically governs membrane service life, 10–15 years. On new bridges, a 4-in.-thick overlay is typically used and may extend the service life, whereas on existing bridges less than 4-in. thick may be provided depending on the load rating, which may reduce the service life. Further, existing bridges may have deck damage that may also reduce the expected service life.
California	6 to 10	6 to 10	Expected life of an AC overlay in a freeze-thaw area.
Connecticut	16 to 20	16 to 20	The membrane will typically last approximately two paving cycles of about 10 years each on heavily travelled roadways. A partial depth milling, leaving the membrane intact and repaving is done at the end of the first overlay cycle. The membrane and overlay are typically removed and replaced in whole at the end of the second paving cycle.
Idaho	6 to 15	6 to 15	Experience.
Illinois	11 to 15	11 to 15	Past experience. The membrane only lasts as long as the bituminous wearing surface on top of it.
Kansas		0 to 5	Past performance and the condition of the existing deck that we are covering. We have only used waterproofing membranes as a last resort. They provide extended rideability for a deck that is in very bad shape. Usually in these situations, some full depth patches have to be completed before placement to prevent holes from developing. The plan is usually to extend the deck life for one to four years until funds become available for either a deck or bridge replacement. We have seen them perform for as long as 10 years. When one goes bad, the deteriorated condition of the covered concrete can accelerate. They trap water as well as they stop it when falling.
Michigan		6 to 10	The Deck Preservation Matrix referenced in the answer to Question 8. The expected service life varies based on the initial deck condition. Experience.
Missouri	16 to 20		It is anticipated the membrane will last as long as the asphalt it is beneath.

Table continued on p.46

Table continued from p.45

Respondent	New Bridge Decks	Existing Bridge Decks	Basis
Nebraska		11 to 15	We use asphalt overlay when the life of the deck is near its end and we need to extend the life of the deck by 10 to 15 years before redecking the bridge or major deck rehabilitation with structural overlay such as silica fume. Asphalt life is about 10 to 15 years. So we expect the life of the membrane to exceed the life of the asphalt. Our experience tells us it's hard to replace the asphalt overlay without damaging the membrane.
New Hampshire	11 to 15	11 to 15	This is an estimation, as we do not have any with 15 years of service life yet. The basis (optimism) for this answer is that we frequently had good luck with peel-and-stick, although some of those debonded. The bond with the torch applied is superior, since the liquid asphalt is worked into the concrete surface.
New Mexico	0 to 5	0 to 5	From talking with the districts that have used them. Their experience has been that they do not work well.
New York			Depends on the condition of the existing deck and the overlay placed. Membranes will last as long as both are performing.
Oklahoma	16 to 20	6 to 10	Approximations based on visual observation.
Oregon	16 to 20	16 to 20	We have no basis except anecdotal observations. The range given is about the longest we have seen them be effective. We have seen a few that have been improperly installed that are not effective for even a couple of years. We now require a performance test after installation to show they are at least effective immediately after construction.
Pennsylvania		> 25	Research report that an estimated life is 40 years or more.
South Dakota	16 to 20	11 to 15	Experience.
Tennessee		6 to 10	Life expectancy of asphalt.
Texas		11 to 15	The surface treatments are applied when the deck has lost its skid numbers. Also, surface treatments are applied to bridge decks when the approach roadways are being surface treated and asphalt overlaid.
Utah	6 to 10	6 to 10	Our membranes usually only last about the life of the asphalt applied, which is on average 8-10 years. We applied a few spray-applied waterproofing membranes in 2007-2008 on a trial basis. These products have warranties for the life of the bridge, but we are too early in the evaluation to make a judgment on their performance and durability.
Virginia	16 to 20	16 to 20	The asphalt surface mix will last approximately 10 years and the base mix will last at least 20 years. Resurfacing at 10 years without damaging the membrane gives a 20 year life. The membrane can last 20 to 30 years so a life > 25 years is possible, but I would use 20 years for design and LCC analysis unless we have better data to indicate a longer life.
Washington	21 to 25	21 to 25	Performance of membranes has yet to be proven. WSDOT assumes a reasonable performance through one paving cycle of 20 to 25 years. WSDOT also has a method of data collection to measure the performance of membrane systems, but the results will not be available for many years.
Wyoming		11 to 15	Experience, typical life for an overlay on a bridge deck.
Alberta	> 25	> 25	Waterproofing membrane has been used by Alberta Transportation for over 25 years with very good performance.
Manitoba	16 to 20	16 to 20	Expected service lives are based on the anticipated life expectancy and effectiveness of the waterproofing membrane. MIT is beginning to move away from waterproofing membranes and asphalt overlay systems to exposed concrete decks on our bridges due to deck performance enhancements realized by using fibre-reinforced concrete. Ancillary benefits are reduced dead load and/or increased structural capacity of the deck and better long-term performance of the riding surface (less rutting in wheel paths and potholes at joints).
New Brunswick	21 to 25	21 to 25	Deck surface partially milled and resurfaced at 12-15 years, but membrane and full-depth resurfacing not expected to be replaced until 20-25 years; built in to our asset management system.
Newfoundland and Labrador	16 to 20	16 to 20	Ideally this would be the life of the asphalt pavement. Have in past year started to use greater asphalt thickness on decks. This might allow for rehabilitation of asphalt surface without damaging waterproofing system.
Nova Scotia	16 to 20	11 to 15	Experience has shown these products tend to last in our climate with our traffic loadings.
Ontario	> 25	> 25	An internal study was carried out, examining decks up to 17 years old, which confirmed the effective functioning of the membranes and resulted in an estimated service life of more than 25 years. We have done chloride tests to verify performance after 15-20 years. End result specification would ensure consistent quality of waterproofing.
Prince Edward Island	16 to 20	6 to 10	Experience.
Quebec	16 to 20	16 to 20	Experience.
Saskatchewan	16 to 20	16 to 20	Historically removed waterproofing that was 17 to 20 years old that was in good condition.



11. Does your agency have specific reasons for selecting a particular membrane system

Yes: 22 agencies

No: 9 agencies

12. Please identify the reasons for selecting a particular membrane system.

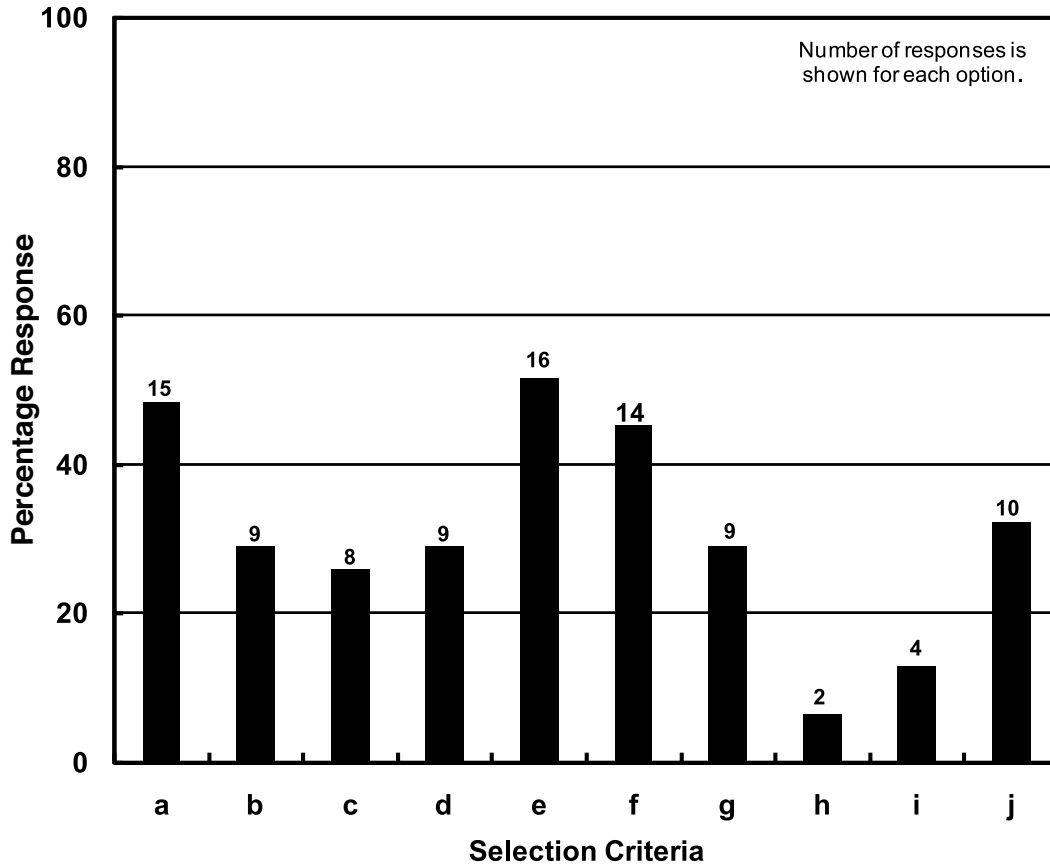

- a. Cost
- b. Speed of installation
- c. Staged construction options
- d. Surface preparation
- e. Track record of previous installations
- f. Desired service life
- g. Availability
- h. Coordination requirements
- i. Product support
- j. Other

If other, please describe briefly.

Other reasons given were as follows:

- Waterproofing membranes that were observed to have a significantly reduced service life were eliminated from use. Waterproofing membranes that were observed to have a significantly longer service life were permitted for use on more projects. Ease of installation and speed of installation were also criteria given our short construction season, but were of less concern than service life and proven installations.
- They provide extended rideability for a deck that is in very bad shape.
- We have spray applied and sheet applied systems. The sprays applied are more expensive and tend to be better performing in difficult or high risk decks; i.e., with environmental concerns.
- Compatibility with asphalt temperatures.

- Familiarity with product components.
- Contractor selects from the QPL.
- The contractor typically requests approval to use one of the approved membranes.
- Selection depends on where the bridge is located and safety/traffic concerns in replacing or repairing the waterproofing system.
- We have considered alternative systems and used them occasionally for unusual applications or on a trial basis, but the hot applied waterproofing membrane system has remained the most cost-effective for general use.
- Very easy to put in place with machines and well-performing membranes.

**6. DESIGN DETAILS**

13. Does your agency have standard details for the following:

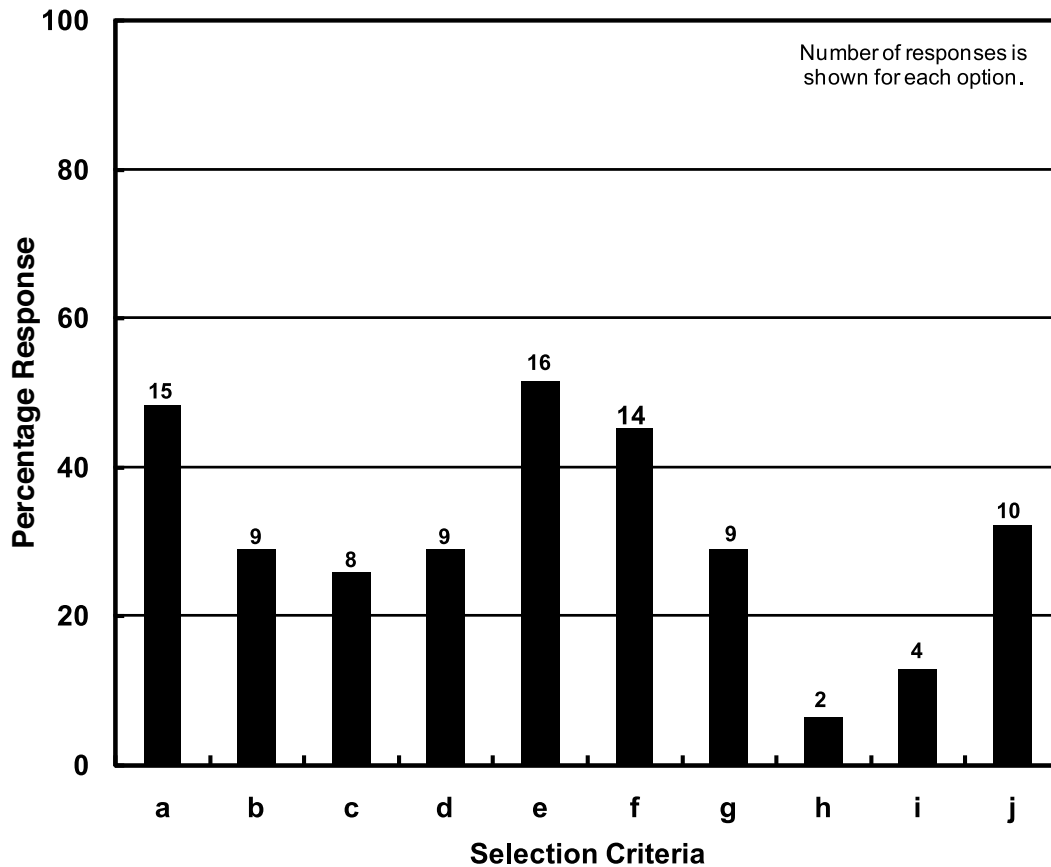

- a. Installing waterproofing membranes
- b. Terminating edges of membranes
- c. Curb details for membranes
- d. Concrete barrier details for use with membranes
- e. Over construction joints
- f. At expansion joints

If the answer to any of the above is Yes, please provide the details.

Respondent	Detail
Alaska	Our standard details are per the manufacturer’s recommendations.
Connecticut	While we have no standard details, requirements for application, limits, and methodology are stipulated in great detail in the item specification for Membrane Waterproofing (woven glass fabric).
Kansas	In general, we request the contractor to provide and follow the manufacturer’s specifications. For expansion joints, we generally install a plug joint type of expansion joint. This joint requires at least 2 in. of asphalt cover to work. These joints seem to perform about as long as needed to match the membrane. We have details (generally bridge-specific) and specifications.
Michigan	Spec Book— <a href="http://mdotwas1.mdot.state.mi.us/public/specbook/">http://mdotwas1.mdot.state.mi.us/public/specbook/</a> p. 461.
New Hampshire	NH does not truly have standard details.
New York	The Manufacturers Materials Details (approved list) offer details to address these conditions.
Oregon	<a href="http://oregon.gov/ODOT/HWY/BRIDGE/Docs/BDDM/apr-2010_finals/section_1-2004_apr10.pdf">http://oregon.gov/ODOT/HWY/BRIDGE/Docs/BDDM/apr-2010_finals/section_1-2004_apr10.pdf</a> see page 1-262.
Pennsylvania	Use the manufacturer’s details. See BC—788M Sheet 11 <a href="ftp://ftp.dot.state.pa.us/Bridge%20Standards/Current%20Bridge%20Construction%20Standards/bc788m_all.pdf">ftp://ftp.dot.state.pa.us/Bridge%20Standards/Current%20Bridge%20Construction%20Standards/bc788m_all.pdf</a>
Tennessee	Mastic is to be applied at terminating edges, curbs, and concrete barriers. An extra layer of membrane is placed over small expansion joints (not strip seals or modular joints) prior to the main membrane application.
Washington	Most suppliers have readily available details.
Alberta	Section 16 “Bridge Deck Waterproofing” of the Specifications for Bridge Construction and Standard Drawing S-1443.
Manitoba	See Specifications for Bridge Construction, Section 16, Standard Drawing S-1443.
New Brunswick	2006 Standard Specifications— <a href="http://www.gnb.ca/0113/tenders/2006-Specs-e.asp">http://www.gnb.ca/0113/tenders/2006-Specs-e.asp</a>
Nova Scotia	<a href="http://gov.ns.ca/tran/publications/standard.pdf">http://gov.ns.ca/tran/publications/standard.pdf</a> Division 5 Section 9

14. Does your agency use any of the following products in conjunction with waterproofing membranes?

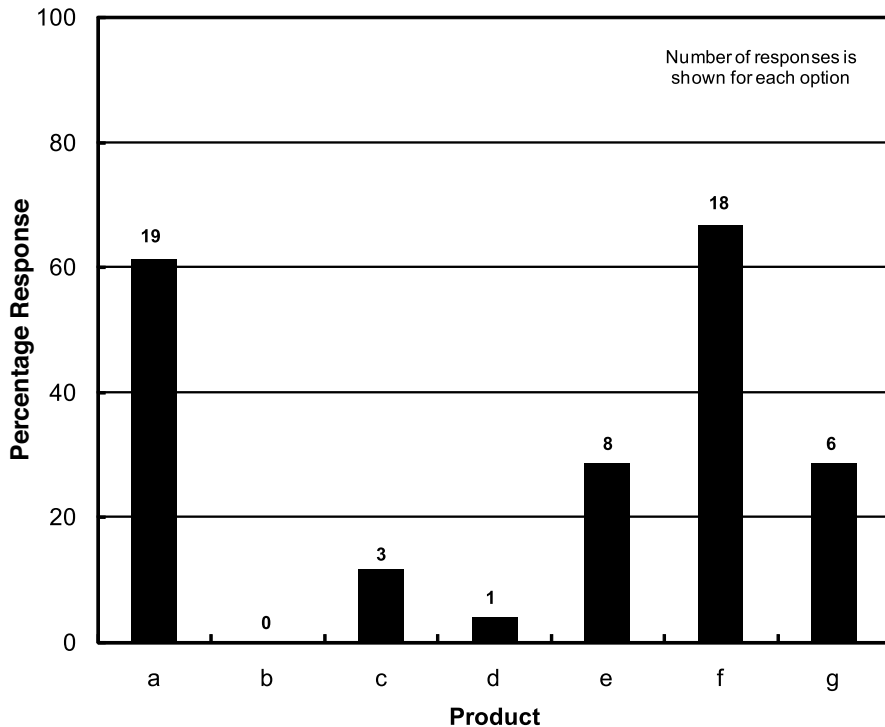

- a. Primers applied to the concrete
- b. Venting layers
- c. Separate adhesives to bond the membrane
- d. Seepage layers
- e. Protection board
- f. Tack coat
- g. Other

If the answer to any of the above is Yes, please provide any additional details about the product’s use.

Respondent	Detail
Alaska	Use of tack coat prior to waterproofing membrane installation is per most manufacturers' recommendations.
California	Install bleeder pipes on low side of deck spaced at 30-ft intervals. See specification.
Connecticut	Primer must meet requirements of ASTM D41 in accordance with the specification.
Idaho	Allow peel and stick
Missouri	The tack coat is used in conjunction with the asphalt wearing surface per MoDOT Standard Specifications.
New Hampshire	See the standard specification, 538.3.2.3.3 for discussion of protection board.
New York	See installation procedures covered in each manufacturer's materials details (approved list).
Pennsylvania	Primers are part of the manufacturer's requirements
South Dakota	See response to Question 7.
Tennessee	Some products on the QPL require tack coat prior to the installation of the membrane.
Utah	Pre-formed roll-on membranes typically have a tack coat that holds the membrane to the deck for ease of installation and paving.
Virginia	The membrane is installed in accordance with VDOT specifications and manufacturer's recommendations. Primers, adhesives, and tack coats are sometimes used if recommended by the manufacturer. Liquid membranes are typically epoxy and broadcast aggregate.
Washington	If a manufacturer recommends a primer, the contractor is required to use it.
Wyoming	Based on manufacturer's recommendations with their supplied membrane.
Alberta	Wick drains and membrane reinforcing fabric. The requirements for these products are described in the applicable specifications and on the standard drawings.
Manitoba	10-mm protection board with 25-mm overlaps (longitudinally and transversely) installed between the waterproofing membrane and asphalt overlay. Protection board to be half sheet staggered (minimum 150 mm) at longitudinal joints in the wearing surface.
New Brunswick	Follow applicable manufacturer's recommendations
Newfoundland and Labrador	Primers as per the membrane manufacture's requirements for SBS modified thermo fusible membrane systems. Protection board is used with some systems.
Nova Scotia	<a href="http://gov.ns.ca/tran/publications/standard.pdf">http://gov.ns.ca/tran/publications/standard.pdf</a> Division 5 Section 9
Ontario	We use tack coat and protection board as part of our standard treatment. We may specify the use of a reinforcing membrane over deck cracks, where these are a significant issue, to help maintain continuity of the membrane.
Prince Edward Island	Primers can be used for peel and stick and hot applied rubberized compound applications. We've used protection boards with the hot applied method and we have allowed for deck drainage between layers of the membrane and asphaltic concrete overlay.
Saskatchewan	Tack coat and protection board used for hot applied rubber membranes is our normal practice.

## 7. CONSTRUCTION AND INSPECTION

15. Does your agency have specifications for the surface preparation of new concrete bridge decks prior to the application of the waterproofing membrane system?
- Yes: 19 agencies  
No: 12 agencies
16. Does your agency have specifications for the surface preparation of existing concrete bridge decks prior to the application of the waterproofing membrane system?
- Yes: 26 agencies  
No: 6 agencies
17. Does your agency have special inspection practices during installation of waterproofing membrane systems?
- Yes: 13 agencies  
No: 19 agencies

If any answer to Questions 15, 16, or 17 is Yes, please provide the specifications or practices.

Respondent	Details
Alaska	2004 Standard Specification for Highway Construction, Section 508 <a href="http://www.dot.state.ak.us/stwddes/dcsspecs/resources.shtml#">http://www.dot.state.ak.us/stwddes/dcsspecs/resources.shtml#</a>
California	Deck Seal <a href="http://www.dot.ca.gov/hq/esc/oe/specifications/SSPs/2006-SSPs/Sec_10/49-59/54-120_E_B11-16-07.doc">http://www.dot.ca.gov/hq/esc/oe/specifications/SSPs/2006-SSPs/Sec_10/49-59/54-120_E_B11-16-07.doc</a> Slurry Leveling Course <a href="http://www.dot.ca.gov/hq/esc/oe/specifications/SSPs/2006-SSPs/Sec_10/49-59/54-150_E_B05-01-06.doc">http://www.dot.ca.gov/hq/esc/oe/specifications/SSPs/2006-SSPs/Sec_10/49-59/54-150_E_B05-01-06.doc</a> file_413279_148681034_2_e_b05-01-06.doc
Connecticut	See requirements specified under "Construction Methods" for Membrane Waterproofing (woven glass fabric) in Form 816. Use following web address to access Form 816: My Documentssurvey <a href="http://www.ct.gov/dot/lib/dot/documents/dpublications/816/012004/2004_816_original.pdf">http://www.ct.gov/dot/lib/dot/documents/dpublications/816/012004/2004_816_original.pdf</a>
Idaho	Basically must be clean. When engineer requires it: ASTM D3633
Illinois	See Section 581 of the Standard Specifications for Roads and Bridges
Kansas	We just use our general concrete patching specification and the contractor must submit and follow the manufacturer's specifications and recommendations for the material they will be using.
Michigan	<a href="http://mdotwas1.mdot.state.mi.us/public/specbook/files/710%20Wtrpr,%20Protective%20Covers.pdf">http://mdotwas1.mdot.state.mi.us/public/specbook/files/710%20Wtrpr,%20Protective%20Covers.pdf</a> See subsection 710.03.C
Michigan	Spec Book <a href="http://mdotwas1.mdot.state.mi.us/public/specbook/">http://mdotwas1.mdot.state.mi.us/public/specbook/</a> p. 461
Missouri	<a href="http://www.modot.mo.gov/business/consultant_resources/documents/711-BSP-03_Waterproofing_Membrane.doc">http://www.modot.mo.gov/business/consultant_resources/documents/711-BSP-03_Waterproofing_Membrane.doc</a>
Nebraska	We require manufacturer's representative and follow their recommendations
New Hampshire	See specification.
New Jersey	As per recommendation of manufacturer's representative.
New York	Our Engineering Instructions, issued with the specifications for each system type, offer guidance and the materials details of each approved system also addresses this.
Oklahoma	Refer to Subsection 505.04C.(1) of our standard specifications <a href="http://www.okladot.state.ok.us/c_manuals/specbook/2009specbook.pdf">http://www.okladot.state.ok.us/c_manuals/specbook/2009specbook.pdf</a>
Oregon	<a href="http://www.oregon.gov/ODOT/HWY/SPECS/2008_special_provisions.shtml">http://www.oregon.gov/ODOT/HWY/SPECS/2008_special_provisions.shtml</a> Part_00500
Pennsylvania	Pub 408 Section 680 Link = <a href="ftp://ftp.dot.state.pa.us/public/bureaus/design/pub408/pub%20408-2011.pdf">ftp://ftp.dot.state.pa.us/public/bureaus/design/pub408/pub%20408-2011.pdf</a>
South Dakota	See response to Question 7.
Utah	Surface preparations are the same for new decks as for existing and are covered in the our standard specification—07105 Waterproofing Membrane
Virginia	Section 416 of the Road and Bridge Specification covers these issues. The surface is typically cleaned and textured by grit blast. VDOT currently inspects most work.
Washington	Contractors are encouraged to use other methods to remove HMA. If rotary milling is used, 1/4-in. tooth spacing is required. Questions 15 & 16: <a href="http://www.wsdot.wa.gov/publications/fulltext/projectdev/gspspdf/5-04.3.OPT3.BSP.GB5.PDF">http://www.wsdot.wa.gov/publications/fulltext/projectdev/gspspdf/5-04.3.OPT3.BSP.GB5.PDF</a> <a href="http://www.wsdot.wa.gov/publications/fulltext/projectdev/gspspdf/6-08.3(2).OPT1.GB6.PDF">http://www.wsdot.wa.gov/publications/fulltext/projectdev/gspspdf/6-08.3(2).OPT1.GB6.PDF</a> <a href="http://www.wsdot.wa.gov/publications/fulltext/projectdev/gspspdf/6-08.3(4).OPT1.GB6.PDF">http://www.wsdot.wa.gov/publications/fulltext/projectdev/gspspdf/6-08.3(4).OPT1.GB6.PDF</a> 16. Measuring asphalt depth: <a href="http://www.wsdot.wa.gov/publications/fulltext/projectdev/gspspdf/5-04.3.OPT2.BSP.FB5.PDF">http://www.wsdot.wa.gov/publications/fulltext/projectdev/gspspdf/5-04.3.OPT2.BSP.FB5.PDF</a> 17. <a href="http://www.wsdot.wa.gov/publications/fulltext/projectdev/gspspdf/6-08.3(3).OPT1.GB6.PDF">http://www.wsdot.wa.gov/publications/fulltext/projectdev/gspspdf/6-08.3(3).OPT1.GB6.PDF</a>
Wyoming	See Question No. 7
Alberta	Questions 15 & 16: Section 16 of the Specifications for Bridge Construction. Question 17: Monitor or inspect surface preparation, temperature of membrane, thickness of membrane, installation of protection board, conformance to standard drawings and specifications.
Manitoba	Concrete surfaces to be shot blasted or sandblasted to expose sound, laitance free concrete and remove any materials that might adversely affect adhesion of the waterproofing membrane.
New Brunswick	Refer to Section 302.411.6 in Specifications Book
Nova Scotia	<a href="http://gov.ns.ca/tran/publications/standard.pdf">http://gov.ns.ca/tran/publications/standard.pdf</a> Division 5 Section 13
Ontario	See Specification OPS 914
Quebec	Standard specification for blast cleaning and waterproofing. Specification 6752 file_413279_151817376_1_terproofing.doc

## 8. COSTS

18. If available, please provide the unit cost (labor, equipment, and materials) for the waterproofing membrane system only for each project during the past five years. Please list as many as possible.

Respondent	New or Existing Deck	Unit Cost \$/sq ft
Alaska	New	2.22 to 7.44
Alaska	Existing	6.25
California	New	2.50 to 9.61
California	Existing	1.39 to 16.70
Connecticut	—	1.67 to 4.22
Illinois	Existing	2.46 to 9.14
Kansas	Existing	7.00
Michigan	Existing	5.00
Missouri	New	2.22 to 3.62
New Jersey	Both	1.5 to 12.00
New York	—	1.49 to 11.15
Oklahoma	Existing	2.18 to 3.89
Pennsylvania	Existing	7.95 to 21.56
South Carolina	New	9.75 to 42.80
South Dakota	Existing	10.84 to 23.00
Tennessee	Existing	0.56 to 1.10
Utah	Both	1.50 to 10.00
Virginia	Existing	3.33
Washington	New	2.78
Washington	Existing	1.11 to 4.22
Alberta	New	\$C 2.51 to 6.60
Alberta	Existing	\$C 3.25 to 8.55
New Brunswick	New	\$C 2.14 to 3.07
New Brunswick	Existing	\$C 2.79
Ontario	Both	\$C 2.32 to 2.79
Prince Edward Island	New	\$C 1.69 to 3.46
Quebec	Both	\$C 3.72
Saskatchewan	New	\$C 2.37
— Information not provided.		

## 9. PERFORMANCE

19. What defects has your agency observed in the performance of waterproofing membranes on new concrete bridge decks?

20. What defects has your agency observed in the performance of waterproofing membranes on existing concrete bridge decks?

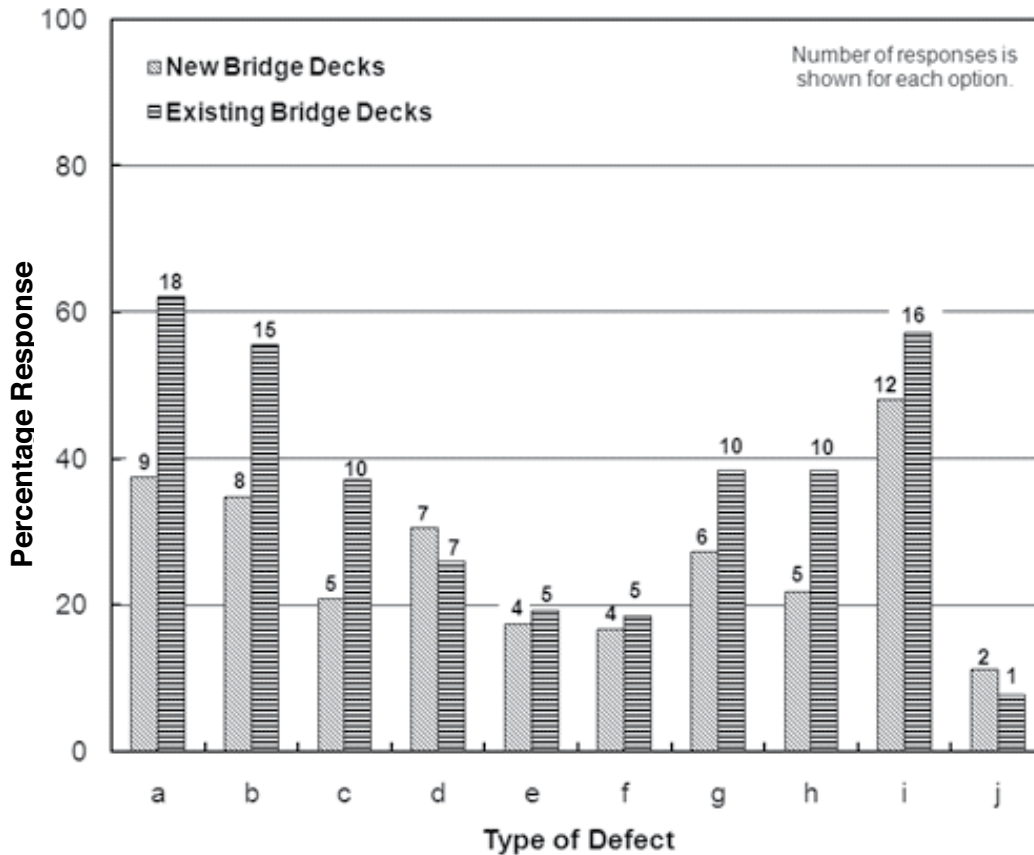

- a. Lack of adhesion between the waterproofing membrane and the concrete deck
  - b. Lack of adhesion between the waterproofing membrane and the asphalt surface
  - c. Punctured waterproofing membranes
  - d. Membrane blistering
  - e. Horizontal shear failure at the membrane
  - f. Cracks in the waterproofing membrane
  - g. Voids under the waterproofing membrane
  - h. Reinforcement corrosion
  - i. Moisture penetration through the membrane but cause unknown
  - j. Other
- If Other, please describe briefly.

Other defects included spalling and deterioration of the concrete deck below the membrane and insufficient thickness of materials.

**10. REPAIRS**

21. If your agency has requirements or specifications for repair of membrane systems, please provide details.

Respondent	Response
Alaska	When a waterproofing membrane is damaged, our procedure is to replace the entire waterproofing membrane.
New Hampshire	See Specification, Section 538.3.3.5.1
New York	Each manufacturer has provided guidance to repairs needed during installation of their product and how to ensure it is properly performed. See Materials Details for approved systems.
Tennessee	We don't repair membranes. We would replace them.
Utah	Utah DOT follows the repair recommendations provided by the manufacturers of each system used.

Table continued from p.53

Respondent	Response
Virginia	We patch delaminated epoxy membranes with new epoxy.
Washington	<a href="http://www.wsdot.wa.gov/publications/fulltext/projectdev/gspspdf/5-04.3(14).opt11.bsp.gb5.pdf">http://www.wsdot.wa.gov/publications/fulltext/projectdev/gspspdf/5-04.3(14).opt11.bsp.gb5.pdf</a> <a href="http://www.wsdot.wa.gov/publications/fulltext/projectdev/gspspdf/6-08.3(3).OPT1.GB6.PDF">http://www.wsdot.wa.gov/publications/fulltext/projectdev/gspspdf/6-08.3(3).OPT1.GB6.PDF</a> Any torn or cut areas, or narrow overlaps, shall be patched using a satisfactory adhesive and by placing sections of the membrane over the defective area in such a manner that the patch extends at least 6 in. beyond the defect. The patch shall be rolled or firmly pressed onto the surface.
Wyoming	See Question 7
Alberta	No. Repair would consist of full removal of failed area and re-application conforming to specification requirements.
New Brunswick	As per manufacturers recommendations
Ontario	We do not have requirements for repair. Depending on the nature and severity of the deficiency, our specifications provide for financial penalty, or removal and replacement of the membrane. See OPS 914.
Quebec	No except during first installation.

## 11. RESEARCH

22. Has your agency used any non-destructive testing to assess the condition of the in-place waterproofing membranes?

Yes: 7 agencies

No: 23 agencies

If Yes, what method was used?

The following non-destructive test methods were reported:

- Electrical conductivity
- Ground penetrating radar
- Electrical resistivity
- Chain drag or hammer sounding
- Visual inspection
- Leak testing

Was the method reliable?

Yes: 4 agencies

No: 3 agencies

The methods identified as being reliable were chain drag or hammer sounding, visual inspection, and leak testing. The methods identified as being unreliable were electrical conductivity, electrical resistivity, and ground penetrating radar.

23. Has your agency sponsored field studies or research on the performance of waterproofing membranes?

Yes: 7 agencies

No: 30 agencies

If reports are available, please supply a reference or source (person or website link) for further information, or a copy of the report.

The following research reports were listed:

*Bridge Deck Restoration Methods and Procedures*, Report No. FHWA/CA/SD-79/19.

Boisvert, D.M., *Evaluation of the Bond between Barrier Membrane and Concrete Bridge Decks*, Draft Report No. FHWA-NH-RD-12323G, January 2003, Draft report was not published.

New Brunswick Reports:

2005 CON-05-1208 *Audit of Bridge Deck Waterproofing Systems*

2005 CON-05-1201 *Review of Hot-Pour Waterproofing on Bridge Decks*



- 2002 DES-02-1172 *Comparative Performance of Rosphalt 50 to Soprema Waterproofing Membrane on Kennebecasis Structures*
- 2001 CON-01-1162 *Review of Bituthene 5000 Waterproofing Membrane Installed on New Brunswick Bridge Decks—1992–1996*
- 2000 MT-00-1158 *Field Evaluation of Bituthene 5000 Waterproofing Membrane*
- 2000 MT-00-1153 *Field Performance Review of Various Waterproofing Membranes*
- 1999 MT-99-1145 *Field Evaluation of Colphene Self Adhesive, Waterproofing Membrane*
- 1999 MT-99-1138 *Field Evaluation of Soprema Flam Antirock Waterproofing Membrane*
- 1992 RS-92-1028 *Additional Work on Field Test IV of a Waterproofing Membrane with Asphaltic Concrete Overlay using Jiffy Seal by Protecto Wrap*
- 1988 RS-88-1028 *Field Test IV of a Waterproofing Membrane with Asphaltic Concrete Overlay using Jiffy Seal by Protecto Wrap*
- 1987 RS-87-1019 *Field Test III of Waterproofing Membrane with AC Concrete Overlay*
- 1987 RS-87-1003 *Field Test II of Waterproofing Membrane with A.C. Overlay*
- 1987 RS-87-1002 *Adhesion Test of Asphalt Over Royston Waterproofing Membrane*

## 12. REASON FOR NONUSE

24. If your agency has not used or has discontinued the use of waterproofing membranes since 1994, please explain why and include details of unsuccessful experiences and reasons, if applicable.

The following reasons were provided for not using waterproofing membranes:

- Prefer to use bare concrete deck with integral wearing surface. Salt contaminated water can be trapped between the asphalt and the concrete, which then penetrates the concrete. Because the concrete surface is not visible, damage can go unnoticed until the asphalt deteriorates. By that time, the concrete damage can be serious.
- Do not salt bridge decks so there is no benefit to using a waterproofing membrane.
- We have very good concrete due to our good aggregates, very little freeze-thaw problems because of mild winters, and very few bridges exposed to coastal conditions.
- Poor performance and accelerated deterioration occurred in the past and the use of waterproofing membranes was discontinued.
- Have had very good success with concrete overlays and have not seen the need to use membranes.
- Only use waterproofing membranes as a last resort to extend the rideability of a deck that is in bad shape for one to four years.
- Specify permeability for our concrete bridge deck mix design and feel that this is adequate to achieve the required service life because we have limited use of de-icing salts.
- Have never been convinced that a membrane/overlay system presents a better more durable, maintenance-free riding surface.
- Experimented with membranes in the early 1970s and were not satisfied with the results. We prefer to use a low-slump concrete overlay or full-depth high-performance concrete deck.
- Prefer to use concrete polymer overlays.
- Use a bridge deck waterproofing surface course.
- Only used on hollow core slabs and box beam bridges.
- Cost-benefit ratio not attractive.
- Too many adhesion failures in the past.
- Exposed deck is preferred for inspection and maintenance.
- Due to low traffic volumes and little use of de-icing salts, we obtain good performance without a membrane.

Abbreviations used without definition in TRB Publications:

AAAE	American Association of Airport Executives
AASHO	American Association of State Highway Officials
AASHTO	American Association of State Highway and Transportation Officials
ACI-NA	Airports Council International-North America
ACRP	Airport Cooperative Research Program
ADA	Americans with Disabilities Act
APTA	American Public Transportation Association
ASCE	American Society of Civil Engineers
ASME	American Society of Mechanical Engineers
ASTM	American Society for Testing and Materials
ATA	Air Transport Association
ATA	American Trucking Associations
CTAA	Community Transportation Association of America
CTBSSP	Commercial Truck and Bus Safety Synthesis Program
DHS	Department of Homeland Security
DOE	Department of Energy
EPA	Environmental Protection Agency
FAA	Federal Aviation Administration
FHWA	Federal Highway Administration
FMCSA	Federal Motor Carrier Safety Administration
FRA	Federal Railroad Administration
FTA	Federal Transit Administration
IEEE	Institute of Electrical and Electronics Engineers
ISTEA	Intermodal Surface Transportation Efficiency Act of 1991
ITE	Institute of Transportation Engineers
NASA	National Aeronautics and Space Administration
NASAO	National Association of State Aviation Officials
NCFRP	National Cooperative Freight Research Program
NCHRP	National Cooperative Highway Research Program
NHTSA	National Highway Traffic Safety Administration
NTSB	National Transportation Safety Board
SAE	Society of Automotive Engineers
SAFETY-LU	Safe, Accountable, Flexible, Efficient Transportation Equity Act: A Legacy for Users (2005)
TCRP	Transit Cooperative Research Program
TEA-21	Transportation Equity Act for the 21st Century (1998)
TRB	Transportation Research Board
TSA	Transportation Security Administration
U.S.DOT	United States Department of Transportation

**TRANSPORTATION RESEARCH BOARD**

500 Fifth Street, N.W.

Washington, D.C. 20001

**ADDRESS SERVICE REQUESTED**

**THE NATIONAL ACADEMIES™**

*Advisers to the Nation on Science, Engineering, and Medicine*

The nation turns to the National Academies—National Academy of Sciences, National Academy of Engineering, Institute of Medicine, and National Research Council—for independent, objective advice on issues that affect people's lives worldwide.

[www.national-academies.org](http://www.national-academies.org)

ISBN: 978-0-309-22346-1



9 780309 223461