

SOUTH STAMFORD ACCESSIBILITY & MNRR BRIDGE REPLACEMENT FEASIBILITY STUDY

State Project No. 135-301
Stamford, Connecticut

PRELIMINARY ENGINEERING REPORT

Volume 7 of 7

PROPOSED PHASED CONSTRUCTION - *DRAFT*

(ATLANTIC STREET, ELM STREET, AND EAST MAIN STREET)

April 01, 2011

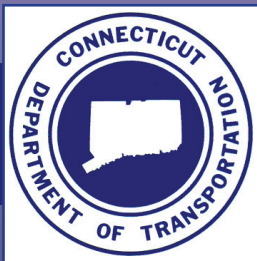

State of Connecticut
Department of Transportation

URS

500 Enterprise Dr, Ste 3B
Rocky Hill, CT 06067
Tel.: (860) 529-8882
Fax: (860) 529-3991
www.urscorp.com

TABLE OF CONTENTS – CORRIDOR (ATLANTIC, ELM & EAST MAIN STREET)

1. INTRODUCTION	1
1.1 Project Location and Description	1
1.2 Purpose of Project	2
1.3 Site Features	2
2. RAIL OPERATIONS	2
2.1 Rail Staging and Sequencing Requirements	2
2.2 Impact and Operational Issues of Proposed Construction	4
2.3 Summary and Conclusions	8
3. TRAFFIC	8
3.1 Traffic Operational Requirements	8
5. SUMMARY AND CONCLUSION	9

APPENDIX

Appendix A – Construction Schedule	11
Appendix B – Construction Cost Estimate	13
Appendix C – Figures	15

LIST OF FIGURES

Project Area

Figure 1.1 – Project Area

Rail Operations

Figure 2.1a-k – Rail Staging and Sequencing Plans for Bridges 08012R, 03686R & 02237R

Traffic

Figure 3.1a-g – Maintenance and Protection of Traffic

1. INTRODUCTION

1.1. Project Location and Description

This portion of the report analyzes the concurrent reconstruction of three bridges: Atlantic Street, Elm Street, and U.S. Route 1 (East Main Street). The bridges are all part of Metro-North’s New Haven line and are located at:

- Mile Post¹ 33.19 over Atlantic Street
- Mile Post 33.75 over Elm Street
- Mile Post 34.17 over East Main Street

In consideration of rail operations and to optimize track outage, it is recommended to reconstruct these three bridges concurrently. Construction will be accomplished one track at a time. It would require separate construction crews to be working simultaneously on each bridge; working in parallel to build the new substructure, get the track ready for operation, and advance to the next track outage. It is proposed that the construction staging proceed from south to north to avoid conflicts with simultaneous construction occurring on South State Street and U.S. Interstate 95 (I-95) at the beginning of the project.

Each structure type selected for the bridge location will be based on that bridge’s needs and constraints and will be further evaluated as the design progresses. The bridge structure type does not affect the order of operations and the intent of concurrently constructing the bridges. The only requirement is that constructability allows for the tracks to be taken out of service one track at a time and in sequence.

1.2. Site Features

The Greenwich Avenue undergrade² bridge is the furthest west of the five bridges making it the closest to Grand Central Terminal at mile post (MP) 32.81. Directly to the east of Greenwich Avenue is the Stamford Intermodal Transportation Center (SITC) and immediately following, is the Atlantic Street undergrade bridge. The Canal Street undergrade bridge is the next bridge along the New Haven Line and is within close proximity to the west access point of the Maintenance of Equipment facility. The Elm Street undergrade bridge located at MP 33.75 is just to the east of the “backdoor” to the Maintenance of Equipment facility. At this access point, transfer from Track 6 to 8 requires the use of a manual switch. Also within close proximity to the Elm Street undergrade crossing is a car wash facility frequently used by Metro-North Railroad (MNRR). Please refer to Figure 1.1 for a plan view of the project area, located in Appendix A.

¹ The mile post indicates the distance in miles from Grand Central Terminal.

² An “Undergrade Bridge,” when referring to the railroad, refers to a road going under the grade of the railroad or under the track. In the case of Stamford, the bridge acts to carry the tracks over each of the five roadways resulting in five undergrade bridges.

The East Main Street undergrade bridge is the bridge furthest east along the New Haven Line that was considered in this study. The bridge is located just before the New Canaan Branch diverges to the north, off the main line. Because of this bridge's proximity to the split, taking Track 5 out of service will cause a major disruption to the New Canaan line service. For this reason, it is proposed that a Track 3-5 cut-and-throw be installed while Track 5 is out of service.

1.3. Purpose of the Project

The purpose of this project is to open up access between Stamford locations north and south of the MNRR tracks. This will be accomplished by increasing roadway capacity at the MNRR undergrade bridges by replacing the bridges with longer span structures allowing additional travel lanes to pass under the MNRR tracks. The reconstruction of these bridges also removes structurally deficient bridges. All bridges were originally constructed in 1896 with rehabilitations in the 1930s and 1940s, and repairs in the 2000s. A Bridge Inspection Report dated October of 2008 cited the bridges to be in marginal to poor condition. Many of the bridges' superstructures have cracks, suffer from severe corrosion, and are locked up with girders touching the backwalls. The substructures are also considered to be in poor condition with spalling concrete and cracking.

The intention of the concurrent reconstruction these three bridges is to minimize disruption to rail operations. The Greenwich Avenue and Canal Street underpasses are not included with these three bridges and would need to be reconstructed independently, on their own track outage schedule. Including the Canal Street underpass would cause major disruptions to the access for the Maintenance of Equipment facility. Similarly for the Greenwich Avenue underpass, its inclusion in the concurrent reconstruction of the Atlantic, Elm, and East Main Street undergrade bridges would cause major disruptions to the SITC.

2. RAIL OPERATIONS

2.1. Rail Staging and Sequencing Requirements

The Atlantic Street bridge is an undergrade structure on the New Haven Line at MP 33.19 in Stamford. The bridge is situated between CP233 and CP234. Atlantic Street bridge is located approximately 500 feet east of the SITC. The bridge carries five tracks: the four New Haven Line tracks, numbered 3, 1, 2, and 4, and the New Canaan Branch (Track 5).

The Elm Street bridge is an undergrade structure on the New Haven Line at MP 33.75 in Stamford. The bridge is situated between CP234 and CP235. Elm Street bridge is located approximately 0.75 miles east of the SITC. The bridge carries seven tracks: the New Canaan Branch (Track 5), the four New Haven Line tracks, numbered 3, 1, 2, and 4, Yard Lead Track 6, and Yard Track 8.

The East Main Street bridge is an undergrade structure on the New Haven Line at MP 34.17 in Stamford. The bridge is situated between CP234 and CP235. East Main Street bridge is located approximately 1.17 miles east of the SITC. The bridge carries five tracks: the New Canaan Branch (Track 5), and the four New Haven Line tracks, numbered 3, 1, 2, and 4.

Replacement of these bridges will be done concurrently, one track at a time. The concurrent replacement work will require that when each track is taken out of service, the associated bridge replacement work for that portion of each bridge be done. The bridge replacement work can be done either working in the north to south, or the south to north direction. It is recommended that the outage progression be in a south to north direction to avoid conflicts with early construction work on South State Street and I-95, which are located north of the bridges.

The continuous track outages required for the reconstruction of the Atlantic Street bridge will impact the use of the SITC passenger platforms. During these outages, the normal routing of eastbound and westbound trains into the station area will have to be adjusted to accommodate the out-of-service tracks, and the out-of-service passenger platforms.

For the reconstruction of the Elm Street and East Main Street bridges, the installation of a temporary track cut-and-throw between Tracks 5 and 3 will be required. This track cut-and-throw will allow the continuous operation of the New Canaan Branch trains during the replacement of Track 5 on the Elm Street and East Main Street bridges. Two additional short track outage periods will also be required during this stage for the installation and removal of the temporary track throw.

During Stage 3 and Stage 7 of the project work, bridge plates at the Noroton Heights, Darien, and Rowayton Stations will be required. Bridge plates will be required as the Track 4 continuous outage in Stage 3 and the Track 3 continuous outage in Stage 7, extend east through these three stations.

The installation of a temporary passenger platform in Stamford Station will be required during Stage 6 of the project work. This platform will allow Track 1 to be used as a boarding/unloading track in the station area. Two additional short track outage periods will be required during this stage for the installation and removal of the temporary passenger platform.

During the Stage 1 work, Track 8 on the Elm Street bridge will be out of service. This track outage will impact train operations and access into yard Tracks 6, 8, 10, 12, the Lower Stamford Yard, and the Maintenance of Equipment facility.

The construction staging plans for Atlantic Street bridge, Elm Street bridge and East Main Street bridge (Please refer to Figures 2.1a – 2.1k, Rail Operations) shows the

reconstruction of the bridges being progressed in a south to north direction (Track 4 to Track 5 at Atlantic Street and East Main Street, and Track 8 to Track 5 at Elm Street).

The combined bridge reconstruction work is shown being done in seven main stages. Each of these stages will require a continuous track outage for the tracks being replaced at each bridge. It is estimated that the duration of the continuous track outage required for each track will be 150 calendar days.

With the mobilization period, the 150 calendar days required for each continuous track outage, and the approximate 5 month period to complete the roadway work under the bridges, the total project duration time for the replacement of the Atlantic Street, Elm Street, and East Main Street bridges is estimated to be 3 years, 11 months. A more precise construction schedule will be determined during final design.

2.2. Impact and Operational Issues of Proposed Construction

There will be a critical impact to Metro-North train operations when Track 5 is taken out-of-service for the reconstruction of the Elm Street and East Main Street bridges. There will also be a critical impact to train operations at Elm Street when Track 8 is taken out-of-service.

During the replacement of Track 8 on the Elm Street bridge, the lead tracks into Stamford Lower Yard will be taken out of service at the bridge. This will prevent train access into and out of the Lower Yard and the Stamford Maintenance of Equipment facility. This does not appear to be an area where a temporary crossover or track throw can be utilized to allow access and train movements to the Lower Yard. This part of the bridge construction will have a critical impact to Metro-North train operations.

Additional discussions with the CTDOT and Metro-North will be required to determine options available for maintaining train operations in this area, or transferring them to other locations.

When Track 5 is removed during the replacement of the Elm Street and East Main Street bridges, the New Canaan Branch will be taken out of service and normal train service on the branch line will not run. Busing service for the New Canaan Branch commuters was considered, but deemed impractical. After review by CTDOT and Metro-North, it was determined that a temporary Track 3-5 cut-and-throw be installed between Tracks 5 and 3, just east of the East Main Street bridge.

This temporary track realignment will allow the New Canaan Branch trains to be operated during the Track 5 bridge reconstruction at the Elm Street and East Main Street bridges. Minor track outages and limited weekend busing may be required during the installation and the removal of the track cut-and-throw.

Replacement of Yard Track 8 (Lower Yard Lead Tracks) - When Track 8 is taken out of service at the Elm Street bridge, the entrance to the Lower Stamford Yard will be blocked. Both lower Yard Lead Tracks L-1 and L-2 will be taken out of service.

The yard lead tracks are critical tracks that are used by all trains that originate and terminate in Stamford. These yard lead tracks are also used as access to the Maintenance of Equipment facility. This has a major impact to Metro-North train operations.

It does not appear that the Track 8 area just west of the Elm Street bridge can be reconfigured with the installation of a temporary crossover and/or track throw to allow access and train movements to the yard lead tracks and the Lower Stamford Yard. Other possible options for maintaining, or temporarily moving train operations in this area will have to be further discussed with the CTDOT and Metro-North.

Replacement of Yard Track 6 - When Track 6 is taken out of service at the Elm Street bridge, a section of Yard Track 6 will be removed over the Elm Street bridge. Trains will be able to run around the bridge construction work on Track 6 by using Track 8 and the 6-8 and 8-6 crossovers on each side of the Elm Street bridge.

Replacement of Track 4 - When Track 4 is taken out of service at the Atlantic Street bridge, the passenger platform for Track 4 at the station will also be out of service for eastbound and westbound trains.

Eastbound trains on Track 4 will use SELLECK (CP232) to divert to one of the three adjacent in-service passenger platform tracks or to Track 1 in the station area.

Track 4 will also be out of service between SELLECK (CP232) and CP240, except for the 2-4 and 4-6 crossovers in CP234. The 4-6 crossover into and out of the yard will be in service for originating and terminating trains. This outage will also require that westbound trains on Track 4 use CP240 and CP241 to divert to one of the other three adjacent in-service through tracks in the SITC.

When Track 4 is taken out of service at the Elm Street and East Main Street bridges, eastbound trains on Track 4 will use the crossovers in SELLECK (CP232) to divert to one of the adjacent in-service tracks to run around the Track 4 bridge work on these bridges.

When Track 4 is out of service at the Elm Street and East Main Street bridges, bridge plates will be required at the Noroton Heights, Darien, and Rowayton passenger stations.

Westbound trains on Track 4 will use the crossovers in CP240 and CP241 to divert from Track 4 to an adjacent in-service track to run around the Track 4 outage at the Elm Street and East Main Street bridges.

Replacement of Track 2 - When Track 2 at the Atlantic Street bridge is taken out of service, the passenger platform in the station for Track 2 will be out of service for eastbound and westbound trains.

Eastbound trains on Track 2 will use SELLECK or CP233 to divert to one of the other three adjacent in-service passenger platform tracks or to Track 1, in the station area.

Westbound trains on Track 2 will be required to use the crossovers in CP234 to divert to one of the other three adjacent in-service passenger platform tracks or to Track 1, in the station area.

When Track 2 at the Elm Street and East Main Street bridges is taken out of service, eastbound trains on Track 2 will use the crossovers in CP234 to divert to one of the adjacent in-service tracks to run around the bridge work on Track 2.

Westbound trains on Track 2 will use the crossovers in CP240 and CP241 to divert from Track 2 to an adjacent in-service track to run around the Track 2 outage at the Elm Street and East Main Street bridges.

Replacement of Track 1 - When Track 1 at the Atlantic Street bridge is taken out of service, through Track 1 in the station area will also be out of service for eastbound and westbound trains. The Track 1 outage on the bridge will not require any of the four platform tracks in the SITC to be taken out of service. Through Track 1 in the station will be out of service for eastbound and west bound trains.

Eastbound trains on Track 1 will be diverted from Track 1 in SELLECK or CP233 to one of the four in-service passenger platform tracks in the station area.

Westbound trains on Track 1 will be required to use the crossover(s) in CP234 to divert to one of the other four adjacent in-service passenger platform tracks in the station area.

When Track 1 at the Elm Street and East Main Street bridges is taken out of service, eastbound trains on Track 1 will use the crossovers in CP234 and CP235 to run around the bridge work on Track 1.

Westbound trains on Track 1 will be able to use the 3-1 crossover in CP235, and the crossovers in CP234 to run around the Track 1 outage at the Elm Street and East Main Street bridges.

Replacement of Track 3 - When Track 3 at the Atlantic Street bridge is taken out of service, Track 3 through the station area will also be out of service. The installation of a temporary passenger platform at Track 3 in the station will be required to allow trains to board and unload passengers from Track 1. The temporary platform is required to

maintain an adequate number of passenger platform tracks at the SITC to facilitate train operations during this stage of the work.

When Track 3 at the Atlantic Street, Elm Street and East Main Street bridges is out of service, Track 3 between CP234 and CP235 will also be out of service (except for use of the 1-3 and 3-5 crossovers).

Eastbound trains on Track 1 will be able to use the temporary passenger platform over Track 3, or be diverted in SELLECK to one of the other three in-service passenger platforms in Stamford Station. Eastbound trains on Track 3/5 will be able to use the 5-3 crossover in CP235 to divert to Track 3.

Westbound trains on Track 3 will be able to use the 5-3 crossover in CP235 to divert to Track 5 to run around the bridge work on Track 3. Westbound trains on Track 1 will be able to use the temporary platform over Track 3 in Stamford Station for boarding and disembarking passengers.

Replacement of Track 5 (New Canaan Branch) - When Track 5 at the Elm Street and East Main Street bridges is taken out of service, the installation of a temporary cut and throw between Tracks 5 and 3 will be required. This temporary track realignment will allow operation of the New Canaan Branch train service during the Track 5 reconstruction work.

During this stage of the work, bridge plates will be required at the Noroton Heights, Darien, and Rowayton Stations.

The Track 5 outage at the Atlantic Street bridge will not require any of the four passenger platform tracks or through Track 1 in the SITC to be taken out of service. Eastbound and westbound trains will be able to use all four of the platform tracks and Track 1 in the station area.

Eastbound trains on Track 5 will use the 5-3 crossover in CP234 to divert to Track 3, and the Track 3-5 cut and throw to divert to Track 5 and then continue up the New Canaan Branch.

Westbound trains on Track 5 (New Canaan Branch) will use the Track 3-5 cut and throw to divert to Track 3, and the 5-3 crossover in CP234 to divert to the Track 5 passenger platform track.

The Track 3-5 cut and throw will be removed, and the normal alignment of Tracks 5 and three restored when the Track 5 bridge work is completed on the Elm Street and East Main Street bridges.

2.3. Summary and Conclusions

Construction of the Atlantic Street bridge will impact train operations both east and west of the SITC. Use of the SITC passenger platform tracks will also be impacted during each stage of the reconstruction of this bridge.

The Atlantic Street bridge construction will require adjustments to train operations through the SITC area. Reconstruction of the Track 3 portion of the bridge will require that a temporary platform be installed in the station over Track 3 to allow passenger boarding/un-loading from Track 1. The Atlantic Street bridge work will also require several adjustments to normal train routing both east and west of the Stamford Station area during reconstruction of each of the tracks on this bridge.

Construction of the Elm Street bridge will impact train operations on the New Canaan Branch, in CP234, and access into the Lower Stamford Yard and the Stamford Maintenance of Equipment facility. The bridge reconstruction will also require the installation of a temporary Track 3-5 cut and throw for continued operation of the New Canaan Branch train service. Further discussions with CTDOT and Metro-North are necessary to consider other options for minimizing impacts to train operations and access to the Lower Stamford Yard and the Maintenance of Equipment facility when Track 8 on Elm Street is reconstructed.

Construction of the East Main Street bridge will impact train operations on the New Canaan Branch and in CP234. The bridge reconstruction will also require the installation of a temporary Track 3-5 cut and throw for continued operation of the New Canaan Branch train service.

The Elm Street and East Main bridge construction will not substantially impact train operations on the SITC tracks. Bridge plates will be required at the Noroton Heights, Darien, and Rowayton passenger stations during two different stages of the work.

3. TRAFFIC

3.1. Maintenance and Operation of Traffic

Although the traffic impacts associated with the bridge replacement project would be minimized if the reconstruction of each bridge occurred at separate times, the combination of these projects sequentially would take over a decade to complete. Impacts to the travelling public, both roadway and railway, would be substantial for an unreasonable length of time. In addition, impacts on railroad operations would continue for an extended period, and unacceptable operating conditions would result. In an effort to reduce the project duration and lessen the impacts to both the railroad and the traveling public, it has been determined that three bridges can be replaced concurrently. The three bridges are Atlantic Street, Elm Street and East Main Street. Please refer to Figures 3.1 to 3.3d for Roadway MPT plans at each bridge location.

The proposed construction sequencing for the East Main Street bridge calls for the relocation of utilities and lowering of the street to final grade prior to the start of structural work on the bridge. Once this work is done, two operational lanes will be maintained for the remainder of the project. By maintaining two operational lanes, the roadway will have essentially the same capacity as it does at present, with the only reduction in capacity resulting from the friction of traffic operating in a construction zone.

Atlantic Street is proposed to be closed, with some partial operations possible at later stages in the construction schedule.

It is anticipated that a single lane of operational traffic will be maintained throughout construction on Elm Street. Traffic will be detoured to use either Canal Street or Myrtle Street to East Main Street. It is recommended that Elm Street not be closed before the East Main Street traffic is restored to two-lane operation following the initial utility relocations and profile adjustments.

Although concurrent construction at these three locations will cause the detouring and redirection of traffic around the construction sites, most of the detoured vehicles will be able to use independent travel routes. Incremental congestion should be minimized by coordinating the bridge projects as noted above.

5. SUMMARY AND CONCLUSIONS

It is recommended that the Atlantic Street, Elm Street and East Main Street bridges be considered for reconstruction in the same time frame. This is recommended because Elm Street and East Main Street bridges have the same train operation issues with the New Canaan Branch service when Track 5 is taken out of service at these bridges. Concurrent construction of these bridges will share the train operation inconveniences in a single construction sequencing period, as opposed to have to having to deal with the issues twice in non-concurrent construction timeframes.

The Atlantic Street bridge is also recommended for replacement in the same construction time frame as the Elm Street and East Main Street bridges. Most of the train operation adjustments and re-routing used for the construction of the Elm Street and East Main Street bridges, can also be used during the reconstruction of the Atlantic Street bridge. The reconstruction of the Atlantic Street bridge in the same time frame as the reconstruction of the Elm Street and East Main Street bridges does not appear to cause much additional impact on train operations at the SITC.

In addition to a time savings by constructing these bridges concurrently, a cost savings of approximately \$10,000,000 will be realized by constructing these bridges simultaneously for a total construction cost of \$150,000,000. This is seen as a cost savings through the MNRR Force Account expenses by sharing MNRR resources mostly between the work performed at the Elm Street and the East Main Street bridge and common use of the Track 3-5 cut and

throw. For construction cost specifics for each bridge, please refer to the individual bridge volumes for more detail.

APPENDIX A – CONSTRUCTION SCHEDULE

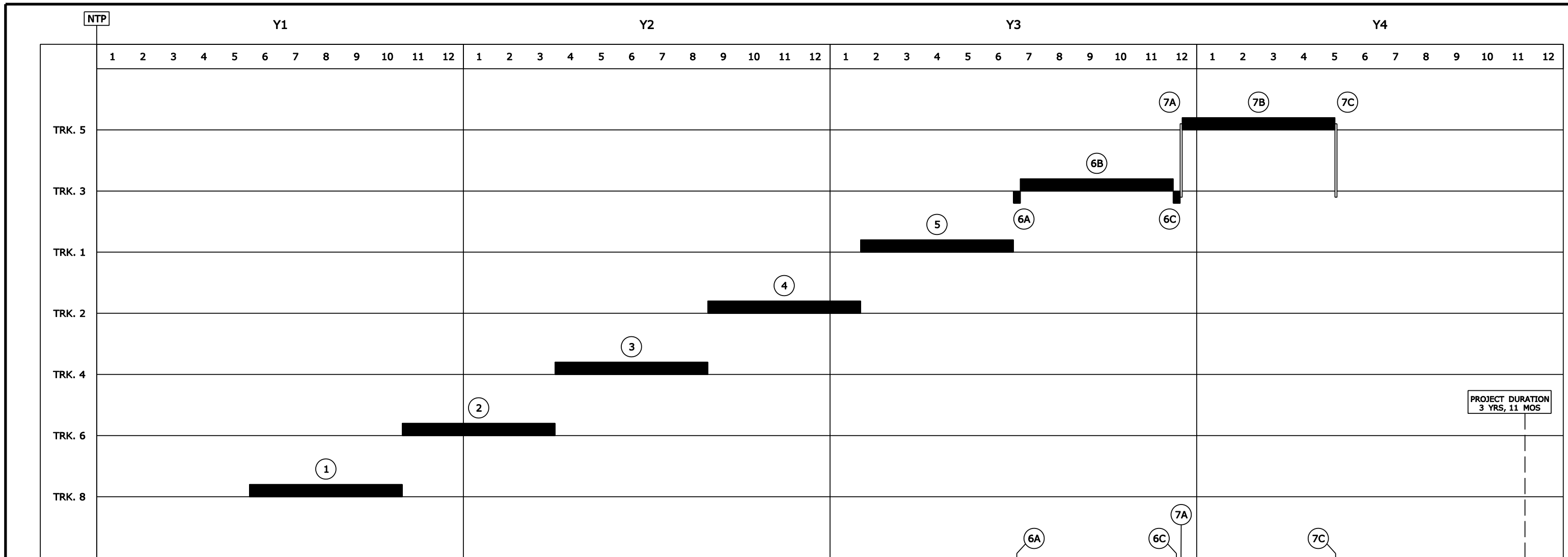

PROJECT DURATION
3 YRS, 11 MOS

STAGE NO.	MOBILIZATION STAGE	1	2	3	4	5	6A	6B	6C	7A	7B	7C
CALENDAR DAYS	150	150	150	150	150	150	7	150	7	2	150	2

ATLANTIC STREET (ROAD WORK)	REMOVE EX. ABUTMENTS	INSTALL ROADWAY
--------------------------------	----------------------	-----------------

ELM STREET (ROAD WORK)	REMOVE EX. ABUTMENTS	INSTALL ROADWAY
---------------------------	----------------------	-----------------

EAST MAIN STREET (ROAD WORK)	REMOVE EX. ABUTMENTS	INSTALL ROADWAY
---------------------------------	----------------------	-----------------

LEGEND:

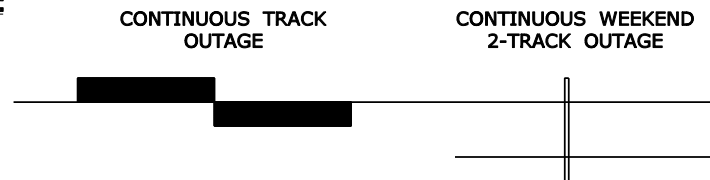

SOUTH STAMFORD ACCESSIBILITY
& MNRR BRIDGE REPLACEMENT
FEASIBILITY STUDY

ATLANTIC STREET, ELM STREET
& EAST MAIN STREET

TRACK OUTAGE SCHEDULE

URS

SCALE: N.T.S.

APPENDIX B – CONSTRUCTION COST ESTIMATE



South Stamford Accessibility and MNRR Bridge Replacement Feasibility Study

Stamford, Connecticut
 State Project No. 135-301

**PRELIMINARY ENGINEERING CONSTRUCTION COST ESTIMATE
 PHASE I CONSTRUCTION**

Description	Phase 1 Construction	Phase 1 Construction
	Combined Construction Cost Totals	Individual Bridge Cost Totals
	Price	Price
Project Total		
Atlantic Street - Alternate 2	\$36,282,032.59	\$36,282,032.59
Elm Street	\$27,877,155.21	\$27,877,155.21
East Main Street	\$30,494,614.13	\$30,494,614.13
Section Sub-Total	\$94,653,801.93	\$94,653,801.93
Utility Relocation Costs		
Atlantic Street - Alternate 2	\$3,157,500.00	\$3,157,500.00
Elm Street	\$1,563,500.00	\$1,563,500.00
East Main Street	\$1,585,500.00	\$1,585,500.00
Section Sub-Total	\$6,306,500.00	\$6,306,500.00
Railroad Costs (incl. Force Account)		
Atlantic Street - Alternate 2	\$8,598,150.00	\$8,598,150.00
Elm Street	\$10,574,980.00	\$10,574,980.00
East Main Street	\$13,502,175.00	\$13,502,175.00
Net Savings by constructing 3 bridges at once	-\$7,000,000.00	\$0.00
Section Sub-Total	\$25,675,305.00	\$32,675,305.00
Incidentals and Contingencies (applied to Project Total)		
1. Incidentals @	15% \$14,198,070.29	18% \$17,037,684.35
2. Contingencies @	10% \$9,465,380.19	10% \$9,465,380.19
Section Sub-Total	\$23,663,450.48	\$26,503,064.54
Cost of Bridge Rehabilitation (2011)	\$150,299,057.42	\$160,138,671.48
SAY	\$150,300,000.00	\$160,100,000.00

Project Cost Escalation Footnotes:

1. Estimated construction cost shown above is based on 2011 prices.
2. Rate of construction cost escalation is estimated at 5% per year, per CTDOT Estimating Guidelines, calculated to the mid-point of construction, which is anticipated to be 2016 based on an anticipated 2014 start of construction. Accordingly, the cost escalation factor is 1.28.

APPENDIX C - FIGURES

LIST OF FIGURES

Project Area

Figure 1.1 – Project Area

Rail Operations

Figure 2.1a-k – Rail Staging and Sequencing Plans for Bridges 08012R, 03686R & 02237R

Traffic

Figure 3.1a-g – Maintenance and Protection of Traffic

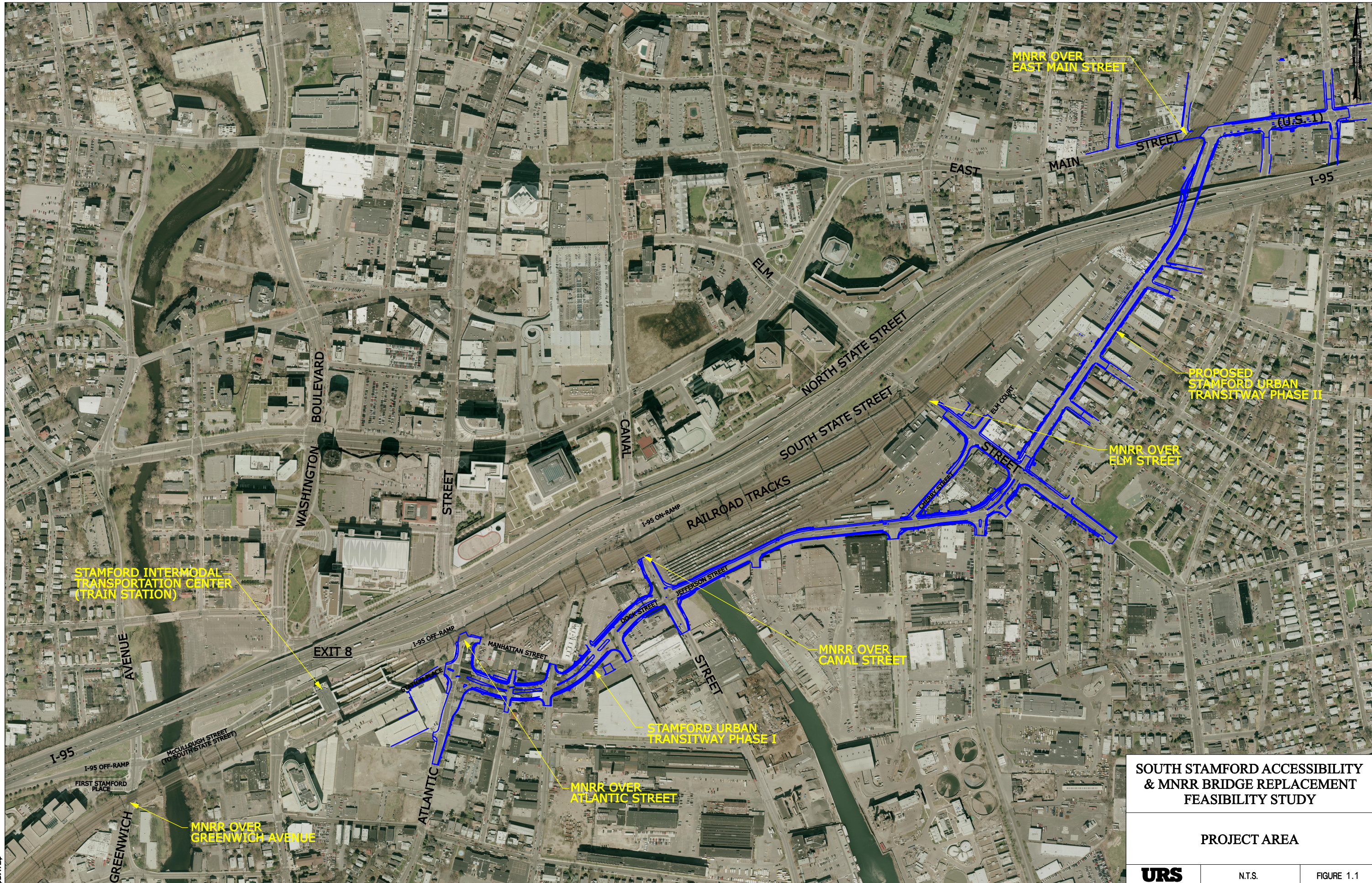

SOUTH STAMFORD ACCESSIBILITY & MNRR BRIDGE REPLACEMENT FEASIBILITY STUDY

PROJECT AREA

URS

N.T.S.

FIGURE 1.1

FILES & DATES

LEGEND:

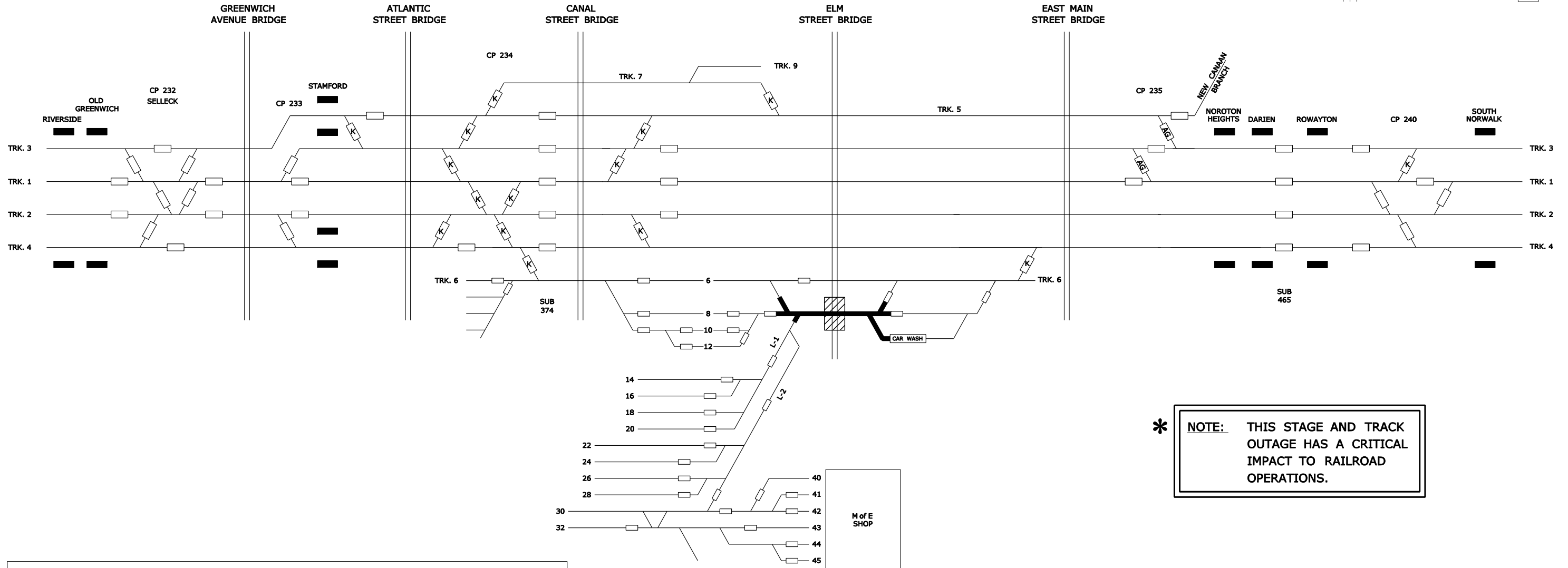
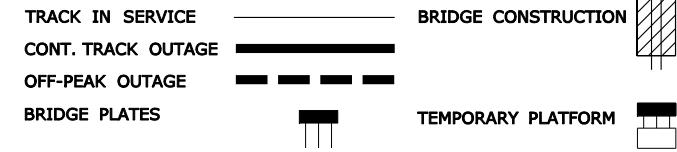

*** NOTE:** THIS STAGE AND TRACK OUTAGE HAS A CRITICAL IMPACT TO RAILROAD OPERATIONS.

STAGE	TASK	TRACK	TRACK OUTAGE
①	1) REMOVE TRACK 8 AT ELM ST. 2) REMOVE EXISTING STEEL SUPERSTRUCTURE 3) INSTALL NEW ABUTMENTS 4) INSTALL NEW CENTER PIER 5) CUT BACK TOPS OF EXISTING ABUTMENTS 6) INSTALL NEW SUPERSTRUCTURE 7) INSTALL NEW TRACK 8 AT ELM ST.	8	CONTINUOUS TRACK OUTAGE *

**SOUTH STAMFORD ACCESSIBILITY
 & MNRR BRIDGE REPLACEMENT
 FEASIBILITY STUDY**

**ATLANTIC STREET, ELM STREET
 & EAST MAIN STREET
 CONSTRUCTION STAGING**

STAGE ①

URS	SCALE: N.T.S.	FIGURE 2.1a
------------	---------------	-------------

LEGEND:

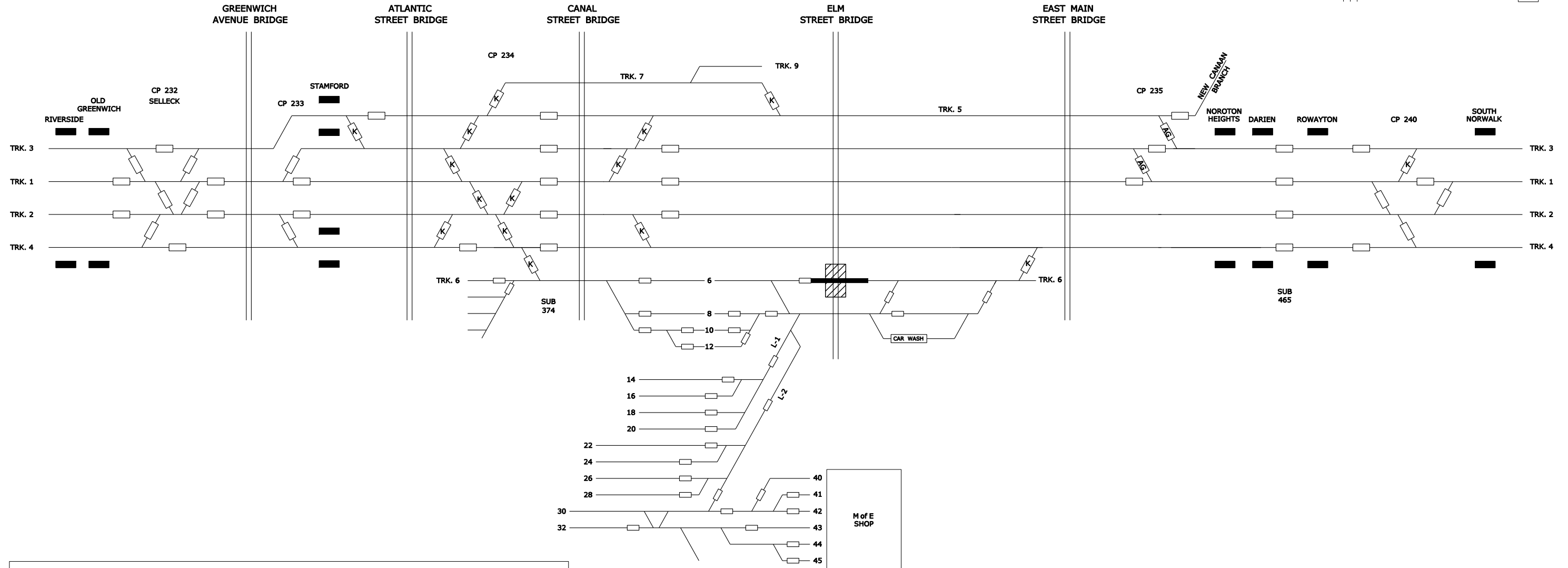
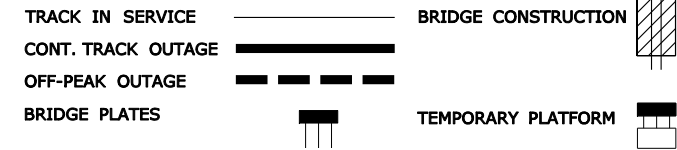

STAGE	TASK	TRACK	TRACK OUTAGE
2	1) REMOVE TRACK 6 AT ELM ST. 2) REMOVE EXISTING STEEL SUPERSTRUCTURE 3) INSTALL NEW ABUTMENTS 4) INSTALL NEW CENTER PIER 5) CUT BACK TOPS OF EXISTING ABUTMENTS 6) INSTALL NEW SUPERSTRUCTURE 7) INSTALL NEW TRACK 6 AT ELM ST.	6	CONTINUOUS TRACK OUTAGE

SOUTH STAMFORD ACCESSIBILITY & MNRR BRIDGE REPLACEMENT FEASIBILITY STUDY

ATLANTIC STREET, ELM STREET & EAST MAIN STREET CONSTRUCTION STAGING

STAGE 2



SCALE: N.T.S.

FIGURE 2.1b

LEGEND:

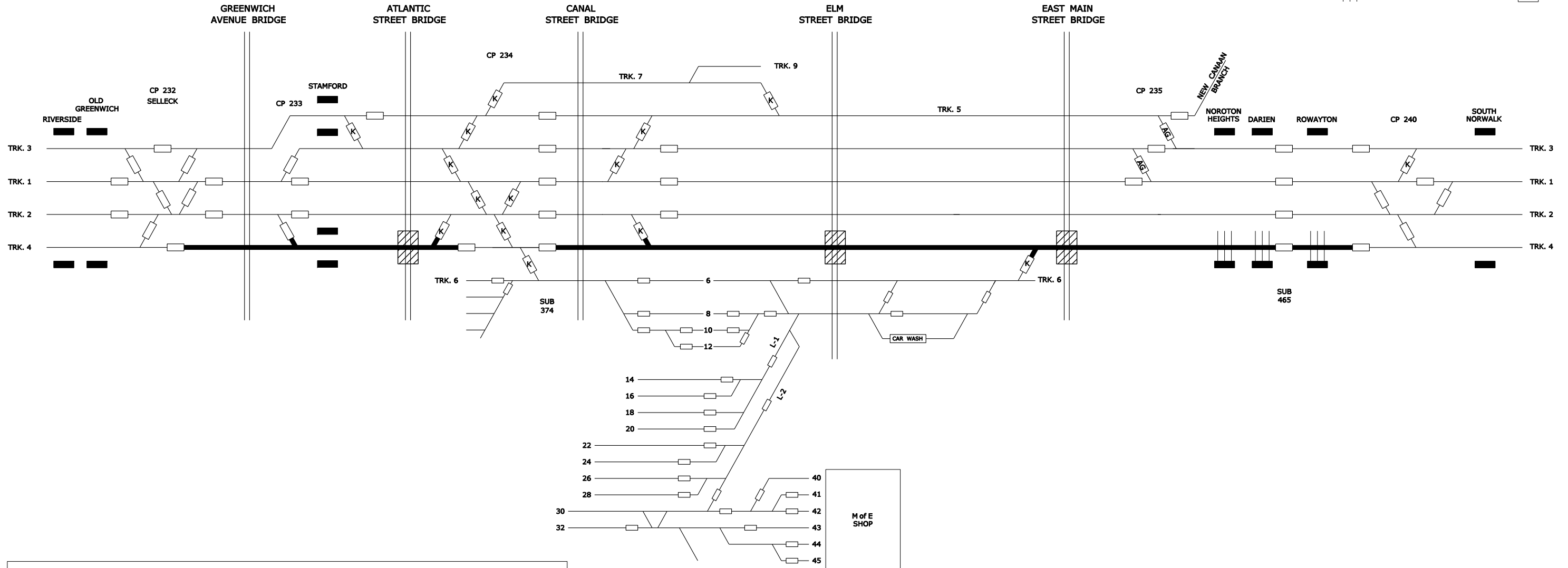
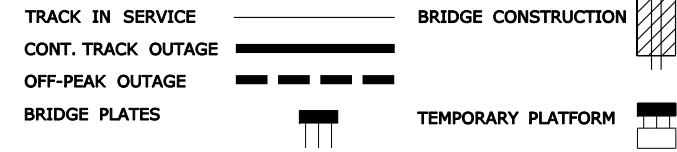

STAGE	TASK	TRACK	TRACK OUTAGE
3	1) INSTALL BRIDGE PLATES AT NORTON HEIGHTS, DARIEN, AND ROWAYTON	4	OFF PEAK WEEKEND NIGHT OUTAGE
	2) REMOVE TRACK 4 AT ATLANTIC ST. REMOVE TRACK 4 AT ELM ST. REMOVE TRACK 4 AT EAST MAIN ST.	4	CONTINUOUS TRACK OUTAGE
	3) REMOVE EXISTING STEEL SUPERSTRUCTURE		
	4) INSTALL NEW ABUTMENTS		
	5) INSTALL NEW CENTER PIER		
	6) CUT BACK TOPS OF EXISTING ABUTMENTS		
	7) INSTALL NEW SUPERSTRUCTURE		
	8) INSTALL NEW TRACK 4 AT ATLANTIC ST. INSTALL NEW TRACK 4 AT ELM ST. INSTALL NEW TRACK 4 AT EAST MAIN ST.		
	9) REMOVE ALL BRIDGE PLATES	4	OFF PEAK WEEKEND NIGHT OUTAGE

SOUTH STAMFORD ACCESSIBILITY & MNRR BRIDGE REPLACEMENT FEASIBILITY STUDY

ATLANTIC STREET, ELM STREET & EAST MAIN STREET CONSTRUCTION STAGING

STAGE 3

LEGEND:

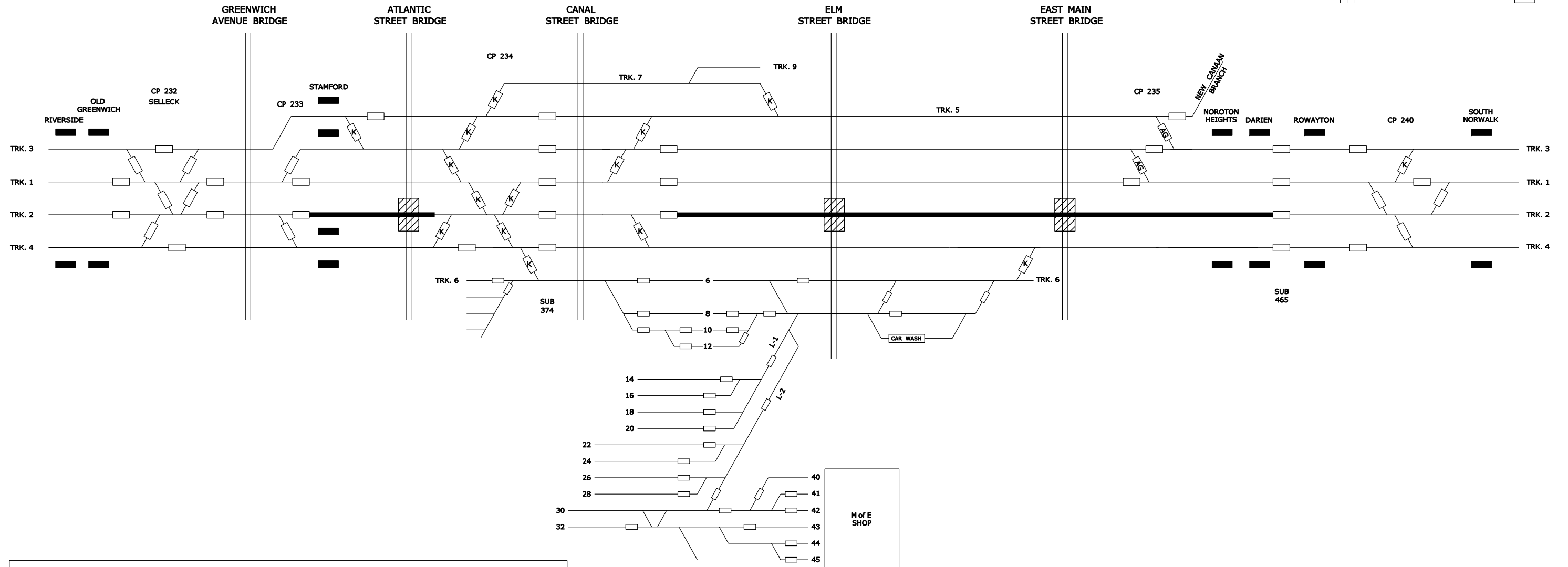
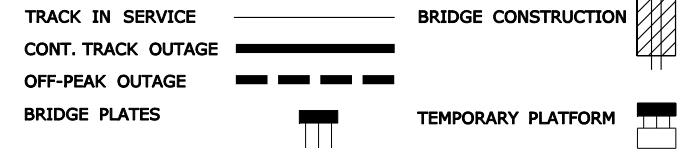

STAGE	TASK	TRACK	TRACK OUTAGE
4	1) REMOVE TRACK 2 AT ATLANTIC ST. REMOVE TRACK 2 AT ELM ST. REMOVE TRACK 2 AT EAST MAIN ST. 2) REMOVE EXISTING STEEL SUPERSTRUCTURE 3) INSTALL NEW ABUTMENTS 4) INSTALL NEW CENTER PIER 5) CUT BACK TOPS OF EXISTING ABUTMENTS 6) INSTALL NEW SUPERSTRUCTURE 7) INSTALL NEW TRACK 2 AT ATLANTIC ST. INSTALL NEW TRACK 2 AT ELM ST. INSTALL NEW TRACK 2 AT EAST MAIN ST.	2	CONTINUOUS TRACK OUTAGE

**SOUTH STAMFORD ACCESSIBILITY
& MNRR BRIDGE REPLACEMENT
FEASIBILITY STUDY**

**ATLANTIC STREET, ELM STREET
& EAST MAIN STREET
CONSTRUCTION STAGING**

STAGE 4

URS	SCALE: N.T.S.	FIGURE 2.1d
------------	---------------	-------------

LEGEND:

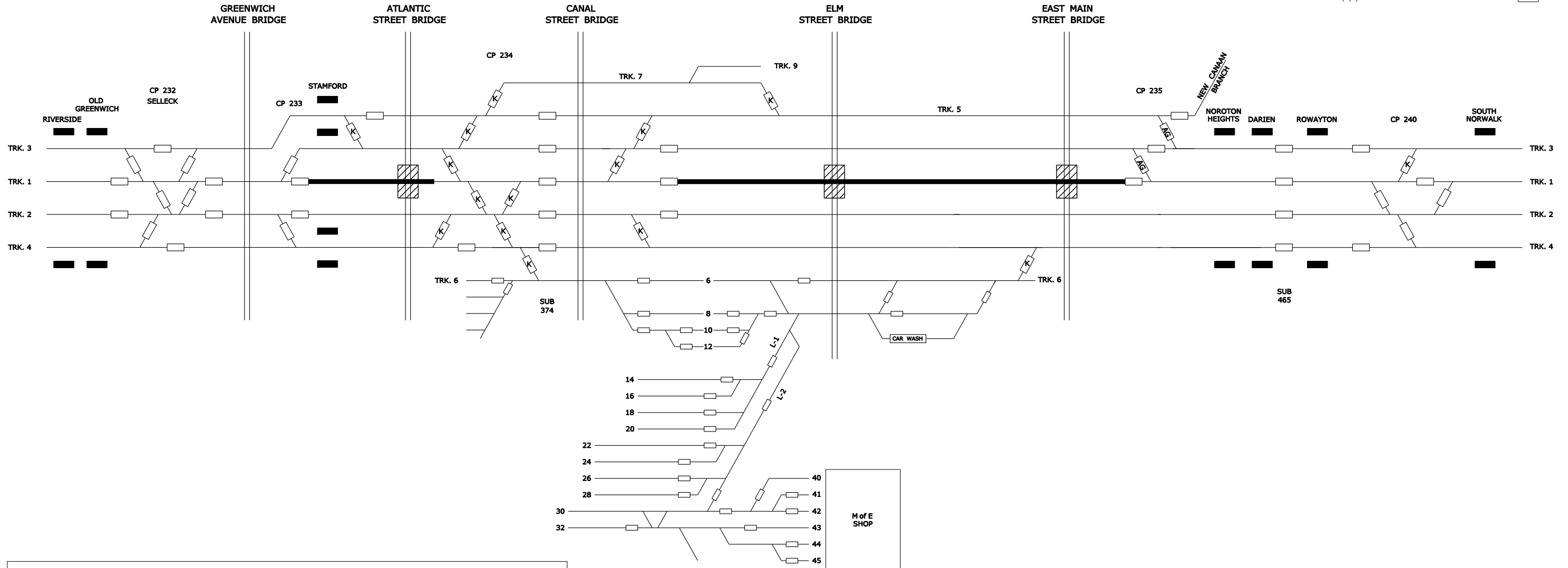
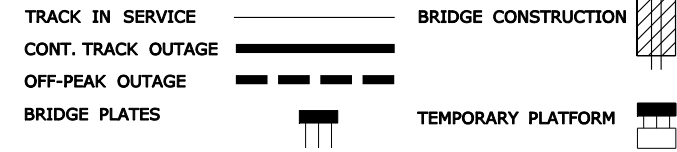

STAGE	TASK	TRACK	TRACK OUTAGE
5	1) REMOVE TRACK 1 AT ATLANTIC ST. REMOVE TRACK 1 AT ELM ST. REMOVE TRACK 1 AT EAST MAIN ST. 2) REMOVE EXISTING STEEL SUPERSTRUCTURE 3) INSTALL NEW ABUTMENTS 4) INSTALL NEW CENTER PIER 5) CUT BACK TOPS OF EXISTING ABUTMENTS 6) INSTALL NEW SUPERSTRUCTURE 7) INSTALL NEW TRACK 1 AT ATLANTIC ST. INSTALL NEW TRACK 1 AT ELM ST. INSTALL NEW TRACK 1 AT EAST MAIN ST.	1	CONTINUOUS TRACK OUTAGE

**SOUTH STAMFORD ACCESSIBILITY
& MNRR BRIDGE REPLACEMENT
FEASIBILITY STUDY**

**ATLANTIC STREET, ELM STREET
& EAST MAIN STREET
CONSTRUCTION STAGING**

STAGE 5

URS	SCALE: N.T.S.	FIGURE 2.1e
------------	---------------	-------------

LEGEND:

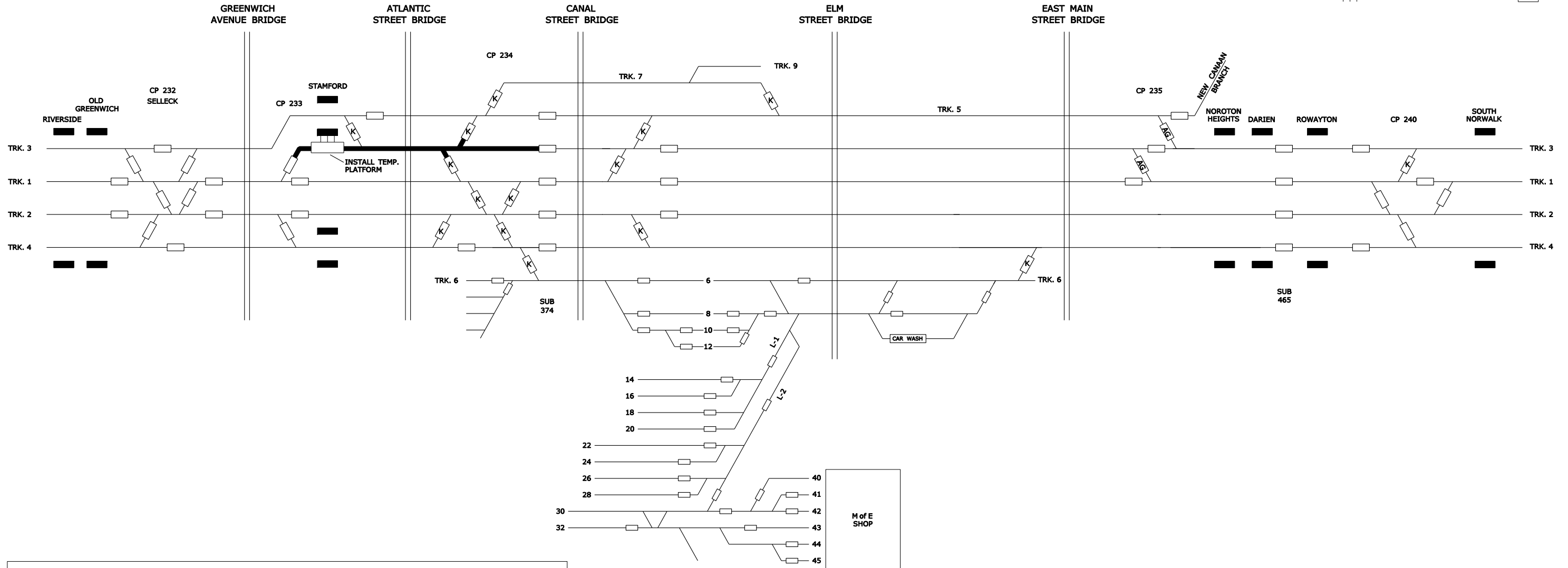
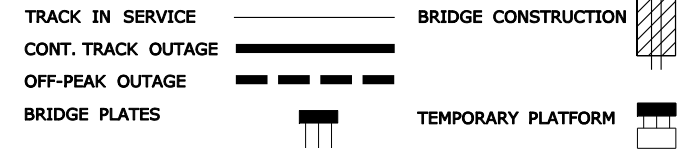

STAGE	TASK	TRACK	TRACK OUTAGE
6A	1) INSTALL TEMPORARY PASSENGER PLATFORM AT STAMFORD STATION	3	CONTINUOUS TRACK OUTAGE

SOUTH STAMFORD ACCESSIBILITY & MNR BRIDGE REPLACEMENT FEASIBILITY STUDY

ATLANTIC STREET, ELM STREET & EAST MAIN STREET CONSTRUCTION STAGING

STAGE 6A

URS	SCALE: N.T.S.	FIGURE 2.1f
------------	---------------	-------------

LEGEND:

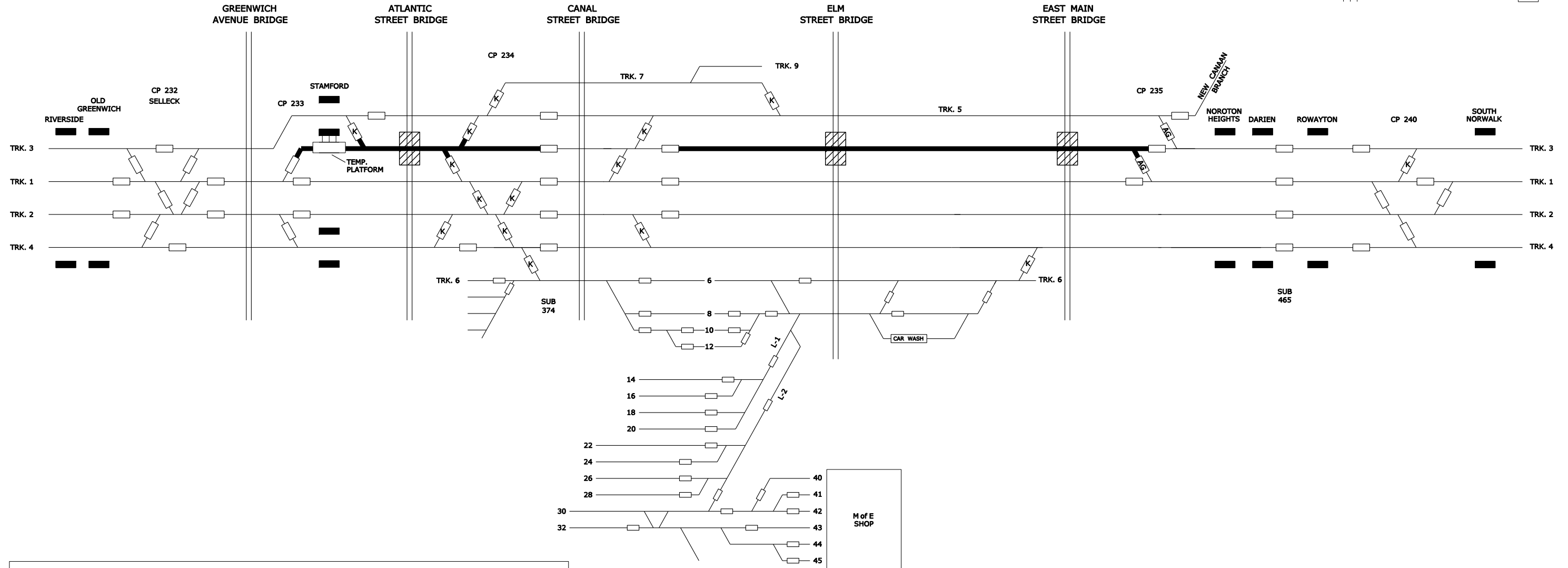
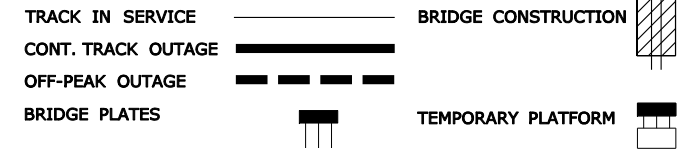

STAGE	TASK	TRACK	TRACK OUTAGE
6B	1) REMOVE TRACK 3 AT ATLANTIC ST. REMOVE TRACK 3 AT ELM ST. REMOVE TRACK 3 AT EAST MAIN ST. 2) REMOVE EXISTING STEEL SUPERSTRUCTURE 3) INSTALL NEW ABUTMENTS 4) INSTALL NEW CENTER PIER 5) CUT BACK TOPS OF EXISTING ABUTMENTS 6) INSTALL NEW SUPERSTRUCTURE 7) INSTALL NEW TRACK 3 AT ATLANTIC ST. INSTALL NEW TRACK 3 AT ELM ST. INSTALL NEW TRACK 3 AT EAST MAIN ST.	3	CONTINUOUS TRACK OUTAGE

**SOUTH STAMFORD ACCESSIBILITY
& MNRR BRIDGE REPLACEMENT
FEASIBILITY STUDY**

**ATLANTIC STREET, ELM STREET
& EAST MAIN STREET
CONSTRUCTION STAGING**

STAGE 6B

URS

SCALE: N.T.S.

FIGURE 2.1g

LEGEND:

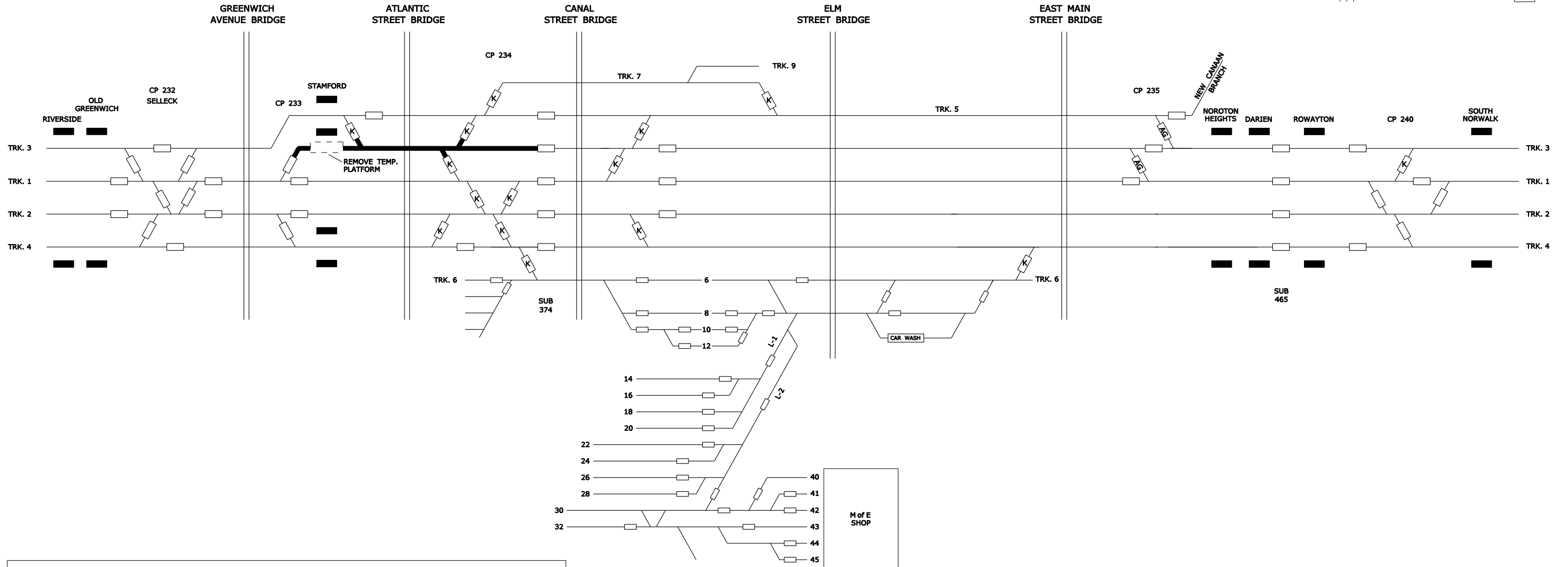
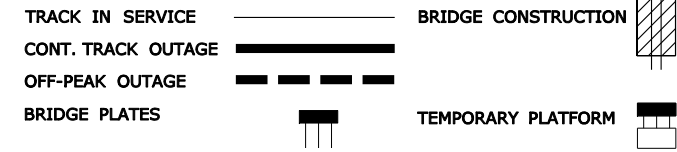

STAGE	TASK	TRACK	TRACK OUTAGE
6C	1) REMOVE TEMPORARY PASSENGER PLATFORM AT STAMFORD STATION.	3	CONTINUOUS TRACK OUTAGE

**SOUTH STAMFORD ACCESSIBILITY
& MNRR BRIDGE REPLACEMENT
FEASIBILITY STUDY**

**ATLANTIC STREET, ELM STREET
& EAST MAIN STREET
CONSTRUCTION STAGING**

STAGE 6C

URS

SCALE: N.T.S.

FIGURE 2.1h

LEGEND:

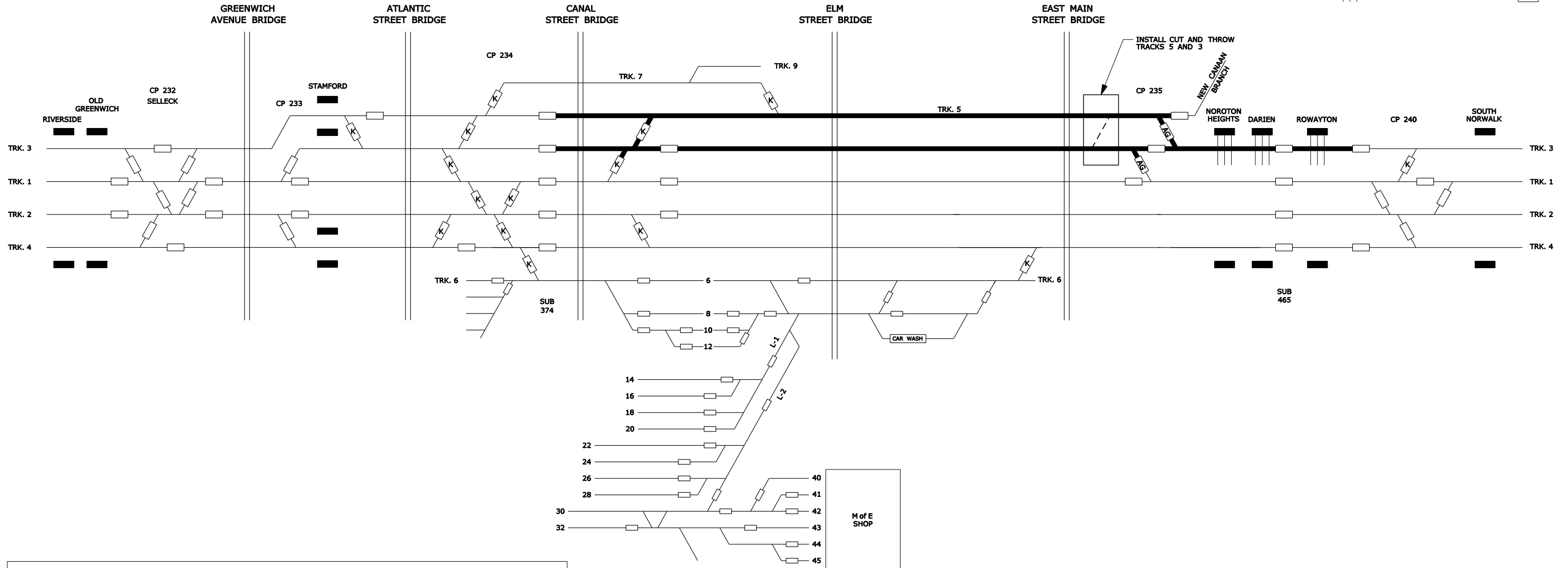
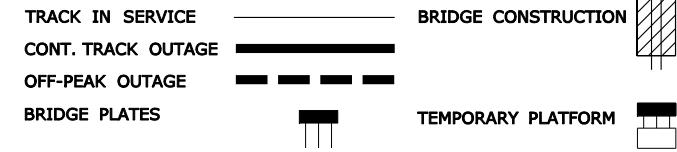

STAGE	TASK	TRACK	TRACK OUTAGE
7A	1) INSTALL BRIDGE PLATES AT NORTON HEIGHTS DARIEN, ROWAYTON.	3	OFF PEAK WEEKEND NIGHT OUTAGE
	2) INSTALL CUT AND THROW TRACKS 5 AND 3	5,3	CONTINUOUS TRACK OUTAGE (ONE WEEKEND ONLY)

**SOUTH STAMFORD ACCESSIBILITY
& MNRR BRIDGE REPLACEMENT
FEASIBILITY STUDY**

**ATLANTIC STREET, ELM STREET
& EAST MAIN STREET
CONSTRUCTION STAGING**

STAGE 7A

URS	SCALE: N.T.S.	FIGURE 2.1i
------------	---------------	-------------

LEGEND:

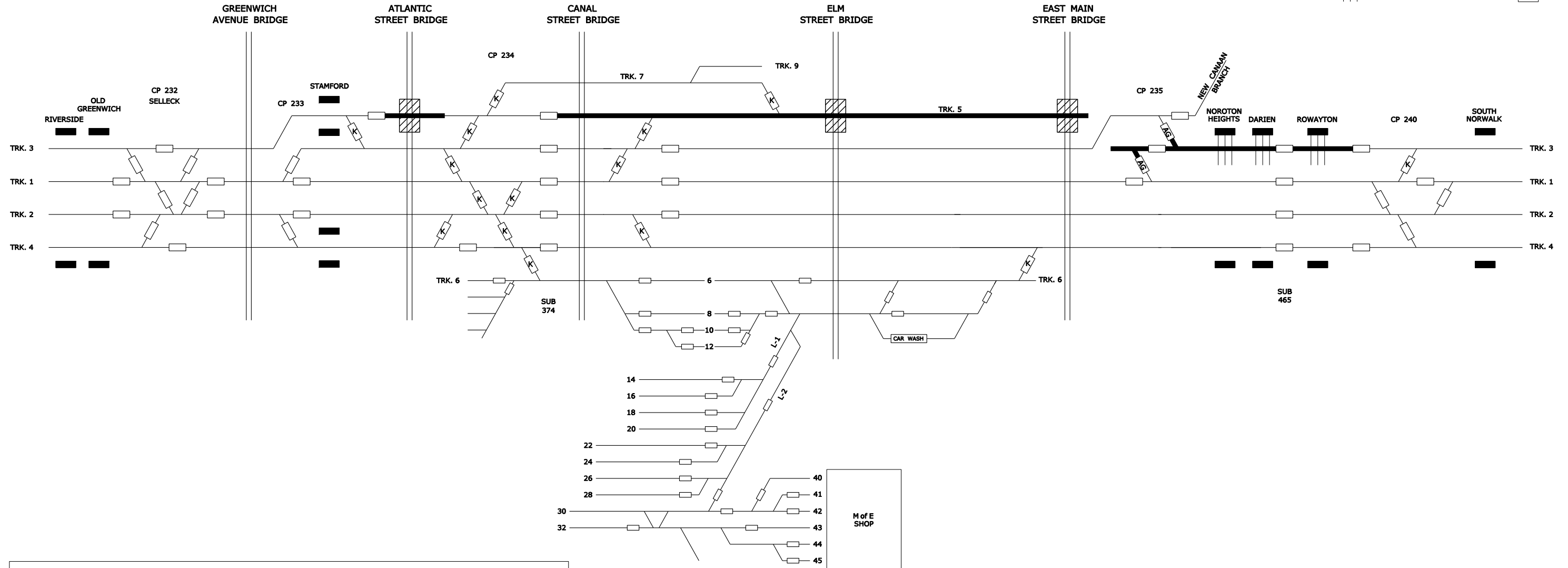
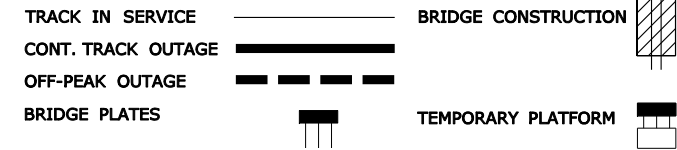

STAGE	TASK	TRACK	TRACK OUTAGE
7B	1) REMOVE TRACK 5 AT ATLANTIC ST. REMOVE TRACK 5 AT ELM ST. REMOVE TRACK 5 AT EAST MAIN ST. 2) REMOVE EXISTING STEEL SUPERSTRUCTURE 3) INSTALL NEW ABUTMENTS 4) INSTALL NEW CENTER PIER 5) CUT BACK TOPS OF EXISTING ABUTMENTS 6) INSTALL NEW SUPERSTRUCTURE 7) INSTALL NEW TRACK 5 AT ATLANTIC ST. INSTALL NEW TRACK 5 AT ELM ST. INSTALL NEW TRACK 5 AT EAST MAIN ST.	5,3	CONTINUOUS TRACK OUTAGE

**SOUTH STAMFORD ACCESSIBILITY
& MNRR BRIDGE REPLACEMENT
FEASIBILITY STUDY**

**ATLANTIC STREET, ELM STREET
& EAST MAIN STREET
CONSTRUCTION STAGING**

STAGE 7B

URS	SCALE: N.T.S.	FIGURE 2.1j
------------	---------------	-------------

LEGEND:

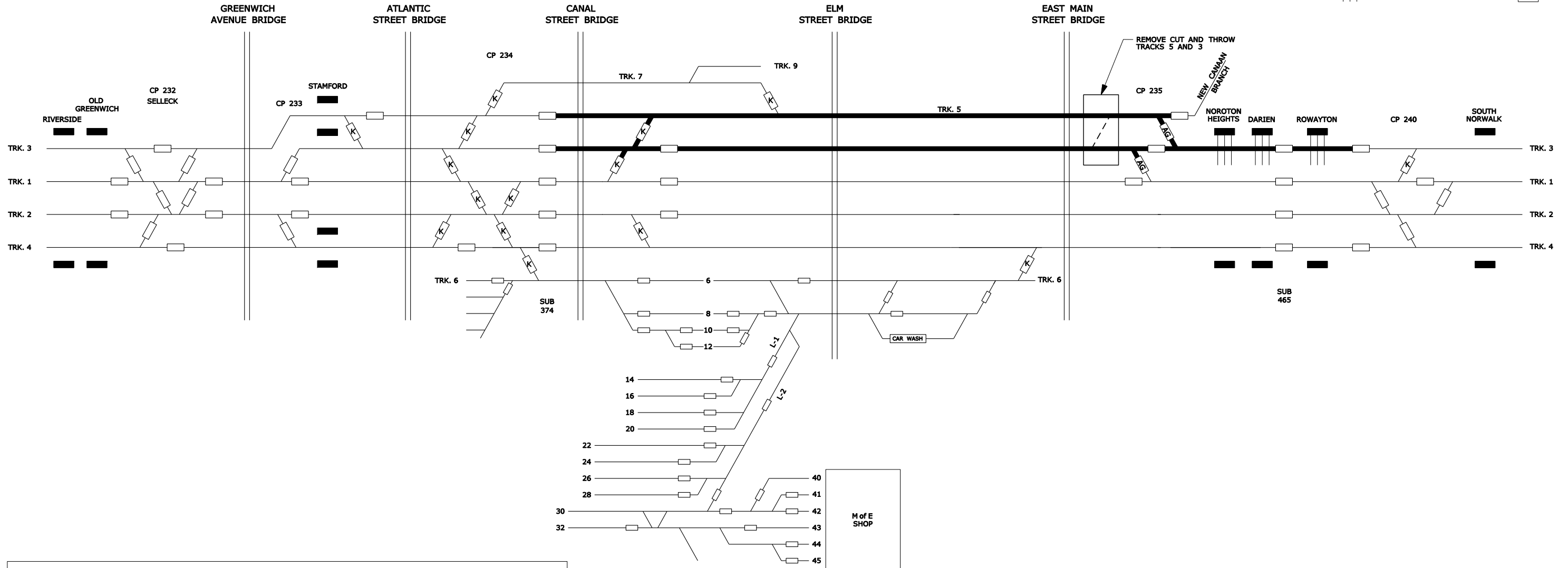
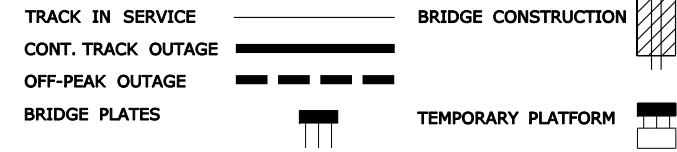

STAGE	TASK	TRACK	TRACK OUTAGE
7C	1) REMOVE CUT AND THROW TRACKS 5 AND 3	5,3	CONTINUOUS TRACK OUTAGE (ONE WEEKEND ONLY)
	2) REMOVE BRIDGE PLATES AT NORTON HEIGHTS DARIEN, ROWAYTON.	3	OFF PEAK WEEKEND NIGHT OUTAGE

**SOUTH STAMFORD ACCESSIBILITY
& MNRR BRIDGE REPLACEMENT
FEASIBILITY STUDY**

**ATLANTIC STREET, ELM STREET
& EAST MAIN STREET
CONSTRUCTION STAGING**

STAGE 7C

URS	SCALE: N.T.S.	FIGURE 2.1k
------------	---------------	-------------

MAINTENANCE AND PROTECTION OF TRAFFIC

- CLOSE ROADWAY TO TRAFFIC FOR DURATION OF CONSTRUCTION.
- MAINTAIN PEDESTRIAN ACCESS ON A MINIMUM OF ONE SIDEWALK FOR DURATION OF CONSTRUCTION.

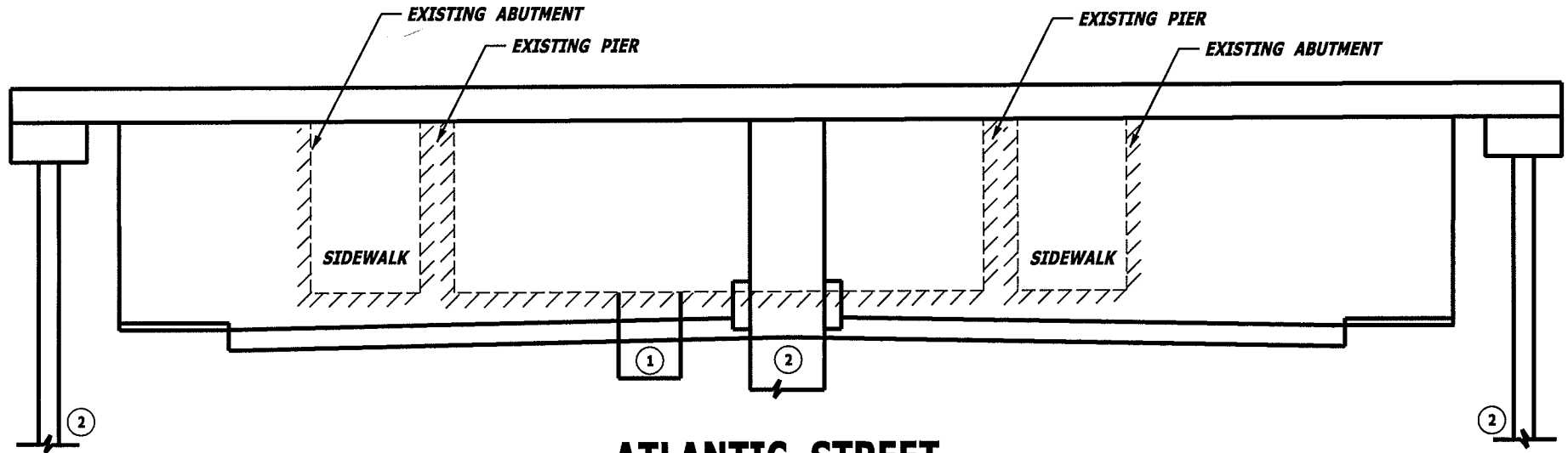

ATLANTIC STREET LOOKING NORTHBOUND

CONSTRUCTION STAGING

1. RELOCATE UTILITIES AS REQUIRED.
2. CONSTRUCT ABUTMENTS AND PIERS.
3. DEMOLISH EXISTING ABUTMENTS AND PIERS.
4. RECONSTRUCT ROADWAY.

**METRO NORTH RAILROAD
BRIDGE REPLACEMENT
FEASIBILITY STUDY**

**ATLANTIC STREET
ROADWAY MPT**

URS

SCALE: 1"=12'

FIGURE 3.1a

MAINTENANCE AND PROTECTION OF TRAFFIC

- MAINTAIN ONE LANE OF TRAFFIC IN EACH DIRECTION.
- MAINTAIN PEDESTRIAN ACCESS ON SIDEWALK ALONG WEST ABUTMENT AND CLOSE SIDEWALK ALONG EAST ABUTMENT TO PEDESTRIAN TRAFFIC.

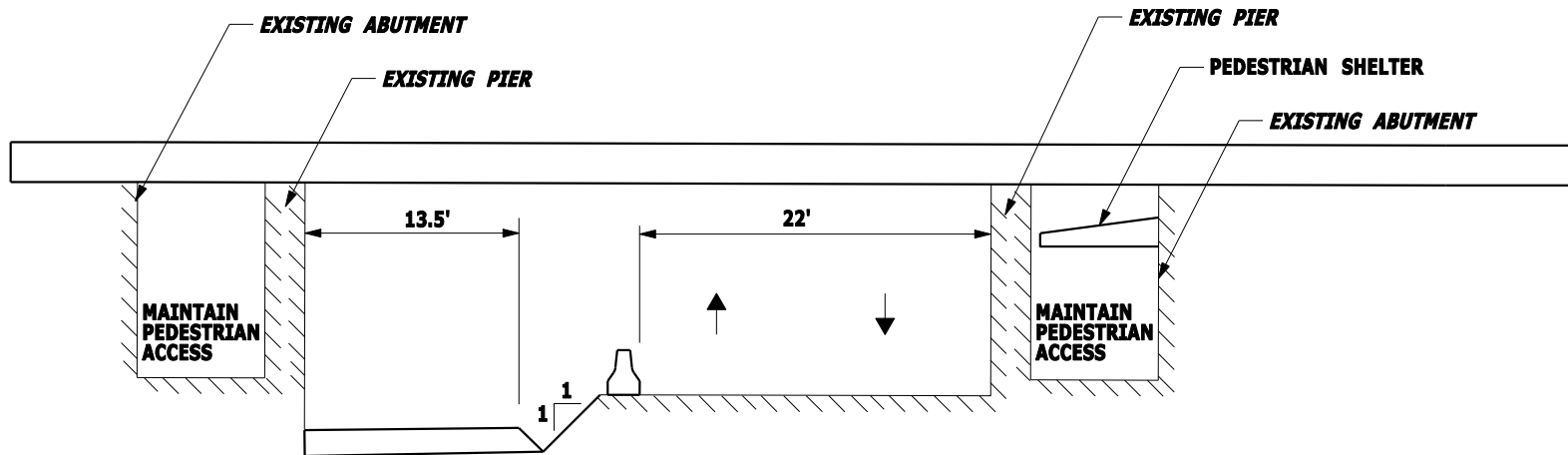

**EAST MAIN STREET
LOOKING EAST (NORTHBOUND)**

CONSTRUCTION STAGING

1. INSTALL PEDESTRIAN SHELTER.
2. RELOCATE UTILITIES AS REQUIRED.
3. REMOVE EXISTING PAVEMENT AND LOWER ROADWAY.

SOUTH STAMFORD ACCESSIBILITY
& MNRR BRIDGE REPLACEMENT
FEASIBILITY STUDY

EAST MAIN STREET
ROADWAY MPT - STAGE 1A

URS

SCALE: 1"=12'

FIGURE 3.1b

MAINTENANCE AND PROTECTION OF TRAFFIC

- MAINTAIN ONE LANE OF TRAFFIC IN EACH DIRECTION.
- MAINTAIN PEDESTRIAN ACCESS ON SIDEWALK ALONG WEST ABUTMENT AND CLOSE SIDEWALK ALONG EAST ABUTMENT TO PEDESTRIAN TRAFFIC.

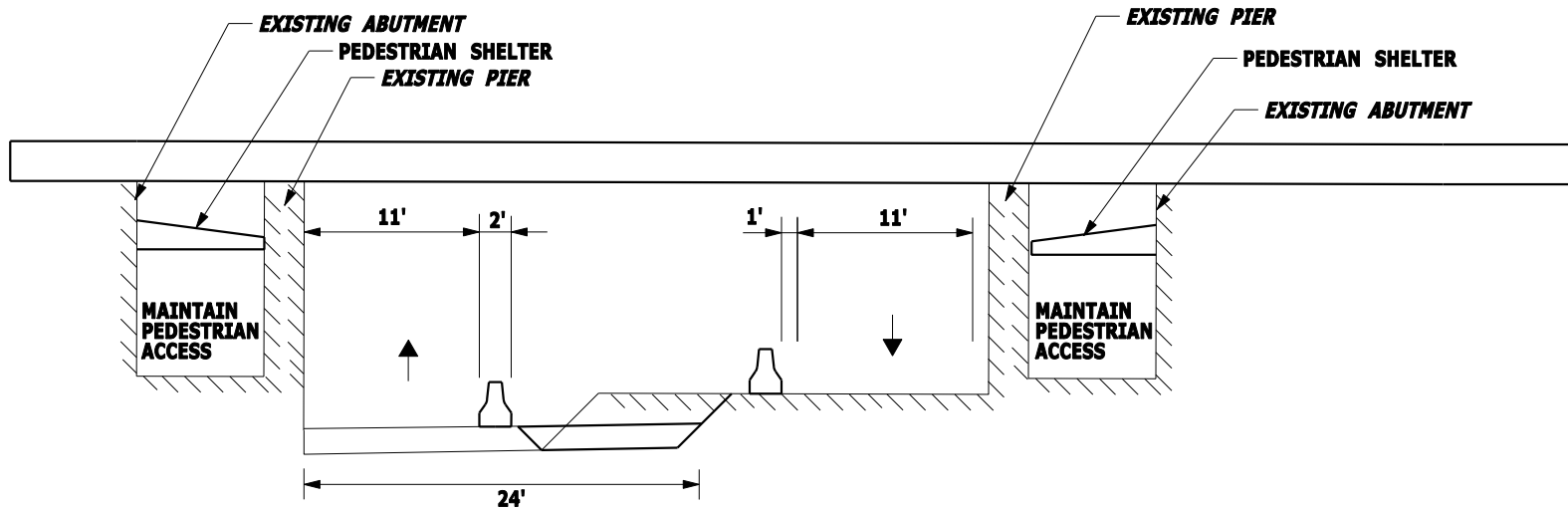

**EAST MAIN STREET
LOOKING EAST (NORTHBOUND)**

CONSTRUCTION STAGING

1. INSTALL PEDESTRIAN SHELTER.
2. RELOCATE UTILITIES AS REQUIRED.

SOUTH STAMFORD ACCESSIBILITY
& MNRR BRIDGE REPLACEMENT
FEASIBILITY STUDY

EAST MAIN STREET
ROADWAY MPT - STAGE 1B

URS

SCALE: 1"=12'

FIGURE 3.1c

MAINTENANCE AND PROTECTION OF TRAFFIC

- MAINTAIN ONE LANE OF TRAFFIC IN EACH DIRECTION DURING CONSTRUCTION OF ABUTMENTS AND PIERS.
- MAINTAIN PEDESTRIAN ACCESS ON SIDEWALK ALONG WEST ABUTMENT AND CLOSE SIDEWALK ALONG EAST ABUTMENT TO PEDESTRIAN TRAFFIC.
- CLOSE ROADWAY TO TRAFFIC TO INSTALL GIRDERS DURING WEEKEND PERIODS.

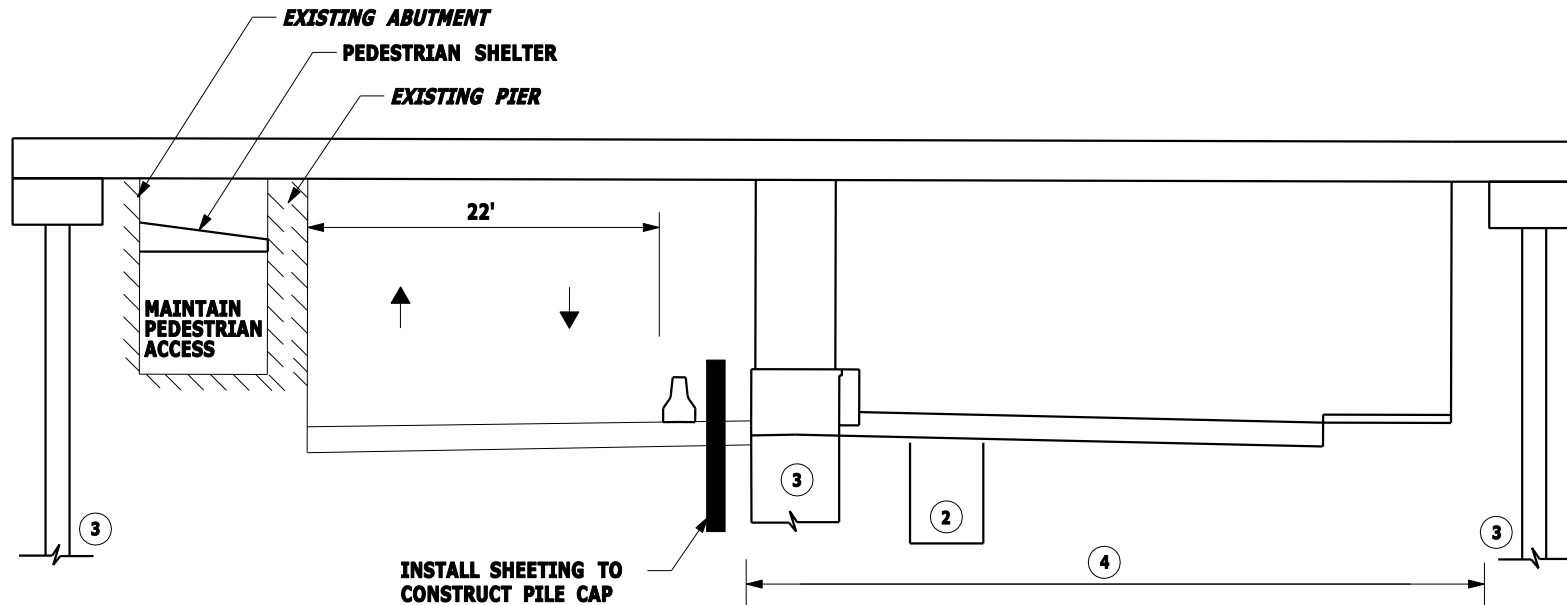

EAST MAIN STREET LOOKING EAST (NORTHBOUND)

CONSTRUCTION STAGING

1. INSTALL PEDESTRIAN SHELTER.
2. RELOCATE UTILITIES AS REQUIRED.
3. CONSTRUCT ABUTMENTS AND PIERS.
4. DEMOLISH EXISTING WEST ABUTMENT AND RECONSTRUCT ROADWAY AND SIDEWALK BETWEEN WEST ABUTMENT AND PIER.

SOUTH STAMFORD ACCESSIBILITY
& MNRR BRIDGE REPLACEMENT
FEASIBILITY STUDY

EAST MAIN STREET
ROADWAY MPT - STAGE 1C

URS

SCALE: 1"=12'

FIGURE 3.1d

MAINTENANCE AND PROTECTION OF TRAFFIC

- MAINTAIN ONE LANE OF TRAFFIC IN EACH DIRECTION DURING CONSTRUCTION OF ABUTMENTS AND PIERS.
- MAINTAIN PEDESTRIAN ACCESS ON SIDEWALK ALONG EAST ABUTMENT AND CLOSE SIDEWALK ALONG WEST ABUTMENT TO PEDESTRIAN TRAFFIC.
- CLOSE ROADWAY TO TRAFFIC TO INSTALL GIRDERS DURING WEEKEND PERIODS.

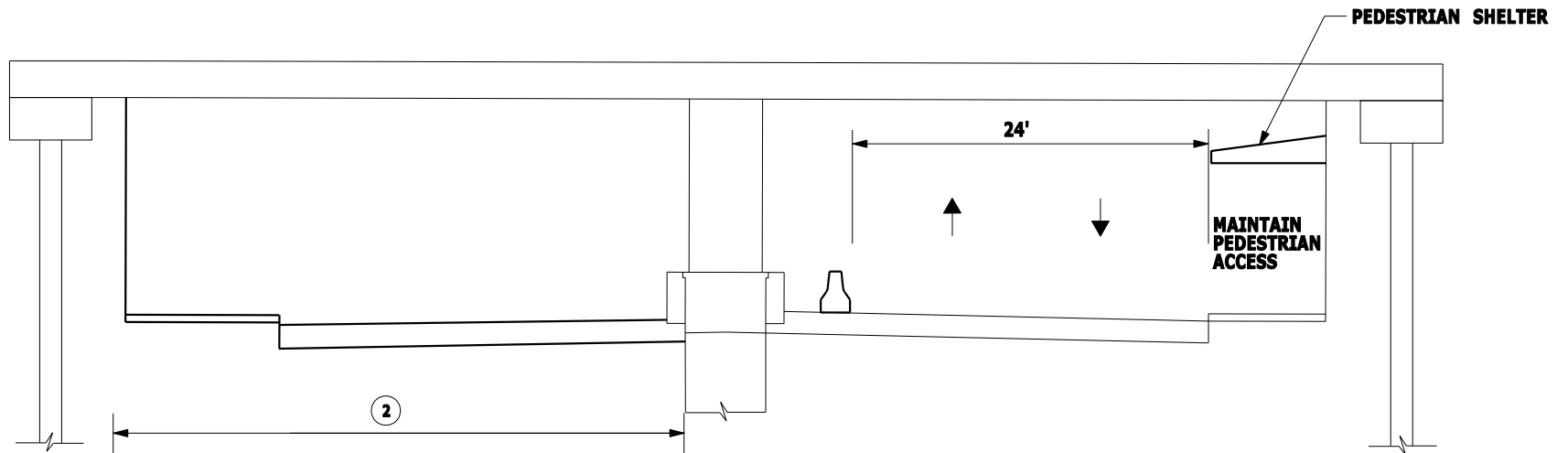

EAST MAIN STREET LOOKING EAST (NORTHBOUND)

CONSTRUCTION STAGING

1. INSTALL PEDESTRIAN SHELTER.
2. DEMOLISH EXISTING EAST ABUTMENT AND RECONSTRUCT ROADWAY AND SIDEWALK BETWEEN EAST ABUTMENT AND PIER.

SOUTH STAMFORD ACCESSIBILITY
& MNRR BRIDGE REPLACEMENT
FEASIBILITY STUDY

EAST MAIN STREET
ROADWAY MPT - STAGE 2

URS

SCALE: 1"=12'

FIGURE 3.1e

MAINTENANCE AND PROTECTION OF TRAFFIC

- MAINTAIN ONE LANE OF TRAFFIC DURING CONSTRUCTION OF ABUTMENTS AND PIERS.
- MAINTAIN PEDESTRIAN ACCESS ON SIDEWALK ALONG WEST ABUTMENT AND CLOSE SIDEWALK ALONG EAST ABUTMENT TO PEDESTRIAN TRAFFIC.
- CLOSE ROADWAY TO TRAFFIC TO INSTALL GIRDERS DURING WEEKEND PERIODS.

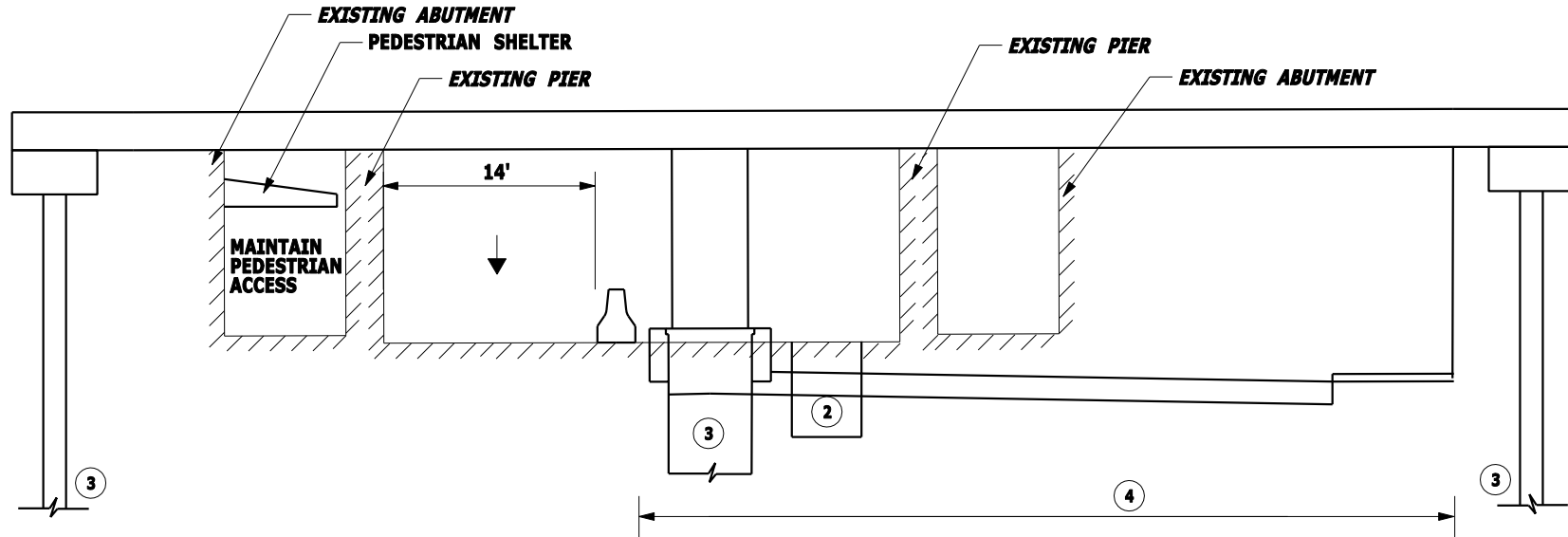

ELM STREET LOOKING NORTHBOUND

CONSTRUCTION STAGING

1. INSTALL PEDESTRIAN SHELTER.
2. RELOCATE UTILITIES AS REQUIRED.
3. CONSTRUCT ABUTMENTS AND PIERS.
4. DEMOLISH EXISTING EAST ABUTMENT AND RECONSTRUCT ROADWAY AND SIDEWALK BETWEEN EAST ABUTMENT AND PIER.

SOUTH STAMFORD ACCESSIBILITY
& MNRR BRIDGE REPLACEMENT
FEASIBILITY STUDY

ELM STREET
ROADWAY MPT - STAGE 1

URS

SCALE: 1"=12'

FIGURE 3.1f

MAINTENANCE AND PROTECTION OF TRAFFIC

- MAINTAIN ONE LANE OF TRAFFIC IN SOUTHBOUND DIRECTION AND TWO LANES IN NORTHBOUND DIRECTION DURING CONSTRUCTION OF ROADWAY AND SIDEWALK.
- MAINTAIN PEDESTRIAN ACCESS ON RECONSTRUCTED SIDEWALK ALONG EAST ABUTMENT AND CLOSE SIDEWALK ALONG WEST ABUTMENT.

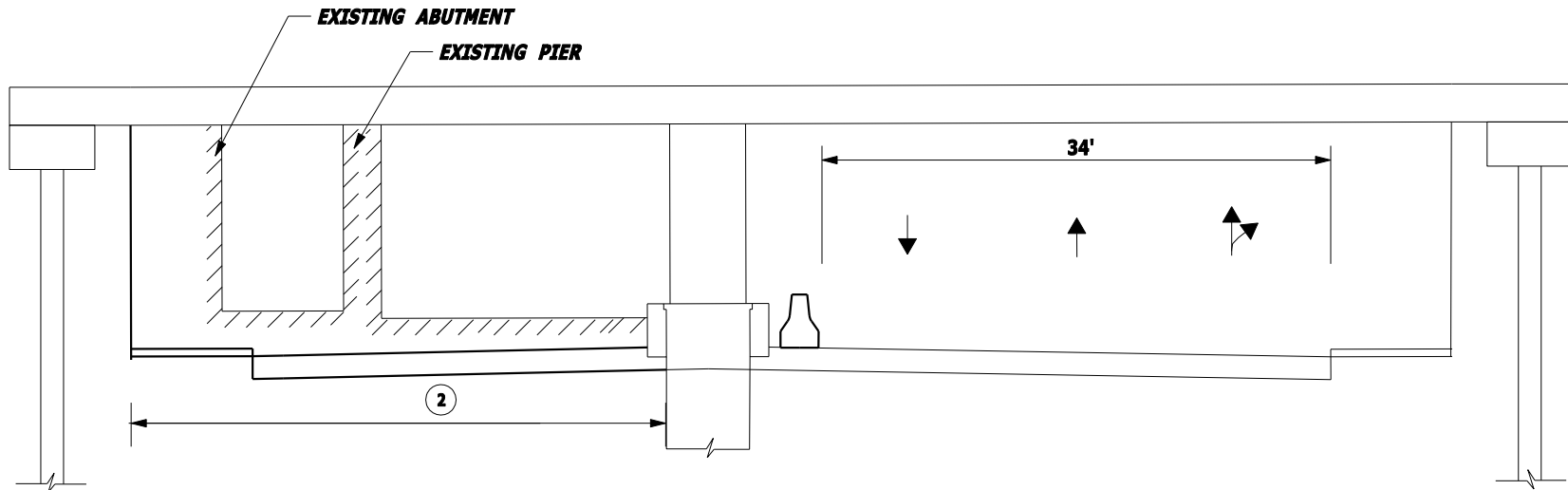

ELM STREET LOOKING NORTHBOUND

CONSTRUCTION STAGING

1. DEMOLISH EXISTING WEST ABUTMENT AND RECONSTRUCT ROADWAY AND SIDEWALK BETWEEN WEST ABUTMENT AND PIER.

**SOUTH STAMFORD ACCESSIBILITY
& MNRR BRIDGE REPLACEMENT
FEASIBILITY STUDY**

**ELM STREET
ROADWAY MPT - STAGE 2**

URS

SCALE: 1"=12'

FIGURE 3.1g