

SOUTH STAMFORD ACCESSIBILITY & MNRR BRIDGE REPLACEMENT FEASIBILITY STUDY

State Project No. 135-301
Stamford, Connecticut

PRELIMINARY ENGINEERING REPORT

Volume 5 of 7

ELM STREET - *DRAFT*

April 01, 2011

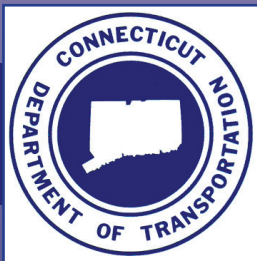

State of Connecticut
Department of Transportation

URS

500 Enterprise Dr, Ste 3B
Rocky Hill, CT 06067
Tel.: (860) 529-8882
Fax: (860) 529-3991
www.urscorp.com

TABLE OF CONTENTS – ELM STREET

| | |
|--|----|
| 1. INTRODUCTION | 1 |
| 1.1 Site Location and Description | 1 |
| 1.2 Site Features | 1 |
| 1.3 Proposed Improvements | 2 |
| 2. HIGHWAY DESIGN | 2 |
| 2.1 Horizontal Alignments and Lane Arrangements | 2 |
| 2.2 Vertical Profiles | 3 |
| 2.3 Rights-of-Way | 3 |
| 2.4 Identification of Substandard Conditions | 3 |
| 3. RAIL OPERATIONS | 4 |
| 3.1 Rail Staging and Sequencing Requirements | 4 |
| 3.2 Impact and Operational Issues of Proposed Construction | 5 |
| 3.3 Summary and Conclusions | 7 |
| 4. BRIDGE 03686R – MNRR OVER ELM STREET | 8 |
| 4.1 Existing Bridge | 8 |
| 4.2 Proposed Improvements | 8 |
| 4.2.1 Critical Controls | 8 |
| 4.2.2 Superstructure Types | 9 |
| 4.2.3 Abutments | 10 |
| 4.2.4 Pier | 11 |
| 4.2.5 Retaining Walls | 12 |
| 4.2.5.1 Roadway Retaining Walls | 12 |
| 4.2.5.2 Railroad Retaining Walls | 12 |
| 4.3 Phased Construction Requirements | 12 |
| 4.3.1 Suggested Superstructure Erection Method | 13 |
| 4.4 Aesthetic Treatments | 13 |
| 4.5 Summary and Conclusions | 13 |
| 4.5.1 Structure Summary | 13 |
| 4.5.2 Construction Duration | 14 |
| 4.5.3 Estimated Construction Cost | 14 |
| 5. OTHER STRUCTURES | 15 |
| 6. TRAFFIC | 15 |
| 6.1 Traffic Operational Requirements | 15 |
| 6.2 M&PT Requirements | 16 |
| 7. DRAINAGE | 17 |
| 7.1 Existing System Conditions | 17 |
| 7.2 System Constraints and Concepts Considered | 17 |
| 7.3 Design Criteria | 18 |
| 7.4 Design Documentation | 18 |

| | |
|--|----|
| 7. DRAINAGE (continued) | |
| 7.4.1 Gutter Flow | 19 |
| 7.4.2 Pipe Flow | 19 |
| 7.4.3 Hydraulic Grade Line | 19 |
| 7.5 Summary of Impacts and Proposed Improvements | 20 |
| 8. UTILITIES | 20 |
| 9. GEOTECHNICAL | 20 |
| 9.1 Summary of Subsurface Data | 20 |
| 9.1.1. Regional Geology | 20 |
| 9.1.2. Pilot Borings | 20 |
| 9.1.3. Subsurface Conditions | 21 |
| 9.1.4. Soil | 21 |
| 9.1.5. Groundwater | 21 |
| 9.2 Geotechnical Construction Issues | 21 |
| 9.3 Foundation Recommendations | 22 |
| 10. ENVIRONMENTAL | 22 |
| 10.1 Required Environmental Permits | 22 |
| 11. SUMMARY AND CONCLUSION | 23 |

APPENDIX

| | |
|--|----|
| Appendix A – Highway Design Criteria | 24 |
| Appendix B – Bridge Design Criteria | 25 |
| Appendix C – Construction Schedule | 27 |
| Appendix D – Construction Cost Estimates | 29 |
| Appendix E – Drainage Calculations | 32 |
| Appendix F – Boring Logs | 37 |
| Appendix G – Figures | 42 |

LIST OF FIGURES

Highway

- Figure 2.1 – Project Area
- Figure 2.2 – Roadway Plan
- Figure 2.3a-b – Roadway Profiles
- Figure 2.4 – Roadway Cross Section

Rail Operations

- Figure 3.1a-3.1i – Rail Staging and Sequencing Plans for Bridge 03686R

Bridge 03686R

- Figure 4.1 – General Plan & Elevation

LIST OF FIGURES (continued)

Bridge 03686R (continued)

- Figure 4.2 – Typical Sections
- Figure 4.3a-d – Construction Staging Sections
- Figure 4.4 – Abutment
- Figure 4.5 – Pier

Traffic

- Figure 6.1a-b – Maintenance and Protection of Traffic

Drainage

- Figure 7.1 – Drainage Plan

Utilities

- Figure 8.1 – Utility Plan

Geotechnical

- Figure 9.1 – Boring Plan

Environmental

- Figure 10.1 – 100 Year FEMA Floodplain

1. INTRODUCTION

1.1. Site Location and Description

The Metro-North Railroad (MNRR) undergrade¹ bridge is located at mile post 33.75 on the New Haven Line and crosses over Elm Street in the City of Stamford. The bridge carries seven MNRR mainline tracks. Immediately north of the bridge, Elm Street intersects with South State Street and the Interstate 95 (I-95) northbound entrance ramp. The Elm Street/South State Street intersection is state-assigned intersection 135-270. I-95 is located approximately 300 feet north of the MNRR tracks at this location. Approximately 300 feet south of the bridge, Elm Street intersects with Cherry Street and Elm Court, the proposed Stamford Urban Transitway (SUT). Please refer to Figure 2.1, located in Appendix G, for an overview of the project area.

1.2. Site Features

The underpass at Elm Street is currently an undivided road with two 12-foot lanes traveling in the northbound direction and one 12-foot lane traveling in the southbound direction. There are no shoulders, resulting in a curb-to-curb width of 36 feet. The existing sidewalks vary from 8 to 10 feet and are separated from the roadway by bridge columns.

North of the underpass, Elm Street intersects with South State Street and the I-95 northbound entrance ramp at a five-legged, signalized intersection. There is a crosswalk provided as South State Street approaches Elm Street. North from this intersection, Elm Street widens to three travel lanes in each direction. At the five-legged intersection, South State Street approaches Elm Street from the west with three 12-foot wide lanes and no shoulders at an approximate downgrade of 3.0%. South State Street continues east of Elm Street with two lanes totaling a 36-foot width and an upward grade of approximately 5.0%. The I-95 northbound entrance ramp also follows an upgrade of approximately 5.0%.

The horizontal alignment for Elm Street includes an approximate one-degree angle point, located at the intersection with South State Street. The vertical alignment is relatively flat at the Elm Street underpass. There is a posted minimum vertical clearance of 12'-6" and a measured vertical clearance of 12'-9". The existing intersection sight distance (ISD) for the Elm Street approach to South State Street is approximately 320 feet which corresponds to a design speed of 27+/- mph for a passenger car design vehicle.

The southwestern corner of the bridge has three small buildings alongside Elm Street. These are located on a parcel owned by MNRR. The southeastern corner of the bridge is a commercial plaza bound by Elm Street to the west and by a regional transportation facility to the east.

¹ An "Undergrade Bridge," in rail terms, refers to a road going under the grade of the railroad or under the track. In this case, the bridge acts to carry the tracks over Elm Street resulting in an undergrade bridges.

1.3. Proposed Improvements

The widening of Elm Street will allow for the addition of two travel lanes; one through lane in the southbound direction and one right-turn only lane in the northbound direction. These lanes will assist in providing the additional capacity needed to permit movement of cars north and south of the tracks. Additional improvements include two-foot shoulders and a median to divide opposing traffic. The reconstruction of the MNRR undergrade bridge will support the roadway widening and will provide an increased vertical clearance to permit the passing of all legal height vehicles. The largest vehicles owned and operated by the City of Stamford include a HazMat truck and the Police Department's command vehicle. Both of these vehicles have a height of 12'-6" which is the current posted vertical clearance.

The proposed work includes the total reconstruction of the superstructure and substructure of the undergrade bridge. The deck type proposed for the bridge is the MNRR preferred ballasted deck as opposed to the open deck currently in place.

2. HIGHWAY DESIGN

2.1. Horizontal Alignments and Lane Arrangements

The proposed lane arrangements for Elm Street are based on discussions with the Connecticut Department of Transportation (CTDOT) and the City of Stamford. Please refer to Figure 2.4, located in Appendix G for the proposed Elm Street cross section and Figure 2.5, Critical Cross Sections. The proposed lane arrangements include:

- three 11-foot lanes in the northbound direction
- two 11-foot lanes in the southbound direction
- 2-foot shoulders; inside and outside
- an 8-foot median which will also accommodate a bridge pier
- 8-foot wide sidewalks

The Elm Street curb-to-curb roadway width will total 71 feet at the undergrade bridge.

The proposed horizontal alignment for the Elm Street underpass will match the existing layout with a 600-foot radius at the inside edge of the travelway on the south side of the bridge. Please refer to Figure 2.2 for the Plan View of Elm Street, located in Appendix G. The South State Street intersection with Elm Street provides for an intersection sight distance (ISD) of 250 feet. This distance corresponds to a design speed of 23+/-mph for a passenger car design vehicle which does not meet the design criteria for a posted speed of 30 mph. Designing the intersection to provide for the required ISD will significantly impact the urban roadway, therefore a design exception will be required.

The northbound lanes will increase to three 11-foot lanes as Elm Street approaches South State Street (the additional lane provided will be a right-turn only lane onto South State Street). The proposed horizontal alignment and lane arrangements for Elm Street south of the bridge will match the SUT, currently under construction.

A clearzone distance of 14 feet is required for design speeds of 40 mph or less. The available clearzone at Elm Street is approximately 10 feet. Because this does not meet the criteria for a design speed of 40 mph, a design exception will be required.

2.2. Vertical Profiles

The vertical geometry of Elm Street at the underpass is determined by the depth of the proposed Metro-North bridge. A minimum vertical clearance of 14'-6" from road elevation to bottom of structure is required. To provide the required minimum clearance, the vertical profile for Elm Street has to be lowered by approximately 2.6 feet with a 120-foot sag vertical curve and a maximum grade of 3.5%. Please refer to Figure 2.3a, located in Appendix G, for the proposed Elm Street profile and Figure 2.3b for the proposed South State Street profile.

The stopping sight distance (SSD) is provided based on an illuminated highway and is greater than 305 feet. A 305-foot SSD provides for a design speed greater than 40 mph. South State Street on the east approach to the intersection meets Elm Street at a grade of 8.6%.

2.3. Rights-of-Way

Three small buildings which are part of the MNRR facility will need to be demolished as part of the undergrade bridge reconstruction. In addition to the MNRR properties, two commercial properties along the east side of Elm Street between Court Street and the bridge will require partial property acquisitions. Also, rights-of-way will be required to construct the sidewalk along Elm Street in front of the Elm Street Market and Dunkin Donuts.

2.4. Exceptions to Geometric Design Criteria

Since the ISD does not meet the criteria for a design speed of 30 mph, a design exception will be required. The clearzone also does not meet the design criteria and will also require a design exception.

3. RAIL OPERATIONS

3.1. Rail Staging and Sequence Requirements

The Elm Street bridge is an undergrade structure on the New Haven Line at mile post (MP) 33.75 in Stamford, Connecticut. The bridge is situated between CP234 and CP235. CP234 and CP235 are interlockings². The "CP" signifies Control Point, the "2" indicates that the interlockings are located on the New Haven Line, and the last two digits indicate approximate mile posts.

² Interlockings are switches and/or crossovers that allow trains to travel from one track to another governed by signal indications. On the New Haven line, these points are remotely controlled by the MNRR Operations Control Center.

The Elm Street bridge is located approximately 0.75 miles east of the Stamford Intermodal Transportation Center (SITC). The bridge carries seven tracks: the New Canaan Branch (Track 5), four New Haven Line tracks, numbered 3, 1, 2, and 4, Yard Lead Track 6, and Yard Track 8. Replacement of the bridge will be done one track at a time. The replacement work will require that each track be taken out of service while the reconstruction work on the portion of the bridge under that track is performed. The bridge replacement work can be done either working in the north to south, or the south to north direction.

The construction staging plans for Elm Street bridge show the reconstruction of the bridge being progressed in a north to south direction (Track 5 to Track 8). Please refer to Appendix C for the Construction Schedule. The bridge reconstruction work is shown being done in seven main stages. Each of these stages will require a continuous track outage for the track being replaced on that portion of the bridge. It is estimated that the duration of the continuous track outage required for reconstruction will be 150 calendar days per track.

The continuous track outages will not impact the use of the SITC passenger platforms. During these outages however, the normal routing of westbound trains into the station area will have to be adjusted to accommodate the out-of-service tracks on the Elm Street bridge.

The installation of a temporary track cut-and-throw between Tracks 5 and 3 will be required during Stage 1 of the project work. This track cut-and-throw will allow the continuous operation of the New Canaan Branch trains during the replacement of Track 5 on the Elm Street bridge. Two additional short track outage periods will be required during this stage for the installation and removal of the temporary track throw.

During Stage 1 and Stage 5 of the project work, bridge plates at the Noroton Heights, Darien, and Rowayton Stations will be required. Bridge plates will be required with the Track 3 continuous outage in Stage 1 and the Track 4 continuous outage in Stage 5 as these outages extend east through these three stations.

During the Stage 7 work, Track 8 on the Elm Street bridge will be out of service. This track outage will impact train operations and access into yard Tracks 6, 8, 10, 12, the Lower Stamford Yard, and the Maintenance of Equipment facility.

With the mobilization period, the 150 calendar days required for each continuous track outage, and the approximate 5 month period to complete the roadway work under the bridge, the total project duration time for the replacement of the Elm Street bridge is approximately 3 years, 10 months.

3.2. Impact and Operational Issues of Proposed Construction

At the Elm Street bridge, there will be two critical impacts to Metro-North train operations. One is when Track 5 is reconstructed across the bridge, and the second is when Track 8 is reconstructed.

When Track 5 is removed during the replacement of that portion of the Elm Street bridge, the New Canaan Branch will be taken out of service and normal train service for the branch line will not run. Busing service for the New Canaan Branch commuters was considered but deemed impractical. After review by CTDOT and Metro-North, it was determined that a temporary Track 3-5 cut-and-throw be installed between Tracks 5 and 3, just east of the East Main Street bridge.

This temporary track realignment will allow the New Canaan Branch trains to be operated during the Track 5 bridge reconstruction at Elm Street. Minor track outages and limited weekend busing may be required during the installation and the removal of the track cut-and-throw.

During the replacement of Track 8 on the Elm Street bridge, the lead tracks into Stamford Lower Yard will be taken out of service at the bridge. This will prevent train access into and out of the Lower Yard and the Stamford Maintenance of Equipment facility. This does not appear to be an area where a temporary crossover or track throw can be utilized to allow access and train movements to the Lower Yard. This part of the bridge construction will have a critical impact to Metro-North train operations.

Additional discussions will be required with CTDOT and Metro-North to determine the options available for maintaining, or temporarily moving train operations in this area during the reconstruction of Track 8 at Elm Street.

Replacement of Track 5 (New Canaan Branch) - When Track 5 at the Elm Street bridge is taken out of service, the installation of a temporary cut-and-throw between Tracks 5 and 3 will be required. This temporary track realignment will allow operation of the New Canaan Branch train service during the Track 5 reconstruction work. Please refer to Figure 3.1a for Stage 1A of the construction staging.

During this stage of the work, bridge plates will be required at the Noroton Heights, Darien, and Rowayton Stations.

When Track 5 at the Elm Street bridge is taken out of service, eastbound trains on Track 5 will use the 5-3 crossover in CP234 to divert to Track 3, and the Track 3-5 cut-and-throw to divert to Track 5 and continue on the New Canaan Branch. Please refer to Figure 3.1b for Stage 1B of the construction staging.

Westbound trains on Track 5 (New Canaan Branch) will use the Track 3-5 cut-and-throw to divert to Track 3, and the 5-3 crossover in CP234 to divert to the Track 5 passenger platform track at the SITC.

The Track 3-5 cut-and-throw will be removed, and the normal alignment of Tracks 5 and 3 will be restored when the track 5 bridge work is completed on the Elm Street bridge. Please refer to Figure 3.1c for Stage 1C of the construction staging.

Replacement of Track 3 - When Track 3 at the Elm Street bridge is taken out of service, eastbound trains on Track 3 will use the crossovers in CP234 and CP235 to run around the Track 3 outage at the Elm Street bridge. Please refer to Figure 3.1d for Stage 2 of the construction staging.

Westbound trains on Track 3 will use the 5-3 crossover in CP235, and the crossovers in CP234 to run around the bridge work on Track 3.

Replacement of Track 1 - When Track 1 at the Elm Street bridge is taken out of service, eastbound trains on Track 1 will use the crossovers in CP234 and CP235 to run around the bridge work on Track 1. Please refer to Figure 3.1e for Stage 3 of the construction staging.

Westbound trains on Track 1 will use the 3-1 crossover in CP235, and the crossovers in CP234 to run around the Track 1 outage at the Elm Street bridge.

Replacement of Track 2 - When Track 2 at the Elm Street bridge is taken out of service, eastbound trains on Track 2 will use the crossovers in CP234 to divert to one of the adjacent in-service tracks to run around the bridge work on Track 2. Please refer to Figure 3.1f for Stage 4 of the construction staging.

Westbound trains on Track 2 will use the crossovers in CP240 and CP241 to divert from Track 2 to an adjacent in-service track to run around the Track 2 outage at the Elm Street bridge.

Replacement of Track 4 - When Track 4 is taken out of service at the Elm Street bridge, bridge plates will be required at the Noroton Heights, Darien, and Rowayton passenger stations. Please refer to Figure 3.1g for Stage 5 of the construction staging.

Eastbound trains on Track 4 will use the crossovers in CP234 to divert to one of the adjacent in-service tracks to run around the bridge work on Track 4.

Westbound trains on Track 4 will use the crossovers in CP240 and CP241 to divert from Track 4 to an adjacent in-service track to run around the Track 4 outage at the Elm Street bridge.

Replacement of Yard Track 6 - When Track 6 is taken out of service at the Elm Street bridge, a section of yard Track 6 will be removed over the Elm Street bridge. Trains will be able to run around the bridge construction work on Track 6 by using Track 8, and the 6-8 and 8-6 crossovers on each side of the Elm Street bridge. Please refer to Figure 3.1h for Stage 6 of the construction staging.

Replacement of Yard Track 8 (Lower Yard Lead Tracks) - When Track 8 is taken out of service at the Elm Street bridge, the entrance to the Lower Stamford Yard will be blocked. Both yard lead Tracks L-1 and L-2 will be taken out of service. Please refer to Figure 3.1i for Stage 7 of the construction staging.

The yard lead tracks are critical tracks that are used by all trains that originate and terminate in Stamford. These yard lead tracks are also used as access to the Stamford Maintenance of Equipment facility. This is a major impact to Metro-North train operations.

It does not appear that these tracks can be reconfigured with the installation of a temporary crossover(s) and/or track throw to allow access and train movements to the yard lead tracks and into the Lower Stamford Yard. Other possible options will have to be considered and discussed with CTDOT and Metro-North.

3.3. Summary and Conclusions

Construction of the Elm Street bridge will impact train operations on the New Canaan Branch, in CP234, and access into the Lower Stamford Yard and the Stamford Maintenance of Equipment facility. The bridge reconstruction will also require the installation of a temporary Track 3-5 cut-and-throw for continued operation of the New Canaan Branch train service.

Further discussions with CTDOT and Metro-North are necessary to discuss and consider solutions for maintaining access to the Lower Stamford Yard when Track 8 is reconstructed.

Bridge construction will not substantially impact train operations on the SITC tracks. Bridge plates will be required at the Noroton Heights, Darien, and Rowayton passenger stations during different stages of the work.

It is recommended that this bridge be reconstructed at the same time as the East Main Street bridge. This is recommended because both of these bridges have the same train operation issues for the New Canaan Branch service when Track 5 is taken out of service on these bridges. Any solution to these train operation inconveniences could be shared between both bridges during a single construction sequencing period.

This bridge could also be considered for concurrent reconstruction with the Canal Street, Atlantic Street or Greenwich Avenue bridges. Metro-North should be consulted

for its concurrence regarding these recommendations, and to determine any other train operation impacts.

4. BRIDGE 03686R – MNRR OVER ELM STREET

4.1. Existing Bridge

The existing MNRR bridge is identified as Bridge No. 03686R at MNRR mile post (MP) 33.75. The bridge carries seven mainline tracks over Elm Street. Please refer to Figure 4.2 for the existing and proposed typical cross sections, located in Appendix G. The bridge has been rated for a Cooper E48.3 loading as its Normal Load Rating. The out-to-out width of the bridge is 96 feet and the interior span length is approximately 64 feet spanning over the roadway. The bridge has a posted vertical clearance of 12'-6" and a surveyed vertical clearance of 12'-9".

The three-span, open-deck superstructure is steel-framed and is made up of seven pairs of built-up girders; each pair of girders independently supporting a single track. The superstructure is supported by gravity-type abutments and wingwalls made up of stacked stone masonry and steel-framed piers. The wingwalls are flared parallel to the roadway and taper down with the embankment grading. The piers run parallel to the abutments and are supported by concrete pedestals.

In a bridge inspection report dated October of 2008, the bridge was found to be in poor condition with an overall rating of "4" out of "10". In the report, the superstructure was found to have many areas of varying degrees of deterioration including section loss, cracking, and damage from vehicular collision. The substructure was found to be in fair condition with some section loss and cracking on the steel piers.

4.2. Proposed Improvements

Proposed improvements include (please refer to Figure 4.1, located in Appendix G for the General Plan and Elevation of the proposed bridge):

1. Increasing the bridge span length to accommodate the wider curb-to-curb width of Elm Street.
2. Increasing the vertical clearance to accommodate all legal height vehicles.

4.2.1. Critical Controls

In order to accommodate the roadway widening, it is necessary to widen the bridge span length by setting the west and east bridge abutments back behind the existing abutments 9'-6" and 22'-6", respectively. This distance is measured along the centerline of MNRR Track 1 from the existing abutment face. Setting the abutments back increases the span length from approximately 65 feet to 105 feet.

To provide a shallower superstructure, the proposed bridge will consist of two simple spans, 45.7 feet and 57 feet, supported by two full height abutments and a pier located between the northbound and southbound traffic. The location of the

pier also serves to divide opposing traffic. The proposed pier layout conforms to the proposed horizontal roadway alignment. Lane delineations, curb locations, and abutments are offset from the centerline of the pier.

A requirement of Metro-North is that the elevation and horizontal alignment of the MNRR tracks remain unchanged. Since the tracks cannot be raised, the required minimum vertical clearance of 14'-6" in conjunction with the depth of proposed structure will control the vertical geometry of Elm Street. The final vertical profile of Elm Street will dictate the extent that Elm Street will need to be lowered and the degree this will impact adjacent intersections and roadways as well as adjacent properties.

In addition, overhead catenary wires will be de-energized but will be maintained in their current location during construction activities, restricting headroom. This constraint will limit the use of overhead equipment, e.g. cranes. This is of particular importance during construction of the foundations and erection of the superstructure.

4.2.2. Superstructure Types

Several bridge types were considered for the preliminary engineering study including:

- ballasted deck half-through girders
- 2-girder ballasted concrete deck
- multi-steel girder ballasted steel plate deck
- precast multi concrete-encased beams
- prestressed butted box beams

The controlling design span length is approximately 57 feet, controlled by Span 2 over the northbound travel lanes of Elm Street. The superstructure depth is measured from the top of track to the bottom of the girder. This includes common dimensions like $7\frac{5}{16}$ -inch rail height, 8½-inch concrete ties, 8½-inch minimum ballast thickness, and 1-inch ballast mat. Dimensions for a specific structure types include a 13-inch concrete deck with haunch for the two-girder option, 1½-inch steel deck plate for through-girder option, and 2-inch thick steel deck plate for the multi-steel girder option.

Half-Through Girders: This structure type allows the top of the girder to be above the deck but limited by the railroad clearance envelope. This permits a reduction in the superstructure depth, which is measured from the top of track to the bottom of the bottom flange. However, this may not be the case for short spans where the geometric configuration of the deck framing system would require larger superstructure depths than structurally required. Such is the case for the proposed Elm Street bridge, where a deeper through-girder superstructure depth is required in

comparison to the existing superstructure and the precast concrete-encased beam option.

Two-Girder Ballasted Concrete Deck: This superstructure type consists of two girders below a ballasted concrete deck. This is generally more economical compared to other superstructure types because it is the simplest to fabricate and to erect. One weakness of this structure type is that all girders are fracture critical. Additionally, it usually requires the greatest superstructure depth, adding to the amount Elm Street would have to be lowered in order to attain the required minimum vertical clearance. This option would require a 7'-4" superstructure depth at Elm Street.

Multi-Steel Girder Ballasted Steel Plate Deck: This framing system requires a shallower superstructure than a two-girder framing system. However, unlike the two-girder system, the multiple steel girders offer structural redundancy and are therefore not considered to be fracture critical. It is more economical to fabricate and to erect compared to a through girder system, but requires more maintenance throughout its design life. This steel superstructure requires a higher life-cycle cost than the precast multi concrete-encased beam alternative. This option would require a 5'-6" superstructure depth at Elm Street.

Precast Multi Concrete-Encased Beams: This superstructure type is economical and requires low maintenance. The butted beam construction allows for a ballasted track without the need to provide for an additional deck system. This structure type offers the shallowest superstructure depth among the alternatives considered, but usually requires the use of significantly more steel than the other alternatives. This system is appropriate for short to moderate span lengths. This alternative would require a 5'-0" superstructure depth at Elm Street.

Prestressed Butted Box Beams: Butted box beams are generally economical, easy to erect, and require low maintenance. Similar to the precast multi concrete-encased beams, they allow for a ballasted deck without the need to provide for an additional deck system. However, precast butted box beams offer limited superstructure depth options, generally requiring larger superstructure depths than the precast multi concrete-encased beams. For this reason, this alternative will not be considered in this study.

After consideration of the advantages and disadvantages of each superstructure type, the multi-steel girder and the precast multi concrete-encased beam structure types are the most viable alternatives for this application and therefore will be presented in this report.

4.2.3. Abutments

Because the bridge is being built in stages, it is proposed that the new abutments be constructed using a top-down construction technique. Please refer to Figure 4.4 for the Abutment Plan showing the top-down construction technique. This construction methodology allows for short stub abutments supported on mini-piles. Because this type of abutment and methodology requires less excavation and materials, controlled excavation can occur within close proximity to the adjacent, operating tracks. Drilled mini-piles are the recommended deep foundation for the abutments since they will allow ease of installation under low overhead conditions. The abutment seat will be constructed with cast-in-place concrete and the abutment wall will be built using a tie-back wall with steel walers, concrete lagging, and a concrete fascia aesthetically treated with concrete formliner.

Alternatively, conventional abutments may be used, which will reduce the span length and subsequently reduce the superstructure depth by approximately two to three inches. However, construction of conventional type abutments would require a significant amount of structure excavation adjacent to live tracks and an extensive temporary earth retaining system. Because of this, this type of abutment results in a longer construction duration. Roadway construction cost savings from the reduction of the superstructure depth is estimated to be minimal, and is not considered to be commensurate to the significant additional cost associated with this substructure construction.

4.2.4. Piers

Due to the increased length of the bridge and the need to provide a shallow superstructure, a two-span bridge is proposed. The two spans will be supported by the new abutments and a new proposed pier. This pier will also act as a divider between directional traffic. Please refer to Figure 4.5, located in Appendix G for the pier plan.

The proposed pier will be comprised of a footing, pier cap, and circular columns. The pier cap width is estimated to be 5'-6" in order to accommodate two rows of bearings. The circular columns are estimated to be 4-foot in diameter and will be supported on an 8-foot wide pile cap founded on mini-piles. Two-foot vertical traffic barriers will be placed on either side of the pier columns to protect the columns from vehicular collisions.

Elm Street will remain open to traffic during construction. Two stages of construction are required to rebuild Elm Street to the final condition and maintain traffic. During Stage 1, one lane of traffic will be open and could be designated for northbound traffic or southbound traffic exclusively, or reversed to flow in the peak hour traffic direction, or flagged for alternating one-way traffic during off-peak hours. In order to provide adequate room for maintenance of traffic and a work zone, a narrow pile cap will have to be utilized. For this reason, a spread footing is

not a viable option at this location because it will require a wider work zone. The narrower footing will be founded on drilled mini-piles. During Stage 2, one lane of traffic will be maintained.

4.2.5. Retaining Walls

4.2.5.1. Roadway Retaining Walls

Due to the lowering of Elm Street in order to obtain the required minimum vertical clearance, retaining walls will need to be reconstructed and/or reinforced.

On the southwestern corner of the bridge, the existing retaining wall along Elm Street supporting the MNRR property will have to be replaced with a taller retaining wall. No retaining wall is required beyond the existing wingwall at the southeastern corner of the bridge.

On the northern side of the bridge, the lowering of Elm Street will impact the five-legged intersection with South State Street and the I-95 entrance ramp. The existing cast-in-place retaining wall on the northern side of South State Street will need to be extended towards the intersection at South State Street both to the east and west of Elm Street.

4.2.5.2. Railroad Retaining Walls

The lowering of South State Street will require new, short retaining walls along the south side of South State Street to maintain the railroad embankment. The bridge's north wingwalls will adjoin these retaining walls.

4.3. Phased Construction

Because only one MNRR track can be taken out-of-service at a time, the construction of a new bridge must be done in phases. The new construction will be a top-down method to allow the foundations of the nearby operating track to remain stable. The tracks can be taken out of service in a north to south or a south to north order. As previously discussed in the rail operations section of this report, the tracks are shown as being taken out from north to south. Please refer to Figures 4.3A to 4.3D for the construction staging plans. These figures are located in Appendix G.

As a track is taken out of service, work will immediately begin to stabilize the foundation of the adjacent tracks to permit excavation under the track that is out. Once the earth retaining system is in place, construction of the new abutments will begin in a top-down method. At the same time, the existing pier will be demolished under the track that is out and the new pier will be constructed in its proposed location. The new superstructure will be supported by new substructure with the existing, independently functioning structure one track away. Once the new structure is completed, the next

adjacent track will be taken out of service. Again, care will be taken not to disturb the existing or new foundations.

Upon completion of the last track, the roadwork to realign the underpass roadway will begin its final stages. At this point, the existing abutments and the backfill between the existing and proposed abutment will be removed and excavated in conjunction with the top-down construction of the abutment tie-back walls.

4.3.1 Suggested Superstructure Erection Method

The conditions around the track present challenges for the erection procedure. Particular challenges include:

- obtaining the required vertical clearance
- horizontal clearances limited by adjacent live tracks
- maintenance of traffic
- overhead wires

A method of erection that is suited to these constraints is launching the girders on the out-of-service track. This involves the building of a beam erection frame on both the abutment and the pier at track level. These frames will support an erection beam that will span from pier to abutment and be capable of supporting at least one half the weight of a bridge beam. The bridge beam will be delivered to the site via rail car on the track that is out of service. One end of the bridge beam will be supported by rollers on the bottom flange of the erection beam while the other beam will be supported on land by another rolling mechanism. The bridge beam will be launched across the span and lowered to its permanent location. These steps will be repeated for all beams to complete the superstructure.

4.4. Aesthetic Treatments

The face of the concrete abutments will be aesthetically treated with concrete formliner to simulate a stone appearance and can be made to mimic the appearance of the original brownstone masonry.

4.5. Summary and Conclusions

4.5.1. Structure Summary

It is proposed that the existing three-span plate girder bridge be replaced as a two-span structure with one of the several proposed bridge types. A longer proposed span to accommodate additional travel lanes for the underpass will require the addition of a pier in order to minimize structure depth.

Five structure types were considered for feasibility. Non-viable types were eliminated and the remaining options were considered for their impact to Elm Street profile, constructability and cost.

One track will be taken out of service at a time, to mitigate impact to the rail operations. As a result, construction will progress in phases. Each phase will require a track outage where the existing bridge will be removed and reconstructed without disturbing the adjacent tracks which are to remain in operation. Because of the constraints presented, a top-down construction method is recommended to construct the abutments. For the purposes of this report, the tracks were replaced from north to south.

4.5.2. Construction Duration

The construction of the new undergrade bridge will be performed in seven phases. There will be one phase for each track since only one track can be taken out of service at a time. It is estimated that each track outage will require 150 calendar days to complete the necessary bridge reconstruction. The seven track outages and the five months needed to complete the roadway work for Elm Street add up to an estimated construction duration of 3 years, 10 months. Please refer to Appendix C for the construction schedule.

4.5.3. Estimated Construction Costs

Construction cost estimates have been developed based on the weighted unit prices listed in the Connecticut Department of Transportation's Item Master File (December 2010) and the CTDOT's Preliminary Cost Estimating Guidelines (January 2011). The cost estimates do not include costs associated with environmental studies, environmental remediation, rights-of-way acquisitions, or professional services for survey, design, or construction engineering and inspection. The construction costs for the Elm Street site are summarized as follows:

Alternative 1: Concrete-Encased Steel Beams

| | | |
|---|-----------|-------------------|
| Roadway, Drainage, Traffic and Structures | \$ | 27,877,000 |
| Utilities | \$ | 1,5643,000 |
| Railroad | \$ | 10,575,000 |
| Incidentals & Contingencies | \$ | 7,806,000 |
| Total | \$ | 47,821,000 |

Alternative 2: Multi Steel Girders

| | | |
|---|----|------------|
| Roadway, Drainage, Traffic and Structures | \$ | 26,628,000 |
| Utilities | \$ | 1,563,000 |

| | | |
|-----------------------------|-----------|-------------------|
| Railroad | \$ | 10,217,000 |
| Incidentals & Contingencies | \$ | 7,456,000 |
| Total | \$ | 45,864,000 |

5. OTHER STRUCTURES

No other structures are proposed for Elm Street.

6. TRAFFIC

6.1. Traffic Operational Requirements

Elm Street is multi-lane road that is classified as a Minor Urban Arterial. It provides three 12-foot lanes without shoulders as it passes under the MNRR bridge. Two lanes are designated for northbound traffic, and a single lane is designated for southbound traffic. A major intersection with South State Street is located immediately to the north of the bridge, between the railroad and Interstate 95 immediately east of this intersection is an eastbound entrance ramp to the Interstate. About 300 feet south of the bridge, Elm Street intersects Cherry Street and Elm Court at a slightly dog-legged intersection.

In addition, North State Street intersects Elm Street just north of Interstate 95. The effect of these closely spaced, heavily utilized, signalized intersections is a condition where traffic flows are heavily impacted by both upstream and downstream operations. Queuing between these intersections can lead to congestion at adjoining locations even though the basic intersection capacity may theoretically be sufficient. Intersection signal timings, phasing and system coordination influence the operation and level of service within the entire corridor.

Capacity analyses show that the intersections along Elm Street are currently operating very close to capacity and will continue to do so or, in some cases, slightly exceed capacity through the 2029 design year. Queuing is problematic in the corridor, with several northbound and southbound queue lengths exceeding the available distance between intersections.

Discussions with CTDOT and the City of Stamford led to the adoption of a cross section under the bridge that will provide better geometry and increased capacity for the corridor, adding a second southbound through lane and a third northbound lane for right turning traffic. In addition, shoulders will be provided in both directions. These lane arrangements are designed to match the Stamford Urban Transitway improvements that are proposed for the corridor, including the Cherry Street/Elm Court intersection, which will be widened, realigned to eliminate the dog-leg, and signalized as part of that project. These additional lanes will provide overall better levels of service, increased safety, reduced queuing, and reduce levels of congestion in the corridor.

The substantial revision to the Elm Street curb line under the MNRR bridge and the modifications to the lane arrangements will require new signal head locations at the South State Street intersection. Because of the difficulties associated with the relocation of signal heads and wiring on an existing span wire assembly, it is likely that new signal poles, signals and wiring will be necessary. The new signal poles would likely follow Stamford's preference of using mast arm installations instead of span poles and wire. In addition, new vehicle detectors will be needed to accommodate the revised alignments and lane usage. It is potentially possible that the existing traffic signal controller could be maintained. A final determination of the viability of this alternative will be made during final design.

It appears that the traffic signal installations at the intersections of the SUT, Cherry Street and North State Street can be maintained.

6.2. M&PT Requirements

Elm Street under MNRR will be widened to include three 11-foot lanes in the northbound direction with 2-foot shoulders to provide for a right-turn only lane approaching South State Street. The southbound direction will provide two 11-foot lanes. An 8-foot wide median will divide each direction of traffic, and 8-foot wide sidewalks will be provided on each side of Elm Street.

The proposed horizontal alignment for Elm Street under MNRR will follow the existing layout. The vertical alignment on Elm Street will consist of a sag curve to provide a minimum clearance of 14'-6" under the MNRR bridge. This will require Elm Street to be lowered by approximately 1 foot and will impact the underground utilities at this location. The impacted utilities identified include:

- Low Pressure Gas
- Sanitary Sewer
- Water
- Telephone with fiberoptics (2)
- Overhead Electric.

Although the exact depths of these facilities are presently not known, it is assumed that the utilities will have to be lowered to accommodate the roadway profile.

The proposed alignment will result in some roadway widening to the east and to the west. The layout, the location of the center pier, and the required utility relocations limit the space available for the maintenance of travel ways. It is anticipated that there will be two construction stages. In the first stage, the roadway will be reduced to a single 12-foot lane of traffic with 1-foot shoulders on both sides. This lane could be designated for northbound traffic or southbound traffic exclusively, or reversed to flow in the peak hour traffic direction, or flagged for alternating one-way traffic during off-peak hours. In the second stage, there will be a single southbound 10-foot lane, two 10-foot lanes in the northbound direction, and 2-foot shoulders on both sides. Please refer

to Figures 6.1a and 6.1b for the 2-stage maintenance and protection of traffic plan. These figures are located in Appendix G.

Alternate routes around Elm Street include the use of Canal Street or Myrtle Street to East Main Street to cross the railroad. It should also be noted that during the construction period, vertical clearances will be severely limited. Alternate routes for trucks and emergency vehicles will need to be established, along with detour routes for whichever directional flow is closed.

Pedestrian detours will need to be developed whenever a sidewalk under a bridge is closed. Pedestrians should be directed to cross at the nearest signalized intersection on either side of the bridge. These detours will be developed during the final design stages.

7. DRAINAGE

7.1. Existing System Conditions

The existing Elm Street profile has a low point beneath the MNRR bridge crossing. A 42-inch RCP (note that the design plans for the SUT show this as a 36-inch RCP) collects the surface runoff from points north and south along Elm Street and ties into an existing 48-inch cross culvert near station 100+65. This is part of a large culvert system running from north of East Main Street to the Harborview Avenue pump station to the south, finally discharging to the East Branch Canal. Based on City records of the SUT, the 48-inch pipe shown on the survey is a twin 48-inch culvert which connects a flow line from an existing 60-inch RCP to a 72-inch ACCMP. It proceeds to a 78-inch ACCMP running southeast down Cherry Street, then travels south down Harborview Avenue to a pump station near the intersection of Harborview and Pumping Station Road. This pump station eventually discharges to the East Branch Canal. Due to inconsistencies and inaccessible pipes, for this study the SUT plans will be used for the 48-inch pipe and Cherry Street system (it was assumed the 48-inch pipe south of the bridge as shown in the survey was not correct due to the contributing pipe upstream and the city plans showing the larger pipes downstream). For final design, pipes and inverts of the entire system should be verified. Please refer to Figure 7.1 located in Appendix G for the Drainage Plan.

7.2 System Constraints and Concepts Considered

Due to the widening and lowering of Elm Street by over 2 feet, it appears that all inlets within the work limits will have to be abandoned or relocated as shown in Figure 7.1. To replace the inlets within the section of profile lowering, a catch basin is proposed on either side of the road at the sag point (Station 103+40) with flanker basins on either side set at +0.5 feet. The two legs of the proposed drainage system will then tie together at a manhole at Station 102+69, 22' LT, and continue down station to tie into the first 48-inch RCP through another manhole at Station 100+65, 18' LT. Pipe sizes required for this proposal are 15-inch at a 0.5% slope beneath the bridge with an 18-

inch and 30-inch down the line to provide capacity and storage in the event of high tailwater.

It is recommended to preserve the existing 42-inch trunkline and associated manholes (resetting the tops) in order to maintain the existing flow line to the 48-inch cross culvert. Points northwest of the MNRR bridge appear to tie into this trunkline and connect to the existing cross culvert. The benefits here are twofold: the low point system would be independent of the adjacent system to the point of tie-in at the 48-inch culvert and the extent of the connecting systems is not known but expected to be extensive. A check of the 42-inch trunkline in relation to the proposed grading under the MNRR bridge indicates that clearance to the soffit may be as low as 1.4' (unless it can be shown that this pipe is a 36-inch as shown on the SUT design which would give 1.9' of cover). At the point of tie-in, it is expected that there would be a negligible increase in runoff to the receiving system on Cherry Street.

7.3 Design Criteria

The City of Stamford requires that the storm sewer design accommodate a 25-year event. All other requirements for storm sewer design will adhere to the Connecticut Department of Transportation Drainage Manual. Specifically:

- low points will be analyzed for a 25-year event
- on-grade gutter flow spread will be one half of the travel lane at maximum
- sag condition gutter flow spread will be all but one lane width at maximum
- storm sewer design will address full flow (non-pressure) conditions

7.4 Design Documentation

The drainage proposal for Elm Street includes providing a catch basin at the sag points with flanker basins on either side as shown on Figure 7.1. The proposed drainage system will be combined at a manhole down-station from the MNRR crossing and connected to the 48-inch cross culvert approximately 199 feet east-southeast from the crossing.

The field survey has indicated that the invert of the 48-inch cross culvert on the north-east drainage chamber is 3.0 feet. The southern chamber and invert, however, were not called out. To supplement this information, the developed profile for the SUT was used to determine a flow line of the 48-inch twin culvert.

Due to inconsistencies between the City plans for the SUT and field survey prepared for this study, a correction factor after datum and unit conversion is required. For this location, the correction was taken as the difference in elevation at the manhole invert of the 42-inch trunkline between the two maps (after unit and datum conversion) at Station 100+87, 4' LT. On the City design plans, this invert was called out as 0.82 meters (datum NGVD '29). Converted to feet, the invert is 2.69 feet and converted to NAVD '88, it is 1.59' (NGVD '29 to NAVD '88 in Stamford is -1.1 feet). The project base-mapping is an additional -0.49 feet. This correction was used when converting the SUT

profile elevation to use on this project, and resulted in a flow line of 0.65 feet (datum NAVD '88).

At the low point, the pipe invert was set to maintain 2 feet of cover over a 15-inch pipe, and the flow line slope was limited to a minimum of 0.5%.

7.4.1 Gutter flow

Gutter flow to the low points has been calculated from best available information. Drainage areas which were delineated are preliminary and subject to final grading based on the vertical profile. The area contributing to the low point at Station 103+40 LT is approximately 0.60 acres and consists largely of impervious roadway surface limited to Elm Street. Assuming a minimum time of concentration of 5 minutes based on impervious surfaces, the design rainfall event (25-yr) is 6.7 inches per hour. This, along with an assumed runoff coefficient of 0.9, yields 3.6 cfs of runoff being contributed to this point. Computed depth and spread to this point is 0.3 feet and 15 feet, respectively, using a double grate configuration. This will maintain one open travel lane for the design event.

The area contributing to the sag point at 103+40 RT is approximately 0.5 acres and consists largely of impervious roadway surface also limited to Elm Street. Assumptions for this flow determination are the same as before, resulting in 3.0 cfs of runoff contributing. Computed depth and spread to this point is 0.3 feet and 17 feet, respectively, which will maintain more than one open travel lane during the design event.

7.4.2 Pipe flow

At 3.6 cfs and 3.0 cfs entering the subsurface system for the southwest and northeast legs of this system, respectively, at the prescribed 0.5% slope, a 15-inch pipe size is required to convey this flow as based on Manning's equation for flow in storm drains. Where the northeastern leg ties to the first proposed manhole, an 18-inch pipe is required. The last pipe which ties into the existing 48-inch pipe also required an 18-inch pipe diameter to convey the total system flow; however, was upgraded as stated in the following section in order to provide additional storage within the system during the design event.

7.4.3 Hydraulic Grade Line

At this time, no backup computations on the twin 48-inch cross culverts beneath Elm Street have been located. It is known that these pipes were originally constructed to convey a brook beneath the road. Over time, the adjacent reaches of this brook have been completely buried. The assumption made for this study was that the 48-inch pipes would be running full during the design event of 25-years. This provides for a starting water surface elevation of 4.65 feet (datum NAVD '88) with which to begin the hydraulic grade line computations. The first iteration of these computations resulted in surcharging of the hydraulic grade line (HGL) at the

low point. By increasing the capacity of the last leg of the proposed system to 30-inch, the HGL was brought down to just below the top of grate elevation for the proposed inlets. The minimum provided freeboard for this configuration is at the northeastern sag catch basin and is 0.35 feet to the top of grate. Please note that the inverts as opposed to the crowns of pipes were matched. This is to provide as close to 2 feet of minimum cover as possible.

7.5 Report of Potential Permit Requirements

Based on the design and assumptions made, lowering of the roadway to provide a minimum clearance to the MNRR overpass can be accommodated. For further design of the crossing and associated lowering, additional information in the receiving system will be required to ensure that the capacity is available. As a precursor to that effort, it is assumed that since the areas contributing to the receiving system are not being increased, the drainage schematic presented in this study will accommodate the proposed bridge design. The constraint to this system will be the actual computed or documented hydraulic grade line of the twin 48-inch cross culverts.

8. UTILITIES

It is anticipated that the roadway will require approximately 2 feet of lowering. At the Elm Street bridge, the impacted utilities identified are a low pressure gas main, an underground electric duct, a water main, three telephone ducts, a sanitary sewer and four utility poles. The City of Stamford also has copper communication cable attached to the bridge for their traffic operations system. This would require relocation with the bridge work. The limits of work and utilities in the project area are shown on Figure 8.1, located in Appendix G. The depth of these utilities is not known at this time and it is assumed that the utilities will have to be lowered to accommodate the roadway lowering. Vertical depth information is required to determine the limits of the actual relocation needs.

9. GEOTECHNICAL

9.1. Summary of Subsurface Conditions

9.1.1. Regional Geology

Published geologic mapping indicates that the predominant natural surficial deposits within the project area are sands overlying fines. The sand is of variable thickness, commonly in inclined forest beds and overlies thinly bedded fines of variable thickness. The underlying bedrock within the project site is mapped as principally Pumpkin Ground Member of Harrison Gneiss, which is a gray to spotted, medium to coarse grained, foliated gneiss.

9.1.2. Pilot Borings

Three geotechnical borings were performed to preliminarily explore the subsurface conditions at the site. The approximate as-drilled pilot boring locations are shown on Figure 9.1 (located in Appendix G), Elm Street Pilot Boring Program. Each

geotechnical boring was located in the field by taping from existing site features and observed and logged during drilling. Boring logs are located in Appendix F.

The geotechnical boring depths ranged between about 11 and 27 feet below the existing ground surface at their respective locations. Representative soil samples were obtained continuously to a depth of at least 10 feet and at about 5-foot intervals thereafter. Samples were collected by split-barrel sampling procedures in general accordance with ASTM D 1586 and bedrock was cored in one location to confirm its depth, nature, and quality. An observation well was installed within one of the geotechnical borings to observe longer term groundwater levels.

9.1.3. Subsurface Conditions

The subsurface conditions as interpreted from the geotechnical borings generally consisted of asphalt over fill and concrete where present over natural sand and gravel over bedrock. A detailed description of the subsurface conditions encountered in each of the test borings is contained on the logs.

The asphalt encountered was between 12 and 18 inches thick. Where encountered, the fill was approximately 3 feet thick, which was underlain by approximately 18 inches of concrete. The fill encountered in geotechnical borings B-1 and B-3 was generally classified as very loose to very dense fine to coarse sand with varying fractions of silt and gravel and trace asphalt, roots and brick.

9.1.4. Soil

Sand and gravel immediately underlies the surficial materials described above and where it was fully penetrated was between approximately 8 and 17 feet thick. The sand and gravel was generally classified as loose to very dense, fine to coarse sand with varying fractions of silt and gravel.

Bedrock was observed below the sand and gravel at depths ranging between approximately 13 and 22 feet below the existing ground surface. The bedrock generally consisted of very poor quality, medium hard, moderately weathered, gray, medium grained gneiss.

9.1.5. Groundwater

Groundwater was observed at approximately 9 feet below the existing ground surface. Fluctuations in the observed groundwater level occur due to variation in precipitation, temperature, and other factors different from those existing at the time the measurements were made.

9.2. Geotechnical Construction Issues

Based on the above bridge rehabilitation concepts, the primary geotechnical issues that are anticipated will be the following:

- Protection of active railroad operations and of the existing tracks is required.
- Protection of existing structures during construction. These structures include railroad catenary structures, overhead and underground utilities, buildings and retaining walls.
- Management and disposal of excavated materials. Since both abutments are being removed and replaced, mini-piles will be drilled and significant excavation of the embankment soils will be required. Drill spoils will have to be disposed of in accordance with State and Local requirements. Excavated soils may be able to be reused elsewhere on the project depending on the nature and quality of the materials. If not, they will have to be disposed of in accordance with State and Local requirements.

9.3. Foundation Recommendations

Based on the information available, drilled mini-piles are recommended for the support of the proposed abutments and pier. The drilled mini-piles will have a permanent casing installed to the top of bedrock and will develop their capacity in the underlying bedrock. A continuous reinforcing bar will be installed from the bottom of the rock socket to the top of the pile. The rock socket and casing would be filled with tremie placed grout.

The mini-piles will be designed to carry the required design loads in the rock socket and will be sized and reinforced appropriately to resist any other imposed loads (e.g. uplift, lateral, etc.). Based on preliminary design loads and subsurface conditions, it is estimated that rock socket lengths will be approximately 10 to 15 feet and overall mini-pile lengths will be approximately 35 to 50 feet for the center pier and abutments respectively.

10. ENVIRONMENTAL

10.1. Required Environmental Permits

Work activities proposed for Elm Street fall outside of any FEMA regulated Floodplain and Floodway. Therefore, no Flood Management Certification is anticipated for the project. Please refer to Figure 10.1 in Appendix G for a map of the 100-year FEMA floodplain.

The project site falls on the fringe of the Coastal Boundary indicating that a DEP administered Coastal Area Management Permit (CAM) will be required.

Wetland impacts are not expected for this highly urban setting, consequently local or tidal wetland permits are not anticipated.

The total project footprint is expected to be greater than 1 acre which will trigger the requirement for a DEP administered General Permit for *Stormwater and Dewatering Wastewaters from Construction Activities*.

11. SUMMARY AND CONCLUSIONS

In order to accommodate the rising traffic demands within the City of Stamford and to open up north-south access, it is necessary to address the bottlenecks that occur at the Metro-North Railroad underpasses. Additional travel lanes will be added upon the reconstruction of the undergrade bridge. The proposed new underpass will provide two 8-foot sidewalks, two-foot shoulders, three 11-foot lanes traveling in the northbound direction and two 11-foot lanes traveling in the southbound direction.

The new structure will be comprised of two spans supported by abutments and a center pier. The depth of structure will depend upon the structure type that is selected. After careful consideration of several structure types for the study, four were eliminated as not being viable. Two structure types remain as possible options: the precast multi concrete-encased beams and the multi-steel girder ballasted steel plate deck option. The structure type selected will determine the depth of which Elm Street will be lowered to obtain the minimum vertical clearance of 14'-6". The depth of lowering will determine the extent of the impacts upon nearby intersections, roadways and properties.

Impacts to rail operations will be minimized by only taking one Metro-North railroad track out of service at a time. A top-down methodology is recommended for construction of the abutments because of the restrictions on the track outages and the limited overhead access due to the catenaries. These abutments will be short stub abutments and founded on drilled mini-piles. The proposed piers will be cast in place and will be comprised of a footing, pier cap, and circular columns also founded on drilled mini-piles.

Throughout the construction process, Elm Street will remain open to traffic. Two travel lanes will be maintained, one in each direction.

APPENDIX A – HIGHWAY DESIGN CRITERIA

Elm Street is located in built-up areas with a design speed of 30 mph. Elm Street is classified as a Minor Urban Arterial according to the Connecticut Department of Transportation’s criterion for roadway design based on roadway classification.

Key design criteria are outlined in the table below.

| Elm Street - Minor Urban Arterial | | | |
|---|-------------|---------------------------------|------------------------------|
| Design Element | | Recommended Design Value | Proposed Design Value |
| Design Speed | | 30 - 40 mph | 30 mph |
| Travel Lane Width | | 10'-12' | 11' |
| Shoulder Width | Right | 4' – 8' | 2' |
| | Left | 2' – 4' | 2' |
| Cross Slope | | 1.5 – 2.0% | 2.0% |
| Turn Lane Width | | 11' | 11' |
| Turn Lane Shoulder Width | | 2' – 4' | 2' |
| Sidewalk Width | | 5' Minimum | 8' |
| Bicycle Lane | Width | 5' | N.A. |
| | Cross Slope | 2.0% | N.A. |
| Roadside Clearzones | | 14' | 10' |
| Stopping Sight Distance | | 200' | >400' ⁽²⁾ |
| Intersection Sight Distance | | 355' | 250' |
| Minimum radius (e=4.0%) | | 230' | 600' |
| Superelevation Maximum | | 4.0% | None |
| Maximum Grade | | 9.0% | 2.60% |
| Minimum Grade | | 0.5% | 0.5% |
| Vertical Curvature (K-Value) | Crest | 19 | 20 |
| | Sag | 37 | 19 |
| Minimum Vertical Clearance Under New Bridge | | 16'-3'' ⁽¹⁾ | 14'-6'' |
| Source: Figure 5D, Connecticut Department of Transportation Highway Design Manual, 2003 Edition | | | |
| (1) 14'-6'' minimum vertical clearance used. | | | |
| (2) Stopping Sight Distance is based on illuminated highway. | | | |

APPENDIX B – BRIDGE DESIGN CRITERIA

- Structure Layout
 - Bridge will span over the proposed roadway cross section conforming to the City of Stamford requirements
 - Abutments will be located outside of proposed sidewalks
 - Pier is located between the northbound and southbound lanes
 - Substructure units will be parallel or tangent to the roadway baseline, and parallel to each other

- Bridge Type
 - Superstructure
 - Bridge will consist of two simple spans supported on abutments and a pier
 - Primary replacement bridge choice will be Metro-North's preferred ballasted deck
 - Structure types considered:
 - Half-through Plate Girders
 - Two-Girder Ballasted Concrete Deck
 - Four-Girder Ballasted Steel Plate Deck
 - Multi Concrete-Encased Beams
 - Prestressed Butted Box Beams
 - Design considerations:
 - Girders are designed for strength
 - Girders also have a service criteria
 - Maximum deflection is equal to $L/640$
 - Structure type used for the purposes of this report is the multi concrete-encased beams
 - Access walkways will be provided for the purposes of servicing the tracks.
 - Substructure
 - The abutments and pier proposed are to be constructed using cast-in-place concrete. Precast concrete modules will be considered for an accelerated construction schedule.
 - Foundation
 - The footing of the abutment will be founded on mini-piles

- The footing for the pier will be on a spread footing if the proper width can be obtained given the constraints posed by M&PT. If a spread footing is not attainable, mini piles will be used.

- Structure Depth
 - Structure depth is based on a top of rail elevation to bottom of beam depth and is based on the following assumptions:
 - Rail height – 7 5/8” (typ.)
 - Depth of Concrete Tie – 8.5” (typ.)
 - Depth of Ballast below railroad tie – 8.5” (typ.) bridge was designed for an additional 3.5” to be added in the future
 - Ballast Mat – 1” (typ.)
 - Concrete Deck with Haunch – 13” (specific to the 2-girder ballasted concrete deck structure type)
 - Steel Plate – 1.5” (specific to the 4-girder ballasted steel plate deck structure type)
 - Depth of Beam (this dimension is in addition to the previously mentioned items with the exception of the half-thru girder option. For the half-thru girder option, the structure depth is equivalent to the beam depth as the top flange is at the top of rail elevation.)

- Construction
 - Stage construction is based on single track outages
 - For the purposes of this report, tracks are taken out of service from north to south
 - Construction of the abutments will use a top-down methodology
 - Catenary wires will remain in place during construction and will be maintained and protected

- Rail Geometry
 - Existing horizontal and vertical alignment will be maintained

APPENDIX C – CONSTRUCTION SCHEDULE

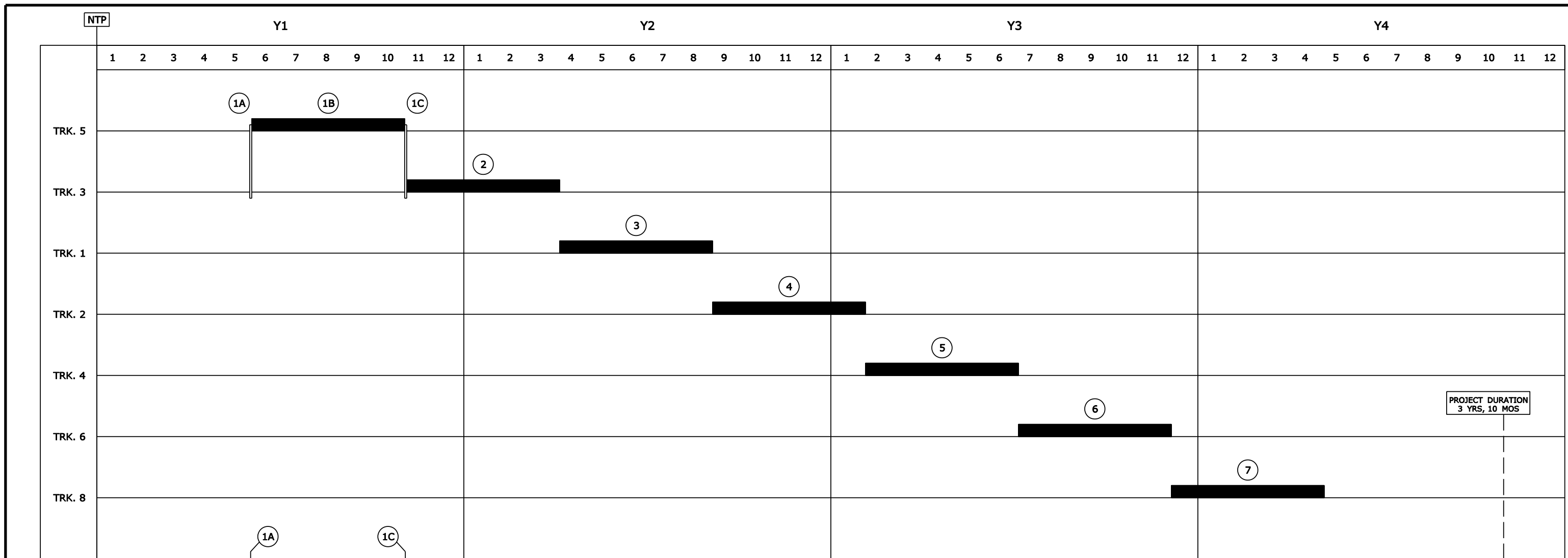

| | | | | | | | | | | | |
|---------------|--------------------|-----|-----|-----|-----|-----|-----|-----|-----|-----|--|
| STAGE NO. | MOBILIZATION STAGE | 1A | 1B | 1C | 2 | 3 | 4 | 5 | 6 | 7 | |
| CALENDAR DAYS | | 150 | 150 | 150 | 150 | 150 | 150 | 150 | 150 | 150 | |

| | | | | | | | | | | | | | |
|---------------------------|--|--|--|--|--|--|--|--|--|--|--|----------------------|-----------------|
| ELM STREET (ROAD WORK) | | | | | | | | | | | | REMOVE EX. ABUTMENTS | INSTALL ROADWAY |
|---------------------------|--|--|--|--|--|--|--|--|--|--|--|----------------------|-----------------|

LEGEND:

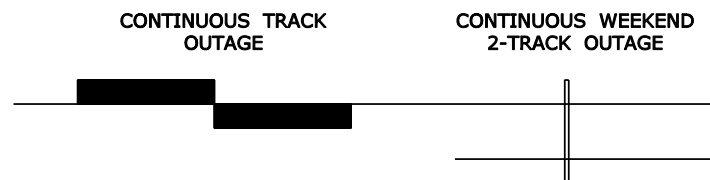

**SOUTH STAMFORD ACCESSIBILITY
& MNRR BRIDGE REPLACEMENT
FEASIBILITY STUDY**

**ELM STREET
TRACK OUTAGE SCHEDULE**

URS

SCALE: N.T.S.

APPENDIX D – CONSTRUCTION COST ESTIMATES



South Stamford Accessibility and MNRR Bridge Replacement Feasibility Study

Stamford, Connecticut
State Project No. 135-301

**PRELIMINARY ENGINEERING CONSTRUCTION COST ESTIMATE
ELM STREET**

| Item No. | Description | Unit | Unit Price | Alternative 1 | | Alternative 2 | |
|---|---|------|--------------|---|-----------------|--|-----------------|
| | | | | Quantity | Price | Quantity | Price |
| | | | | Two Span Top Down Concrete-Encased Steel Beams | | Two Span Top Down Multi Steel Girders | |
| Highway & Traffic Items | | | | | | | |
| 1. | Earth Excavation | CY | \$26.00 | 3,154 | \$82,012.67 | 3,154 | \$82,012.67 |
| 2. | Rock Excavation | CY | \$50.00 | 350 | \$17,524.07 | 350 | \$17,524.07 |
| 3. | Drainage; Pipe (15") | LF | \$60.00 | 208 | \$12,480.00 | 208 | \$12,480.00 |
| 4. | Drainage; Pipe (18") | LF | \$67.00 | 64 | \$4,288.00 | 64 | \$4,288.00 |
| 5. | Drainage; Pipe (30") | LF | \$90.00 | 200 | \$18,000.00 | 200 | \$18,000.00 |
| 6. | Drainage; Catch Basins | EA | \$2,800.00 | 6 | \$16,800.00 | 6 | \$16,800.00 |
| 7. | Drainage; Double Catch Basins | EA | \$4,500.00 | 1 | \$4,500.00 | 1 | \$4,500.00 |
| 8. | Manhole | EA | \$3,500.00 | 2 | \$7,000.00 | 2 | \$7,000.00 |
| 9. | Milling of Bituminous Concrete 0" - 4" | SY | \$8.00 | 453 | \$3,622.22 | 453 | \$3,622.22 |
| 10. | HMA - Superpave | T | \$105.00 | 1,028 | \$107,962.68 | 1,028 | \$107,962.68 |
| 11. | Processed Aggregate Base | T | \$45.00 | 1,028 | \$46,269.72 | 1,028 | \$46,269.72 |
| 12. | Subbase | T | \$35.00 | 1,171 | \$40,969.44 | 1,171 | \$40,969.44 |
| 13. | Temporary PCBC | LF | \$42.00 | 430 | \$18,060.00 | 430 | \$18,060.00 |
| 14. | Relocate TPCBC | LF | \$17.00 | 430 | \$7,310.00 | 430 | \$7,310.00 |
| 15. | PCBC (Vertical and "F" Shape) | LF | \$100.00 | 240 | \$24,000.00 | 240 | \$24,000.00 |
| 16. | Impact Attenuators | EA | \$25,000.00 | 2 | \$50,000.00 | 2 | \$50,000.00 |
| 17. | Curbing; Concrete | LF | \$30.00 | 1,490 | \$44,700.00 | 1,490 | \$44,700.00 |
| 18. | Concrete Sidewalk | SF | \$15.00 | 9,920 | \$148,800.00 | 9,920 | \$148,800.00 |
| 19. | Trafficperson (City/State Police Officer) | HR | \$75.00 | 1,300 | \$97,500.00 | 1,300 | \$97,500.00 |
| 20. | Roadway Lighting | LF | \$40.00 | 745 | \$29,800.00 | 745 | \$29,800.00 |
| 21. | Traffic Signals; New | EA | \$200,000.00 | 1 | \$200,000.00 | 1 | \$200,000.00 |
| 22. | Retaining Walls | SF | \$70.00 | 923 | \$64,575.00 | 923 | \$64,575.00 |
| Section Sub-Total | | | | | \$1,046,173.81 | | \$1,046,173.81 |
| Structures Items - Undergrade Bridge | | | | | | | |
| 23. | Structure Excavation - Earth (Complete) | CY | \$90.00 | 7,800 | \$702,000.00 | 7,800 | \$702,000.00 |
| 24. | Ballast | CY | \$175.00 | 550 | \$96,250.00 | 550 | \$96,250.00 |
| 25. | Ballast Mat | SF | \$15.00 | 11,100 | \$166,500.00 | 11,100 | \$166,500.00 |
| 26. | Pervious Structure Backfill | CY | \$105.00 | 1,300 | \$136,500.00 | 1,300 | \$136,500.00 |
| 27. | Removal of Superstructure | LS | \$350,000.00 | 1 | \$350,000.00 | 1 | \$350,000.00 |
| 28. | Removal of Substructure | LS | \$730,000.00 | 1 | \$730,000.00 | 1 | \$730,000.00 |
| 29. | Tie-Back Wall | SF | \$400.00 | 7,470 | \$2,988,000.00 | 7,470 | \$2,988,000.00 |
| 30. | Steel-Laminated Elastomeric Bearings | CI | \$3.00 | 51,100 | \$153,300.00 | 21,100 | \$63,300.00 |
| 31. | Class "A" Concrete | CY | \$850.00 | 1,200 | \$1,020,000.00 | 1,200 | \$1,020,000.00 |
| 32. | Class "F" Concrete | CY | \$1,250.00 | 200 | \$250,000.00 | 200 | \$250,000.00 |
| 33. | Architectural Formliner | SY | \$400.00 | 300 | \$120,000.00 | 300 | \$120,000.00 |
| 34. | Deformed Steel Bars | LBS | \$1.60 | 140,000 | \$224,000.00 | 140,000 | \$224,000.00 |
| 35. | Structural Steel (Site No. 1) | LBS | \$3.25 | 0 | \$0.00 | 1,966,900 | \$6,392,425.00 |
| 36. | P/C Conc. Encased Steel Girders (32"D) | LF | \$1,180.00 | 6,100 | \$7,198,000.00 | 0 | \$0.00 |
| 37. | Drilled Mini-Piles | EA | \$10,000.00 | 330 | \$3,300,000.00 | 330 | \$3,300,000.00 |
| 38. | Temporary Earth Retaining System | SF | \$50.00 | 2,030 | \$101,500.00 | 2,030 | \$101,500.00 |
| 39. | Temporary Earth Retaining System (RR) | SF | \$160.00 | 6,540 | \$1,046,400.00 | 6,540 | \$1,046,400.00 |
| 40. | Lead Health Protection Program | LS | \$100,000.00 | 1 | \$100,000.00 | 1 | \$100,000.00 |
| Section Sub-Total | | | | | \$18,682,450.00 | | \$17,786,875.00 |
| Rail Operations | | | | | | | |
| 41. | Bridge Plates | EA | \$9,000.00 | 25 | \$225,000.00 | 25 | \$225,000.00 |
| 42. | Removal & Erection Cycle - Bridge Plates | EA | \$1,200.00 | 25 | \$30,000.00 | 25 | \$30,000.00 |
| Section Sub-Total | | | | | \$255,000.00 | | \$255,000.00 |
| Project Sub-Total | | | | | | | |
| Highway & Traffic + Structure + Rail Operations | | | | | \$19,983,623.81 | | \$19,088,048.81 |



South Stamford Accessibility and MNRR Bridge Replacement Feasibility Study

Stamford, Connecticut
State Project No. 135-301

**PRELIMINARY ENGINEERING CONSTRUCTION COST ESTIMATE
ELM STREET**

| Item No. | Description | Unit | Unit Price | Alternative 1 | | Alternative 2 | |
|--|-------------------------------|------|------------|---------------|----------------|---------------|----------------|
| | | | | Quantity | Price | Quantity | Price |
| Percentage Based Items (applied to Project Sub-Total) | | | | | | | |
| 1. | Clearing and Grubbing Roadway | @ | | 2% | \$399,672.48 | 2% | \$381,760.98 |
| 2. | M & P of Traffic | @ | | 4% | \$799,344.95 | 4% | \$763,521.95 |
| 3. | Mobilization | @ | | 7.5% | \$1,498,771.79 | 7.5% | \$1,431,603.66 |
| 4. | Construction Staking | @ | | 1% | \$199,836.24 | 1% | \$190,880.49 |
| 5. | Minor Items | @ | | 25% | \$4,995,905.95 | 25% | \$4,772,012.20 |
| Section Sub-Total | | | | | \$7,893,531.40 | | \$7,539,779.28 |

| Project Total | | | | |
|--|--|--|-----------------|-----------------|
| Project Sub-Total + Percentage Based Items | | | \$27,877,155.21 | \$26,627,828.09 |

| Utility Relocation Costs | | | | | | | |
|---------------------------------|--------------------|------|----------------|---|----------------|---|----------------|
| 1. | Utility Relocation | Est. | \$1,563,500.00 | 1 | \$1,563,500.00 | 1 | \$1,563,500.00 |
| Section Sub-Total | | | | | \$1,563,500.00 | | \$1,563,500.00 |

| Railroad Costs | | | | | | | |
|-----------------------|--|------|----------------|-----|-----------------|-----|-----------------|
| 1. | RR Force Account Work ^{1&2} | @ | | 40% | \$7,574,980.00 | 40% | \$7,216,750.00 |
| 2. | Temporary Cut and Throw | Est. | \$3,000,000.00 | 1 | \$3,000,000.00 | 1 | \$3,000,000.00 |
| Section Sub-Total | | | | | \$10,574,980.00 | | \$10,216,750.00 |

| Incidentals and Contingencies (applied to Project Total) | | | | | | | |
|---|---------------|---|--|-----|----------------|-----|----------------|
| 1. | Incidentals | @ | | 18% | \$5,017,887.94 | 18% | \$4,793,009.06 |
| 2. | Contingencies | @ | | 10% | \$2,787,715.52 | 10% | \$2,662,782.81 |
| Section Sub-Total | | | | | \$7,805,603.46 | | \$7,455,791.86 |

| | | | |
|--|------------|------------------------|------------------------|
| Cost of Bridge Replacement (2011) | | \$47,821,238.67 | \$45,863,869.95 |
| | SAY | \$47,800,000.00 | \$45,900,000.00 |

| Inflation to Mid-Point of Construction | | | | | |
|---|-----------|----|-----------------|----|-----------------|
| Price Adjustment (adjust to 2016) | 5 years @ | 5% | \$13,212,126.54 | 5% | \$12,671,341.65 |

| | | | |
|--|------------|------------------------|------------------------|
| Cost of Bridge Replacement (2016) | | \$61,033,365.21 | \$58,535,211.60 |
| | SAY | \$61,000,000.00 | \$58,500,000.00 |

Project Cost Escalation Footnotes:

- Estimated construction cost shown above is based on 2011 prices.
- Rate of construction cost escalation is estimated at 5% per year, per CTDOT Estimating Guidelines, calculated to the mid-point of construction, which is anticipated to be 2016 based on an anticipated 2014 start of construction. Accordingly, the cost escalation factor is 1.28.

NOTES:

- MNRR Force Account value is based on 40% of the sum of the total structure and rail operations work for the Undergrade Bridge + 25% minor items applied to that total.
- MNRR Force Account includes the cost of Metro North personnel and railroad work associated with the removal of the existing bridge and construction of the proposed bridge, including removal & replacement of railroad tracks, communications & signals, and catenary pole relocation where applicable.
- Items NOT included in this estimate:
 - Building Demolition / ROW acquisitions
 - Environmental Remediation
 - Environmental Studies (20% of Environmental Remediation Costs)

APPENDIX E – DRAINAGE COMPUTATIONS

Hydraflow Storm Sewers Plan

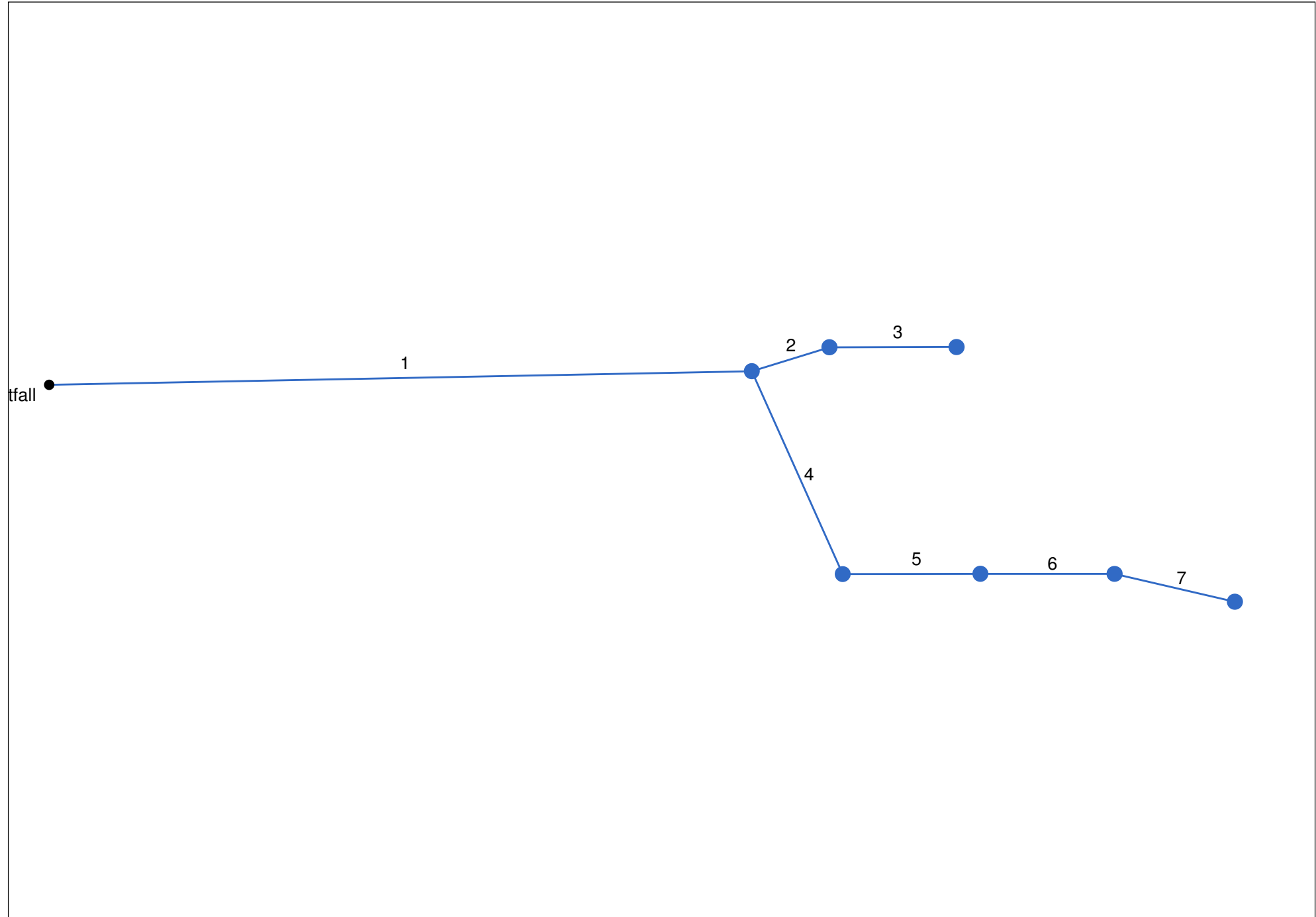

Inlet Report

| Line No | Inlet ID | Q = CIA (cfs) | Q carry (cfs) | Q capt (cfs) | Q byp (cfs) | Junc type | Curb Inlet | | Grate Inlet | | | Gutter | | | | | | Inlet | | | Byp line No | |
|---------|----------|------------------|------------------|-----------------|----------------|-----------|------------|--------|-------------|--------|--------|------------|--------|------------|------------|-------|------------|-------------|------------|-------------|-------------|-----------|
| | | | | | | | Ht (in) | L (ft) | area (sqft) | L (ft) | W (ft) | So (ft/ft) | W (ft) | Sw (ft/ft) | Sx (ft/ft) | n | Depth (ft) | Spread (ft) | Depth (ft) | Spread (ft) | | Depr (in) |
| 1 | | 0.00 | 0.00 | 0.00 | 0.00 | MH | 0.0 | 0.00 | 0.00 | 0.00 | 0.00 | Sag | 0.00 | 0.000 | 0.000 | 0.013 | 0.00 | 0.00 | 0.00 | 0.00 | 0.0 | Off |
| 2 | | 0.00 | 0.00 | 0.00 | 0.00 | MH | 0.0 | 0.00 | 0.00 | 0.00 | 0.00 | Sag | 0.00 | 0.000 | 0.000 | 0.000 | 0.00 | 0.00 | 0.00 | 0.00 | 0.0 | Off |
| 3 | | 3.62 | 0.00 | 3.62 | 0.00 | Grate | 0.0 | 0.00 | 6.26 | 4.62 | 1.35 | Sag | 2.00 | 0.020 | 0.020 | 0.015 | 0.30 | 15.02 | 0.30 | 15.02 | 0.0 | Off |
| 4 | | 0.00 | 0.00 | 0.00 | 0.00 | MH | 0.0 | 0.00 | 0.00 | 0.00 | 0.00 | Sag | 0.00 | 0.000 | 0.000 | 0.000 | 0.00 | 0.00 | 0.00 | 0.00 | 0.0 | Off |
| 5 | | 3.01 | 0.00 | 3.01 | 0.00 | Grate | 0.0 | 0.00 | 3.13 | 2.31 | 1.35 | Sag | 2.00 | 0.020 | 0.020 | 0.015 | 0.34 | 17.12 | 0.34 | 17.12 | 0.0 | Off |
| 6 | | 0.00 | 0.00 | 0.00 | 0.00 | MH | 0.0 | 0.00 | 0.00 | 0.00 | 0.00 | Sag | 0.00 | 0.000 | 0.000 | 0.000 | 0.00 | 0.00 | 0.00 | 0.00 | 0.0 | Off |
| 7 | | 1.66 | 0.00 | 1.66 | 0.00 | Grate | 0.0 | 0.00 | 3.13 | 2.31 | 1.35 | Sag | 2.00 | 0.020 | 0.020 | 0.015 | 0.23 | 11.49 | 0.23 | 11.49 | 0.0 | Off |

Project File: elm street drainage.stm

Number of lines: 7

Run Date: 09-16-2010

NOTES: Inlet N-Values = 0.016 ; Intensity = 101.98 / (Inlet time + 15.80) ^ 0.90; Return period = 25 Yrs. ; * Indicates Known Q added. All curb inlets are Horiz throat.

Storm Sewer Tabulation

| Station | | Len (ft) | Drng Area | | Rnoff coeff (C) | Area x C | | Tc | | Rain (l) (in/hr) | Total flow (cfs) | Cap full (cfs) | Vel (ft/s) | Pipe | | Invert Elev | | HGL Elev | | Grnd / Rim Elev | | Line ID |
|---------|------------|-------------|--------------|---------------|-----------------------|----------|-------|----------------|---------------|------------------------|------------------------|----------------------|---------------|--------------|--------------|-------------|------------|------------|------------|-----------------|------------|---------|
| Line | To Line | | Incr (ac) | Total (ac) | | Incr | Total | Inlet (min) | Syst (min) | | | | | Size (in) | Slope (%) | Dn (ft) | Up (ft) | Dn (ft) | Up (ft) | Dn (ft) | Up (ft) | |
| 1 | End | 199 | 0.00 | 1.70 | 0.00 | 0.00 | 1.29 | 0.0 | 11.6 | 5.2 | 6.76 | 31.50 | 1.38 | 30 | 0.50 | 0.65 | 1.65 | 4.65 | 4.70 | 10.14 | 7.26 | |
| 2 | 1 | 23 | 0.00 | 0.60 | 0.00 | 0.00 | 0.54 | 0.0 | 5.2 | 6.6 | 3.59 | 10.42 | 2.92 | 15 | 2.22 | 1.65 | 2.16 | 4.72 | 4.78 | 7.26 | 6.30 | |
| 3 | 2 | 36 | 0.60 | 0.60 | 0.90 | 0.54 | 0.54 | 5.0 | 5.0 | 6.7 | 3.62 | 5.08 | 2.95 | 15 | 0.53 | 2.16 | 2.35 | 4.83 | 4.93 | 6.30 | 5.80 | |
| 4 | 1 | 63 | 0.00 | 1.10 | 0.00 | 0.00 | 0.75 | 0.0 | 11.1 | 5.3 | 3.99 | 7.98 | 2.26 | 18 | 0.49 | 1.65 | 1.96 | 4.72 | 4.80 | 7.26 | 6.10 | |
| 5 | 4 | 39 | 0.50 | 1.10 | 0.90 | 0.45 | 0.75 | 5.0 | 10.9 | 5.4 | 4.02 | 4.88 | 3.27 | 15 | 0.49 | 1.96 | 2.15 | 4.87 | 5.00 | 6.10 | 5.60 | |
| 6 | 5 | 38 | 0.00 | 0.60 | 0.00 | 0.00 | 0.30 | 0.0 | 10.4 | 5.4 | 1.63 | 4.95 | 1.33 | 15 | 0.50 | 2.15 | 2.34 | 5.23 | 5.25 | 5.60 | 6.10 | |
| 7 | 6 | 35 | 0.60 | 0.60 | 0.50 | 0.30 | 0.30 | 10.0 | 10.0 | 5.5 | 1.66 | 4.88 | 1.35 | 15 | 0.49 | 2.34 | 2.51 | 5.25 | 5.27 | 6.10 | 6.39 | |

Project File: elm street drainage.stm

Number of lines: 7

Run Date: 09-16-2010

NOTES: Intensity = 101.98 / (Inlet time + 15.80) ^ 0.90; Return period = 25 Yrs. ; c = cir e = ellip b = box

Hydraulic Grade Line Computations

| Line | Size (in) | Q (cfs) | Downstream | | | | | | | | Len (ft) | Upstream | | | | | | | | Check | | JL coeff (K) | Minor loss (ft) |
|------|--------------|------------|------------------------|---------------------|---------------|----------------|---------------|---------------------|---------------------|-----------|-------------|------------------------|---------------------|---------------|----------------|---------------|---------------------|---------------------|-----------|------------------|-----------------------|--------------------|-----------------------|
| | | | Invert elev (ft) | HGL elev (ft) | Depth (ft) | Area (sqft) | Vel (ft/s) | Vel head (ft) | EGL elev (ft) | Sf (%) | | Invert elev (ft) | HGL elev (ft) | Depth (ft) | Area (sqft) | Vel (ft/s) | Vel head (ft) | EGL elev (ft) | Sf (%) | Ave Sf (%) | Enrgy loss (ft) | | |
| 1 | 30 | 6.76 | 0.65 | 4.65 | 2.50 | 4.91 | 1.38 | 0.03 | 4.68 | 0.023 | 199 | 1.65 | 4.70 | 2.50 | 4.91 | 1.38 | 0.03 | 4.73 | 0.023 | 0.023 | 0.046 | 0.93 | 0.03 |
| 2 | 15 | 3.59 | 1.65 | 4.72 | 1.25 | 1.23 | 2.92 | 0.13 | 4.86 | 0.263 | 23 | 2.16 | 4.78 | 1.25 | 1.23 | 2.92 | 0.13 | 4.92 | 0.263 | 0.263 | 0.060 | 0.34 | 0.05 |
| 3 | 15 | 3.62 | 2.16 | 4.83 | 1.25 | 1.23 | 2.95 | 0.14 | 4.96 | 0.268 | 36 | 2.35 | 4.93 | 1.25 | 1.23 | 2.95 | 0.14 | 5.06 | 0.267 | 0.268 | 0.096 | 1.00 | 0.14 |
| 4 | 18 | 3.99 | 1.65 | 4.72 | 1.50 | 1.77 | 2.26 | 0.08 | 4.80 | 0.123 | 63 | 1.96 | 4.80 | 1.50 | 1.77 | 2.26 | 0.08 | 4.88 | 0.123 | 0.123 | 0.077 | 0.93 | 0.07 |
| 5 | 15 | 4.02 | 1.96 | 4.87 | 1.25 | 1.23 | 3.27 | 0.17 | 5.04 | 0.330 | 39 | 2.15 | 5.00 | 1.25 | 1.23 | 3.27 | 0.17 | 5.17 | 0.330 | 0.330 | 0.129 | 0.50 | 0.08 |
| 6 | 15 | 1.63 | 2.15 | 5.23 | 1.25 | 1.23 | 1.33 | 0.03 | 5.25 | 0.054 | 38 | 2.34 | 5.25 | 1.25 | 1.23 | 1.33 | 0.03 | 5.27 | 0.054 | 0.054 | 0.021 | 0.27 | 0.01 |
| 7 | 15 | 1.66 | 2.34 | 5.25 | 1.25 | 1.23 | 1.35 | 0.03 | 5.28 | 0.056 | 35 | 2.51 | 5.27 | 1.25 | 1.23 | 1.35 | 0.03 | 5.30 | 0.056 | 0.056 | 0.020 | 1.00 | 0.03 |

Project File: elm street drainage.stm

Number of lines: 7

Run Date: 09-16-2010

; c = cir e = ellip b = box

APPENDIX F – BORING LOGS

| | | | | |
|-----------------------|---|--------------------------------------|--|---------------|
| | | Connecticut DOT Boring Report | | Hole No.: B-1 |
| Inspector: R. Janeiro | Town: Stamford | Project No.: 0101-025.00 | | Stat./Offset: |
| Engineer: J. Kidd | Route No.: | Easting: | | Northing: |
| Start Date: 9-2-10 | Bridge No.: | Surface Elevation: | | |
| Finish Date: 9-2-10 | Project Description: Elm Street, Pilot Boring Program | | | |

| | | |
|---------------------------------|----------------------------------|----------------------|
| Casing Size/Type: 3"/NW | Sampler Type/Size: SS/1-3/8" | Core Barrel Type: NX |
| Hammer Wt.: 300 lb. Fall: 24in. | Hammer Wt.: 140 lb. Fall: 30 in. | |

Groundwater Observations: @9 ft. after 0 hours

| Depth (ft) | SAMPLES | | | | | Generalized Strata Description | Material Description and Notes | Elevation (ft) | | |
|------------|-----------------|-------------------------------|----|----|----|--------------------------------|--------------------------------|---|------------|---|
| | Sample Type/No. | Blows on Sampler per 6 inches | | | | | | | Pen. (in.) | Rec. (in.) |
| 0 | | | | | | | Asphalt | | | |
| | S-1 | 8 | 28 | 47 | 45 | 24 | 9 | S-1: Very dense, brown fine to coarse SAND, some fine to coarse Gravel, little Silt, trace Brick and Asphalt fragments S-2: Asphalt and Brick fragments jammed at tip of spoon S-3: Loose, olive fine to coarse SAND, little Silt, trace fine Gravel S-4, Medium dense, brown fine to coarse SAND, little Silt, trace fine Gravel S-5: Very dense, brown fine to coarse SAND and fine to coarse GRAVEL, little Silt | | |
| | S-2 | 106/5" | | | | 5 | 2 | | | |
| | | | | | | | Concrete | | | |
| 5 | S-3 | 5 | 3 | 4 | 10 | 24 | 14 | | | |
| | S-4 | 9 | 7 | 11 | 5 | 24 | 4 | | | |
| 10 | S-5 | 34 | 76 | 80 | 53 | 24 | 10 | | | |
| | | | | | | | | | | |
| | | | | | | | | | | |
| 15 | C-1 | | | | | 47 | 34 | 20 | Bedrock | C-1: Poor Quality, Moderately Hard to Hard, Moderately Weathered, gray, GNEISS, with Granofes up to 1/2" wide |
| | | | | | | | | | | END OF BORING 16.9ft |
| 20 | | | | | | | | | | |

Sample Type: S = Split Spoon C = Core UP = Undisturbed Piston V = Vane Shear Test
Proportions Used: Trace = 1 - 10%, Little = 10 - 20%, Some = 20 - 35%, And = 35 - 50%

| | | |
|--|--------|--------------------|
| Total Penetration in Earth: 13ft Rock: 3.75ft | NOTES: | Sheet 1 of 1 |
| No. of Soil Samples: 5 No. of Core Runs: 1 | | SM-001-M REV. 1/02 |

| Inspector: R. Janeiro Engineer: J. Kidd | | Connecticut DOT Boring Report | | | | Hole No.: B-2 (OW) | | | |
|---|-----------------|--------------------------------------|--------------------------|-----------|----------------------|--------------------------------|--------------------------------|-------------------|----------------|
| | | Town: Stamford | Project No.: 0101-025.00 | | Stat./Offset: | | | | |
| Start Date: 9-8-10 | | Route No.: | | Northing: | | | | | |
| Finish Date: 9-8-10 | | Bridge No.: | | Easting: | | | | | |
| Surface Elevation: | | | | | | | | | |
| Project Description: Elm Street, Pilot Boring Program | | | | | | | | | |
| Casing Size/Type: 3"/NW | | Sampler Type/Size: SS/1-3/8" | | | Core Barrel Type: NX | | | | |
| Hammer Wt.: 300 lb. Fall: 24in. | | Hammer Wt.: 140 lb. Fall: 30 in. | | | | | | | |
| Groundwater Observations: @9 ft. after 0 hours | | | | | | | | | |
| Depth (ft) | SAMPLES | | | | | Generalized Strata Description | Material Description and Notes | Well Construction | Elevation (ft) |
| | Sample Type/No. | Blows on Sampler per 6 inches | | | | | | | |
| 0 | | | | | | | Asphalt | | |
| | S-1 | 13 | 19 | 23 | 21 | 24 | 14 | | |
| | S-2 | 36 | 28 | 28 | 26 | 24 | 11 | | |
| 5 | S-3 | 20 | 32 | 37 | 34 | 24 | 15 | | |
| | S-4 | 39 | 26 | 22 | 18 | 24 | 14 | | |
| 10 | S-5 | 16 | 18 | 16 | 18 | 24 | 15 | | |
| | | | | | | | | | |
| | | | | | | | | | |
| | | | | | | | | | |
| 15 | | | | | | | | | |
| | | | | | | | | | |
| | | | | | | | | | |
| | | | | | | | | | |
| 20 | | | | | | | | | |
| END OF BORING 11ft | | | | | | | | | |

Sample Type: S = Split Spoon C = Core UP = Undisturbed Piston V = Vane Shear Test
Proportions Used: Trace = 1 - 10%, Little = 10 - 20%, Some = 20 - 35%, And = 35 - 50%

| | | |
|------------------------|---------------------|--------|
| Total Penetration in | | NOTES: |
| Earth: 11ft | Rock: 0ft | |
| No. of Soil Samples: 5 | No. of Core Runs: 0 | |

| | | | | |
|-----------------------|----------------|--------------------------------------|--------------------|---------------|
| | | Connecticut DOT Boring Report | | Hole No.: B-3 |
| Inspector: R. Janeiro | Town: Stamford | Project No.: 0101-025.00 | | Stat./Offset: |
| Engineer: J. Kidd | Route No.: | Bridge No.: | | Northing: |
| Start Date: 9-1-10 | | | Easting: | |
| Finish Date: 9-1-10 | | | Surface Elevation: | |

Project Description: Elm Street, Pilot Boring Program

| | | |
|---------------------------------|----------------------------------|----------------------|
| Casing Size/Type: 3"/NW | Sampler Type/Size: SS/1-3/8" | Core Barrel Type: NX |
| Hammer Wt.: 300 lb. Fall: 24in. | Hammer Wt.: 140 lb. Fall: 30 in. | |

Groundwater Observations: @None observed

| Depth (ft) | SAMPLES | | | | | Generalized Strata Description | Material Description and Notes | Elevation (ft) |
|------------|-----------------|-------------------------------|----|----|----|--------------------------------|--------------------------------|---|
| | Sample Type/No. | Blows on Sampler per 6 inches | | | | | | |
| 0 | | | | | | | Asphalt | |
| | S-1 | 14 | 2 | 1 | 4 | 24 | 12 | S-1: Very loose, Top 3": BRICK fragments Bottom 9": brown fine to coarse SAND, some Silt, trace fine Gravel, trace Roots S-2: Very dense, brown fine to coarse SAND, little Silt, little fine Gravel S-3: Very dense, brown fine to coarse SAND and fine to coarse GRAVEL, trace Silt S-4: Very dense, brown fine to coarse SAND, some fine to coarse Gravel, little Silt S-5: Medium dense, brown fine to coarse SAND, little Silt, trace fine Gravel S-6: Medium dense, brown fine to coarse SAND, trace Silt |
| | S-2 | 32 100/5" | | | | 11 | 11 | |
| | | | | | | | Concrete | |
| 5 | | | | | | | Sand & Gravel | |
| | S-3 | 22 | 28 | 31 | 37 | 24 | 14 | |
| | S-4 | 40 | 35 | 23 | 21 | 24 | 9 | |
| 10 | | | | | | | | |
| | S-5 | 9 | 9 | 10 | 11 | 24 | 10 | |
| | | | | | | | Sand | |
| 15 | | | | | | | | |
| | S-6 | 4 | 7 | 7 | 9 | 24 | 12 | |
| 20 | | | | | | | | |

Sample Type: S = Split Spoon C = Core UP = Undisturbed Piston V = Vane Shear Test
 Proportions Used: Trace = 1 - 10%, Little = 10 - 20%, Some = 20 - 35%, And = 35 - 50%

| | | |
|--|--------|--------------------|
| Total Penetration in Earth: 26.7ft Rock: 0ft | NOTES: | Sheet 1 of 2 |
| No. of Soil Samples: 8 No. of Core Runs: 0 | | SM-001-M REV. 1/02 |

| | | |
|--------------------------------------|--------------------------|--------------------|
| Connecticut DOT Boring Report | | Hole No.: B-3 |
| Inspector: R. Janeiro | Town: Stamford | Stat./Offset: |
| Engineer: J. Kidd | Project No.: 0101-025.00 | Northing: |
| Start Date: 9-1-10 | Route No.: | Easting: |
| Finish Date: 9-1-10 | Bridge No.: | Surface Elevation: |

Project Description: Elm Street, Pilot Boring Program

| | | |
|---------------------------------|----------------------------------|----------------------|
| Casing Size/Type: 3"/NW | Sampler Type/Size: SS/1-3/8" | Core Barrel Type: NX |
| Hammer Wt.: 300 lb. Fall: 24in. | Hammer Wt.: 140 lb. Fall: 30 in. | |

Groundwater Observations: @None observed

| Depth (ft) | SAMPLES | | | | | Generalized Strata Description | Material Description and Notes | Elevation (ft) | |
|------------|-----------------|-------------------------------|----|----|--------|--------------------------------|--------------------------------|----------------|---|
| | Sample Type/No. | Blows on Sampler per 6 inches | | | | | | | Pen. (in.) |
| 20 | S-7 | 6 | 4 | 4 | 6 | 24 | 12 | | S-7: Loose, brown fine to medium SAND, trace Silt |
| | | | | | | | | | |
| 25 | S-8 | 24 | 20 | 33 | 100/4" | 22 | 10 | | S-8: Very dense, brown fine to coarse GRAVEL and fine to coarse SAND, trace Silt, with Rock fragments |
| | | | | | | | | | END OF BORING 26.7ft |
| 30 | | | | | | | | | |
| 35 | | | | | | | | | |
| 40 | | | | | | | | | |

Sample Type: S = Split Spoon C = Core UP = Undisturbed Piston V = Vane Shear Test
Proportions Used: Trace = 1 - 10%, Little = 10 - 20%, Some = 20 - 35%, And = 35 - 50%

| | | |
|---|--------|--------------------|
| Total Penetration in Earth: 26.7ft Rock: 0ft | NOTES: | Sheet 2 of 2 |
| No. of Soil Samples: 8 No. of Core Runs: 0 | | SM-001-M REV. 1/02 |

APPENDIX G – FIGURES

LIST OF FIGURES

Highway

- Figure 2.1 – Project Area
- Figure 2.2 – Roadway Plan
- Figure 2.3a-b – Roadway Profiles
- Figure 2.4 – Roadway Cross Section

Rail Operations

- Figure 3.1a-3.1i – Rail Staging and Sequencing Plans for Bridge 03686R

Bridge 03686R

- Figure 4.1 – General Plan & Elevation
Bridge 03686R (continued)
- Figure 4.2 – Typical Sections
- Figure 4.3a-d – Construction Staging Sections
- Figure 4.4 – Abutment
- Figure 4.5 – Pier

Traffic

- Figure 6.1a-b – Maintenance and Protection of Traffic

Drainage

- Figure 7.1 – Drainage Plan

Utilities

- Figure 8.1 – Utility Plan

Geotechnical

- Figure 9.1 – Boring Plan

Environmental

- Figure 10.1 – 100 Year FEMA Floodplain

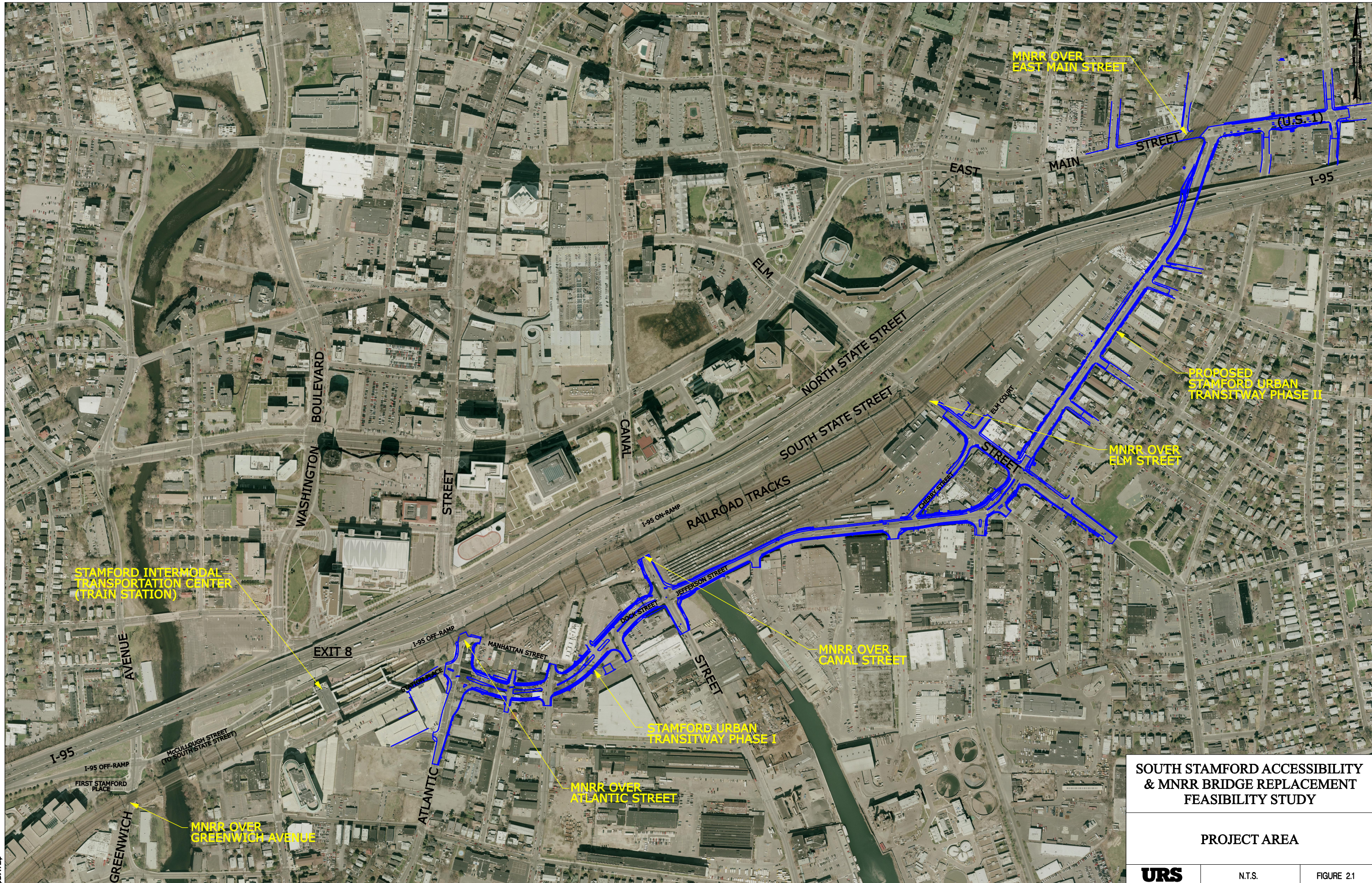

SOUTH STAMFORD ACCESSIBILITY & MNRR BRIDGE REPLACEMENT FEASIBILITY STUDY

PROJECT AREA

URS

N.T.S.

FIGURE 2.1

FILES
DATES

P:\CTDOT_projects\135-301\Highways\Phase-2\Elm\MSa_Contract_Sheet_Files\HW_MSH_135-301_PLAN_Elm-2Span.dgn
10/19/2010

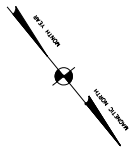
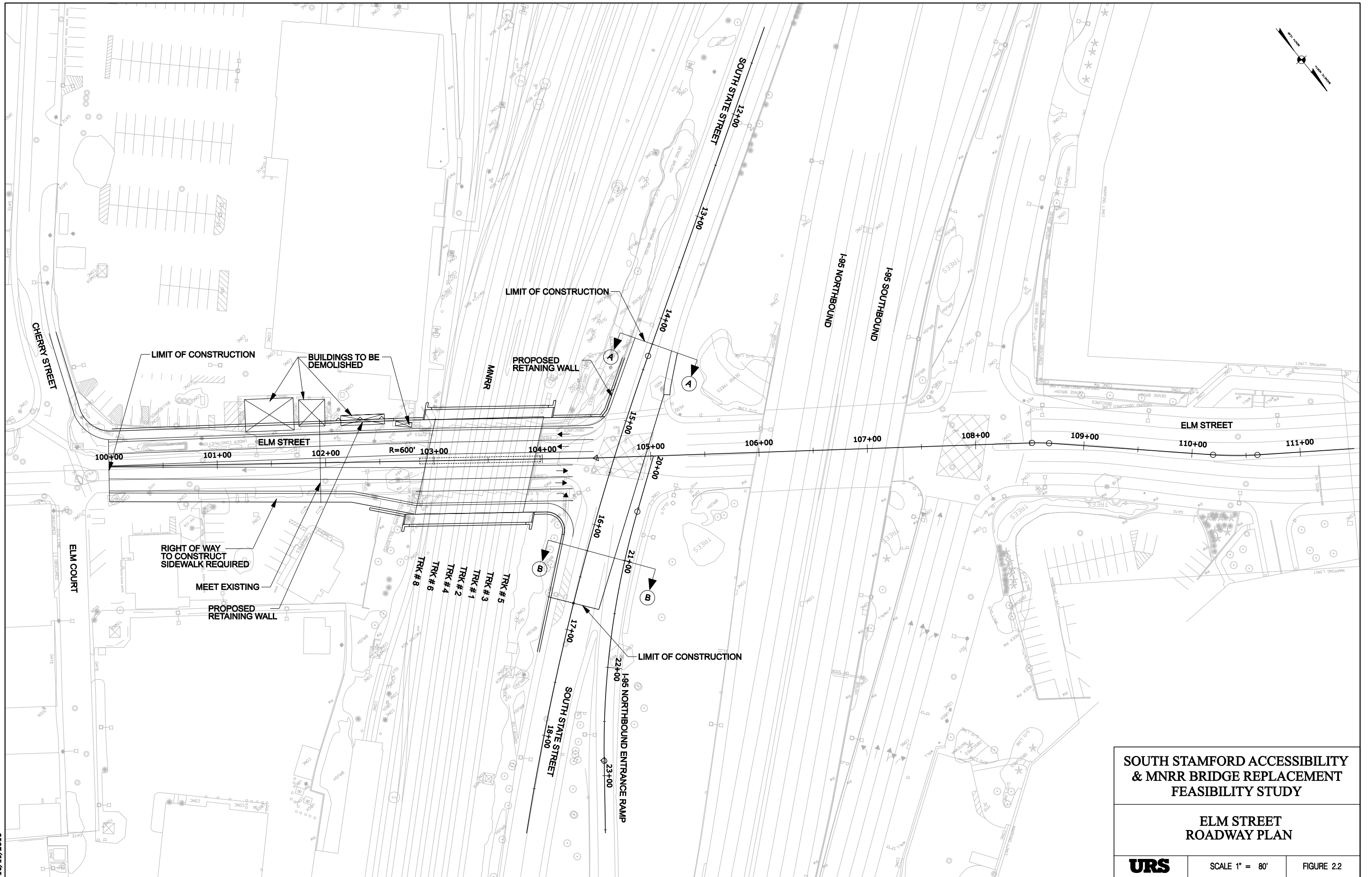

**SOUTH STAMFORD ACCESSIBILITY
& MNRR BRIDGE REPLACEMENT
FEASIBILITY STUDY**

**ELM STREET
ROADWAY PLAN**

URS

SCALE 1" = 80'

FIGURE 2.2

P:\CTDOT_projects\135-301\Highways\Phase-2\Elm\MSa_Contract_Sheet_Files\HW_MSH_135-301_PRO_Elm-2Span.dgn
10/19/2010

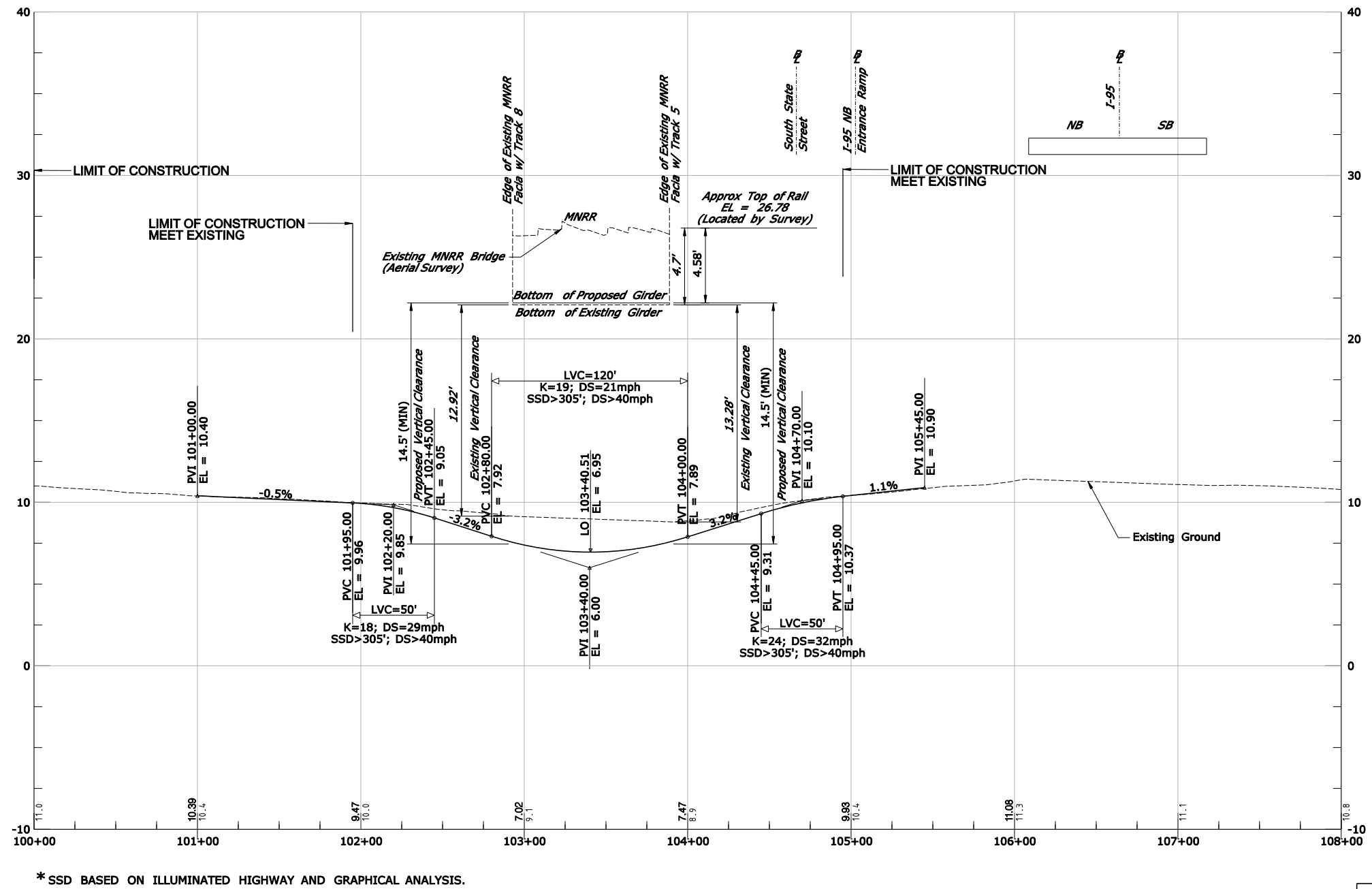

**SOUTH STAMFORD ACCESSIBILITY
& MNRR BRIDGE REPLACEMENT
FEASIBILITY STUDY**

**ELM STREET
ROADWAY PROFILE
(2 SPAN BRIDGE)**

URS

SCALE 1"=80'

FIGURE 2.3a

P:\CTDOT_projects\135-301\Highways\Phase-2\Elm\MSA-Contract_Sheet_Files\HW_MSH_135-301_PRO_SS-Elm.dgn
10/19/2010

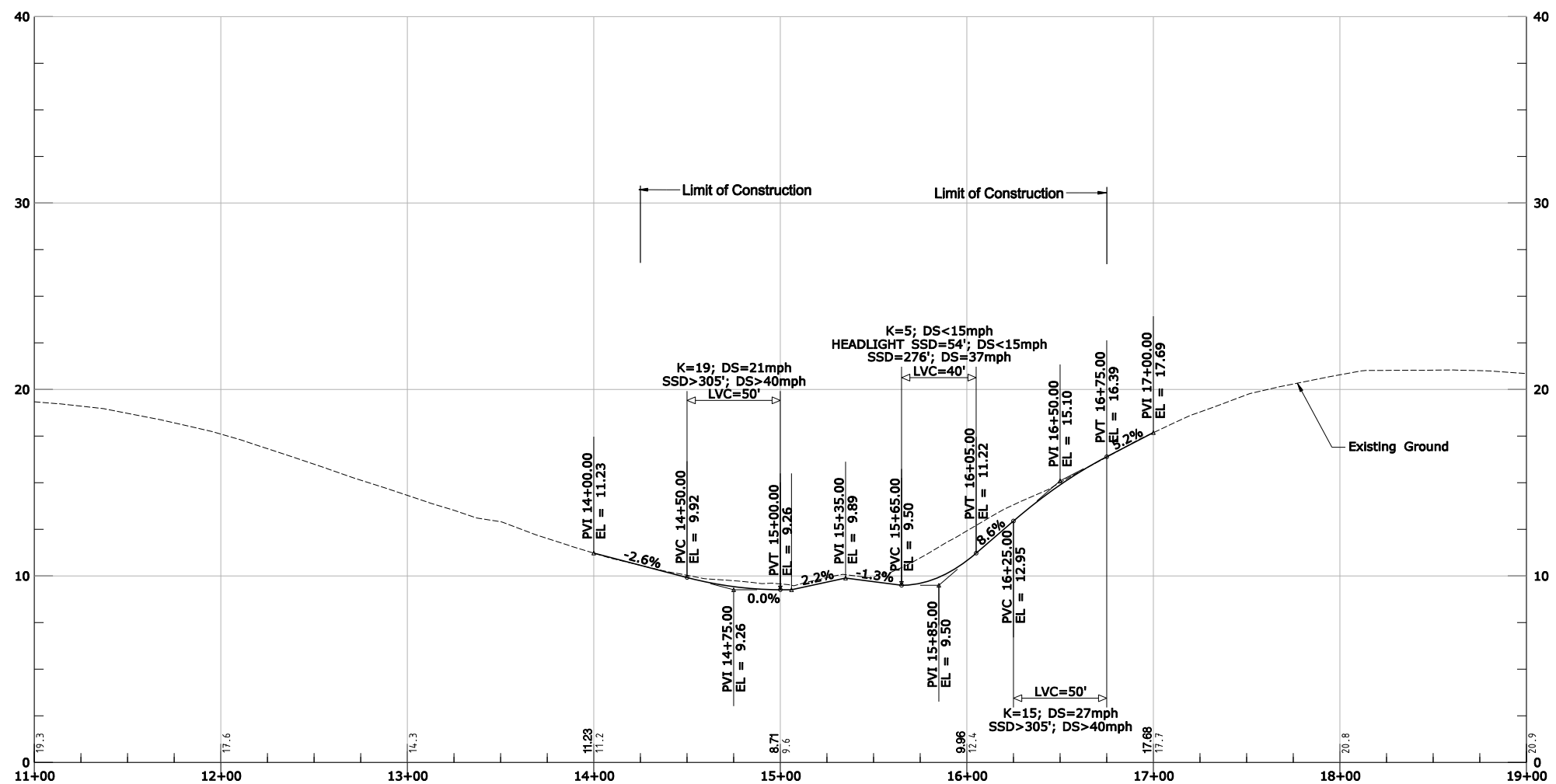

* SSD BASED ON ILLUMINATED HIGHWAY AND GRAPHICAL ANALYSIS.

SOUTH STAMFORD ACCESSIBILITY
& MNRR BRIDGE REPLACEMENT
FEASIBILITY STUDY

ELM STREET
SOUTH STATE STREET
PROFILE

URS

SCALE 1"=80'

FIGURE 2.3b

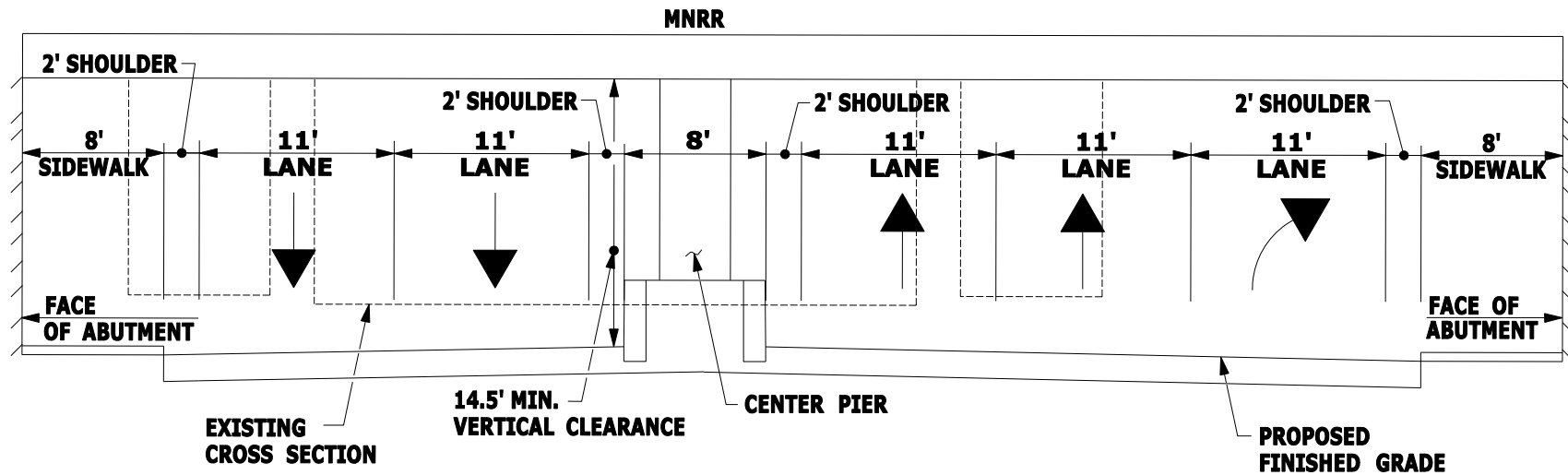

ELM STREET LOOKING NORTHBOUND

SOUTH STAMFORD ACCESSIBILITY
& MNRR BRIDGE REPLACEMENT
FEASIBILITY STUDY

ELM STREET
ROADWAY CROSS SECTION

URS

SCALE: 1"=10'

FIGURE 2.4

P:\CTDOT_projects\135-301\Highways\Phase-2\Elm\MSta-Contract_Sheet_Files\HW_MSH_135-301_XSECT_SState-Elm.dgn
10/19/2010

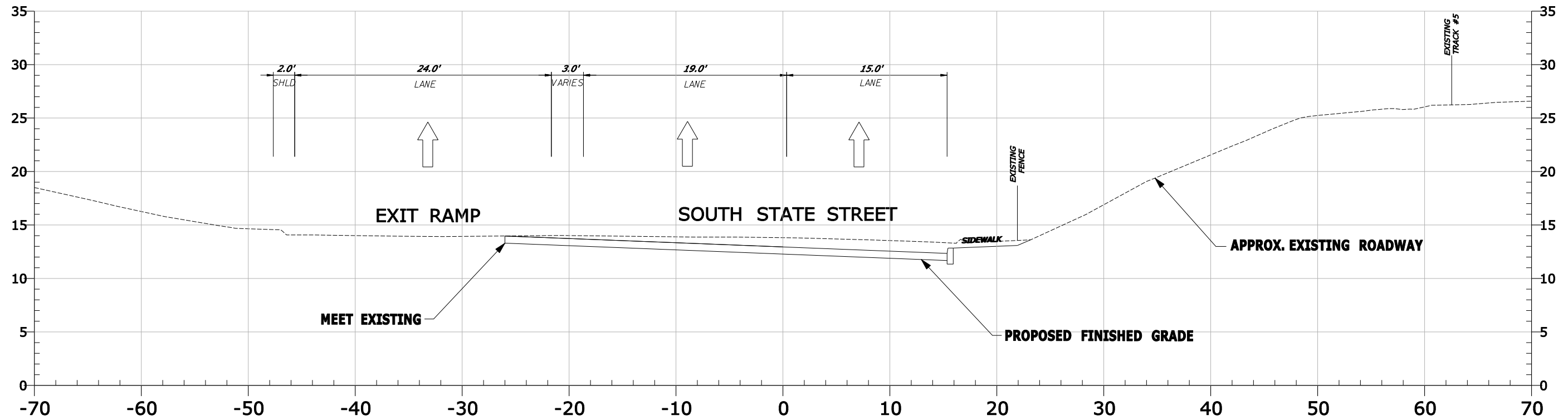

SECTION B-B
STA. 16+25.00

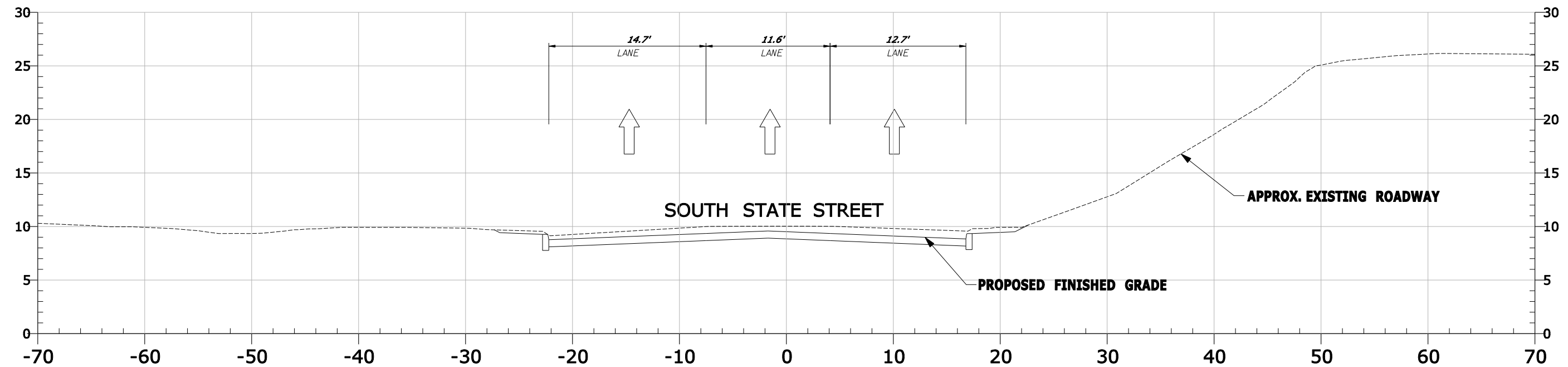

SECTION A-A
STA. 14+50.00

SOUTH STAMFORD ACCESSIBILITY
& MNRR BRIDGE REPLACEMENT
FEASIBILITY STUDY

CRITICAL CROSS SECTION
ELM - SOUTH STATE STREET

URS

SCALE 1"=10'

FIGURE 2.5

LEGEND:

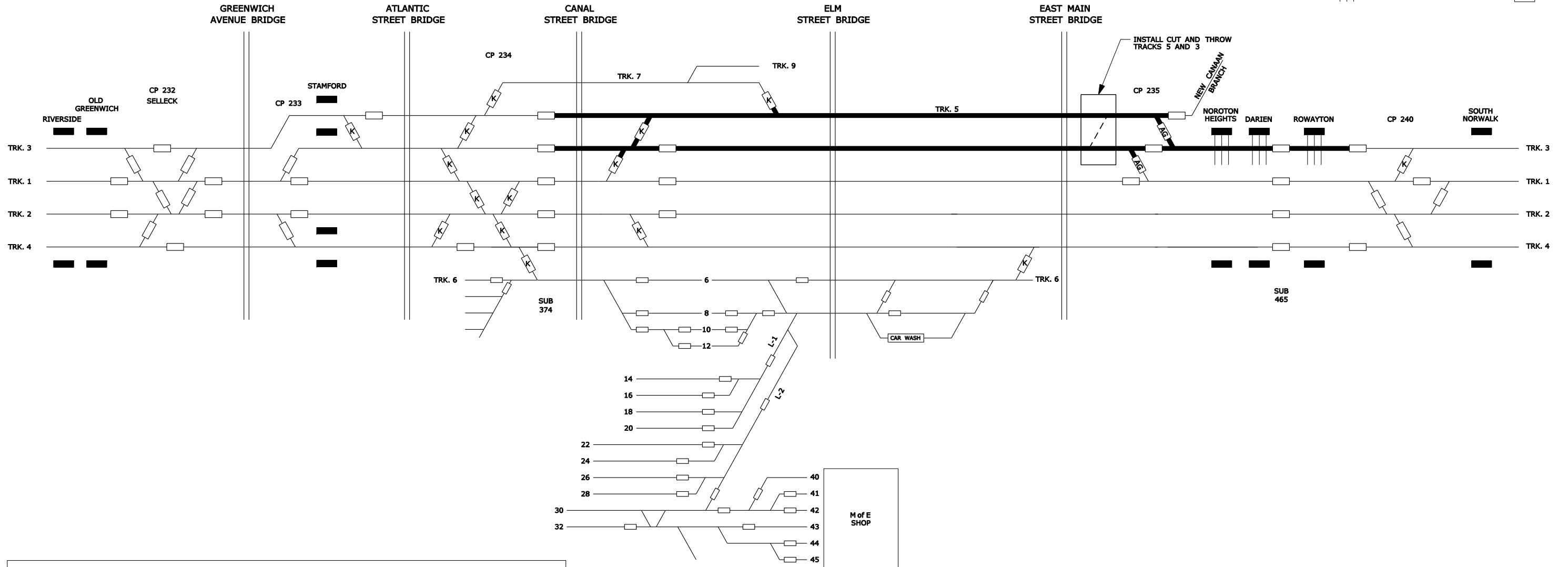
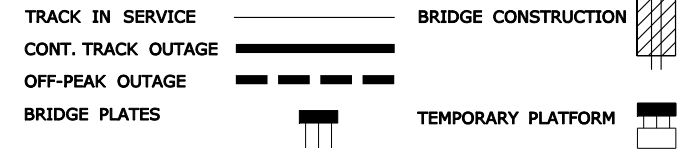

| STAGE | TASK | TRACK | TRACK OUTAGE |
|-------|---|-------|--|
| 1A | 1) INSTALL BRIDGE PLATES AT NORTON HEIGHTS, DARIEN, AND ROWAYTON. | 3 | OFF PEAK WEEKEND NIGHT OUTAGE |
| | 2) INSTALL CUT AND THROW TRACKS 5 AND 3 | | 5,3 CONTINUOUS TRACK OUTAGE (ONE WEEKEND ONLY) |

**SOUTH STAMFORD ACCESSIBILITY
& MNRR BRIDGE REPLACEMENT
FEASIBILITY STUDY**

**ELM STREET
CONSTRUCTION STAGING**

STAGE 1A

| | | |
|------------|---------------|-------------|
| URS | SCALE: N.T.S. | FIGURE 3.1a |
|------------|---------------|-------------|

LEGEND:

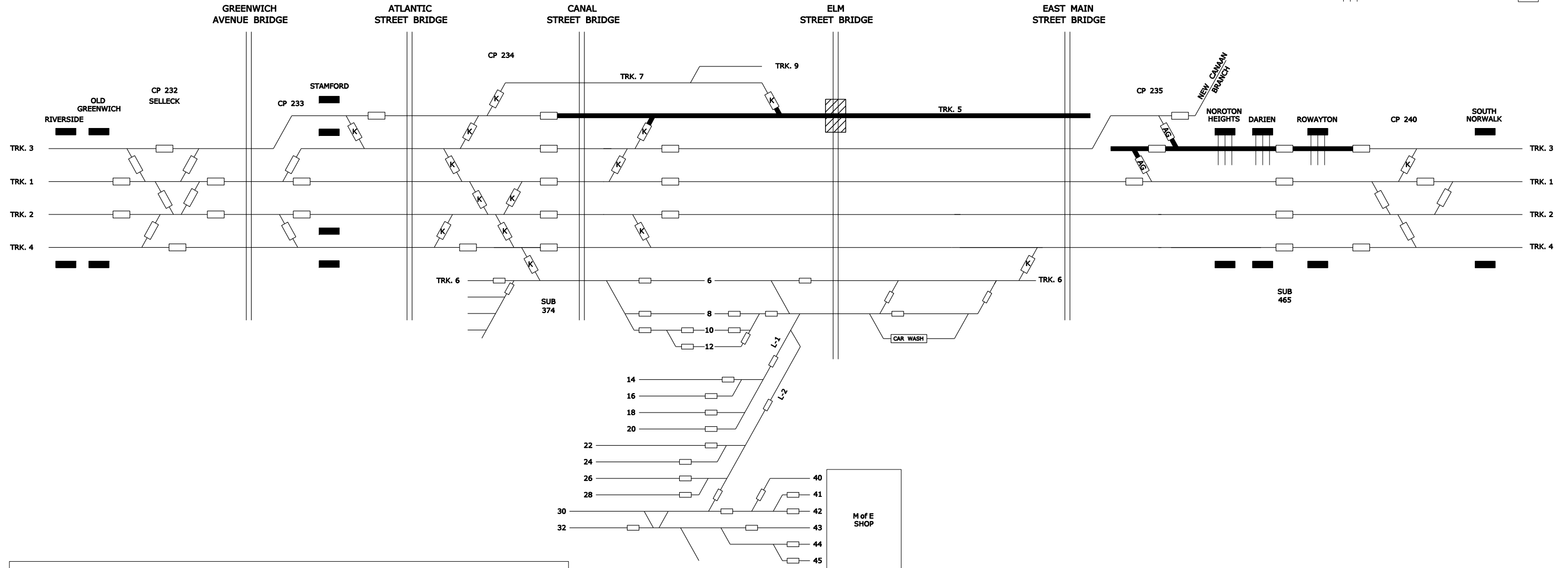
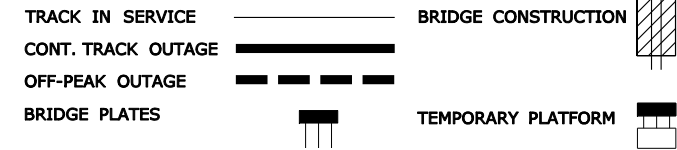

| STAGE | TASK | TRACK | TRACK OUTAGE |
|-------|---|-------|-------------------------|
| 1B | 1) REMOVE TRACK 5 AT ELM ST. 2) REMOVE EXISTING STEEL SUPERSTRUCTURE 3) INSTALL NEW ABUTMENTS 4) INSTALL NEW CENTER PIER 5) CUT BACK TOPS OF EXISTING ABUTMENTS 6) INSTALL NEW SUPERSTRUCTURE 7) INSTALL NEW TRACK 5 AT ELM ST. | 5,3 | CONTINUOUS TRACK OUTAGE |

**SOUTH STAMFORD ACCESSIBILITY
 & MNRR BRIDGE REPLACEMENT
 FEASIBILITY STUDY**

**ELM STREET
 CONSTRUCTION STAGING**

STAGE 1B

| | | |
|------------|---------------|-------------|
| URS | SCALE: N.T.S. | FIGURE 3.1b |
|------------|---------------|-------------|

LEGEND:

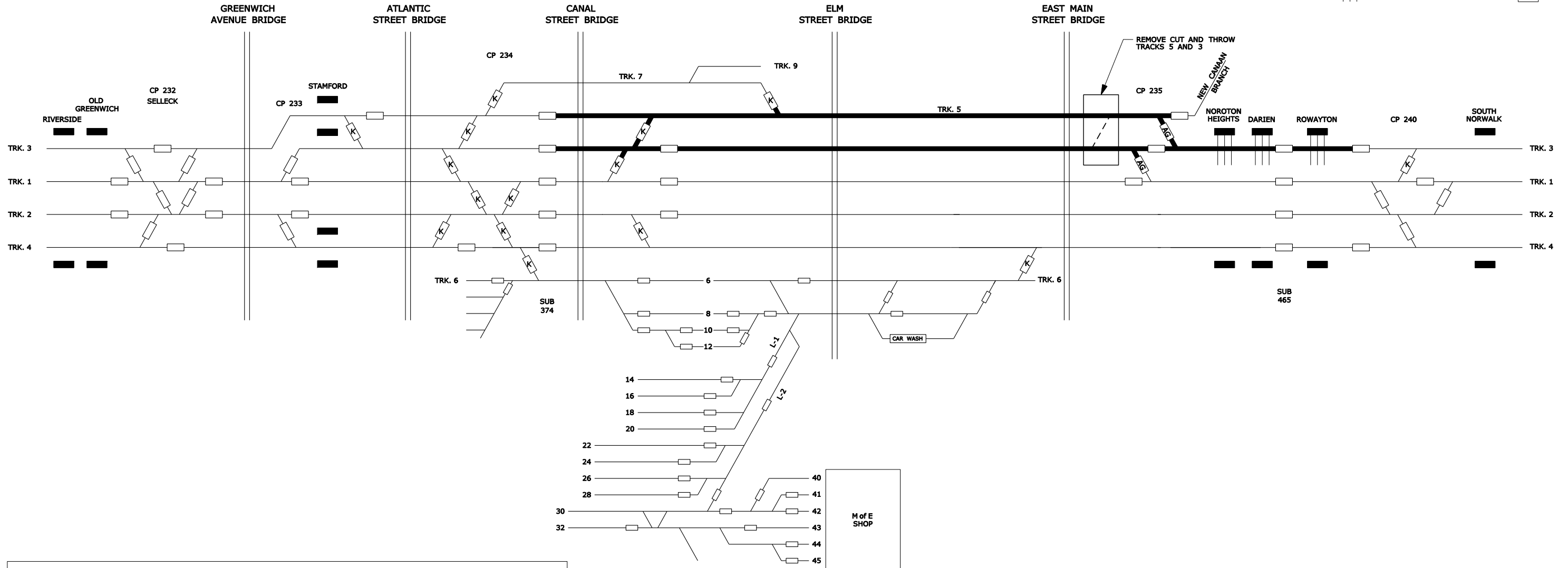
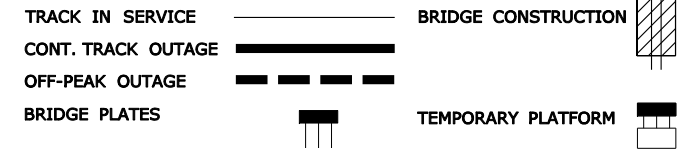

| STAGE | TASK | TRACK | TRACK OUTAGE |
|-------|--|-------|--|
| 1C | 1) REMOVE CUT AND THROW TRACKS 5 AND 3 | 3 | OFF PEAK WEEKEND NIGHT OUTAGE |
| | 2) REMOVE BRIDGE PLATES AT NORTON HEIGHTS, DARIEN, AND ROWAYTON. | 5,3 | CONTINUOUS TRACK OUTAGE (ONE WEEKEND ONLY) |

SOUTH STAMFORD ACCESSIBILITY & MNRR BRIDGE REPLACEMENT FEASIBILITY STUDY

ELM STREET CONSTRUCTION STAGING

STAGE 1C



SCALE: N.T.S.

FIGURE 3.1c

LEGEND:

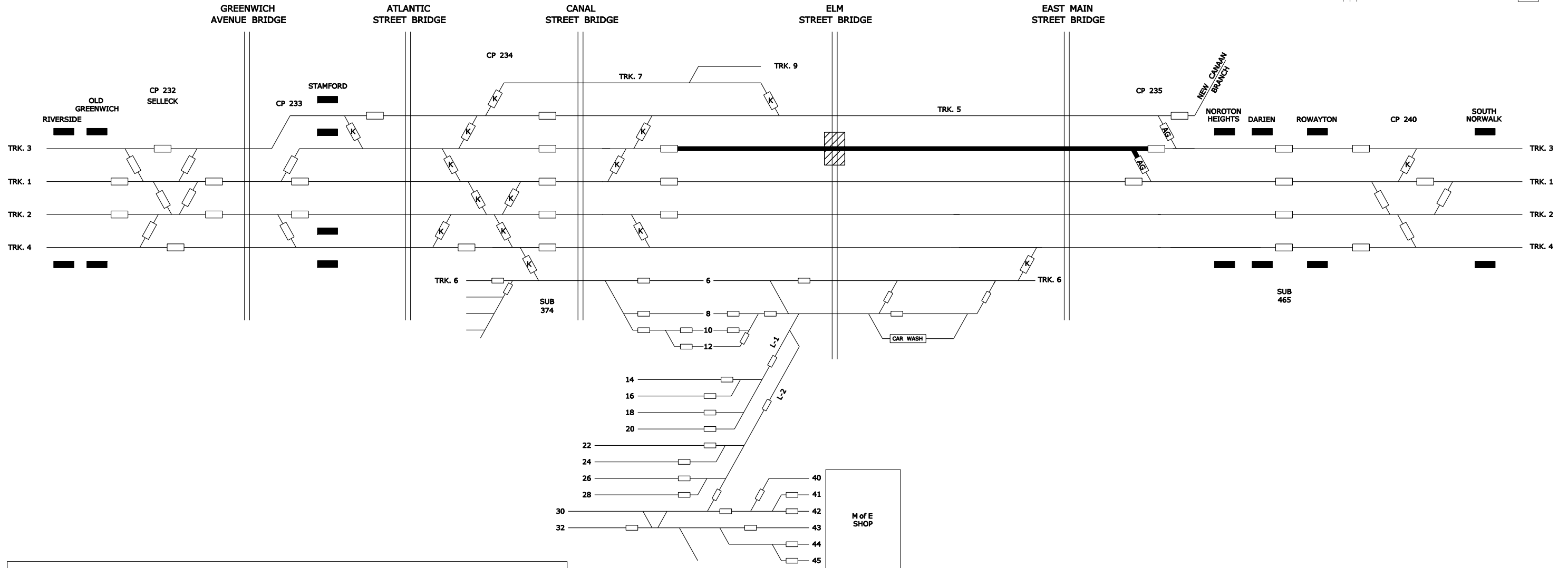
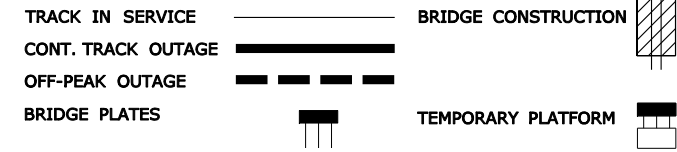

| STAGE | TASK | TRACK | TRACK OUTAGE |
|-------|---|-------|-------------------------|
| 2 | 1) REMOVE TRACK 3 AT ELM ST. 2) REMOVE EXISTING STEEL SUPERSTRUCTURE 3) INSTALL NEW ABUTMENTS 4) INSTALL NEW CENTER PIER 5) CUT BACK TOPS OF EXISTING ABUTMENTS 6) INSTALL NEW SUPERSTRUCTURE 7) INSTALL NEW TRACK 3 AT ELM ST. | 3 | CONTINUOUS TRACK OUTAGE |

**SOUTH STAMFORD ACCESSIBILITY
& MNRR BRIDGE REPLACEMENT
FEASIBILITY STUDY**

**ELM STREET
CONSTRUCTION STAGING**

STAGE 2

| | | |
|------------|---------------|-------------|
| URS | SCALE: N.T.S. | FIGURE 3.1d |
|------------|---------------|-------------|

LEGEND:

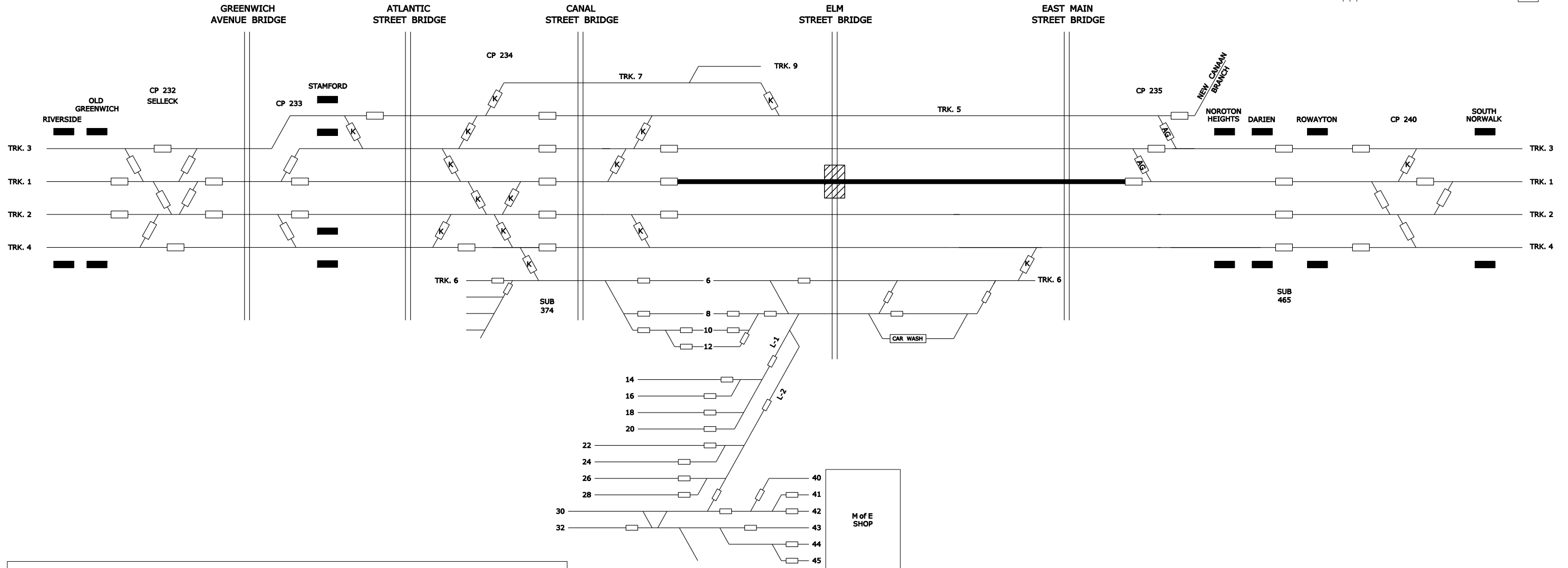
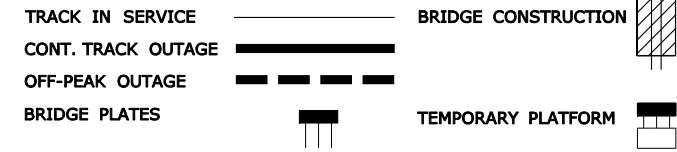

| STAGE | TASK | TRACK | TRACK OUTAGE |
|-------|---|-------|-------------------------|
| 3 | 1) REMOVE TRACK 1 AT ELM ST. 2) REMOVE EXISTING STEEL SUPERSTRUCTURE 3) INSTALL NEW ABUTMENTS 4) INSTALL NEW CENTER PIER 5) CUT BACK TOPS OF EXISTING ABUTMENTS 6) INSTALL NEW SUPERSTRUCTURE 7) INSTALL NEW TRACK 1 AT ELM ST. | 1 | CONTINUOUS TRACK OUTAGE |

**SOUTH STAMFORD ACCESSIBILITY
& MNRR BRIDGE REPLACEMENT
FEASIBILITY STUDY**

**ELM STREET
CONSTRUCTION STAGING**

STAGE 3

| | | |
|------------|---------------|-------------|
| URS | SCALE: N.T.S. | FIGURE 3.1e |
|------------|---------------|-------------|

LEGEND:

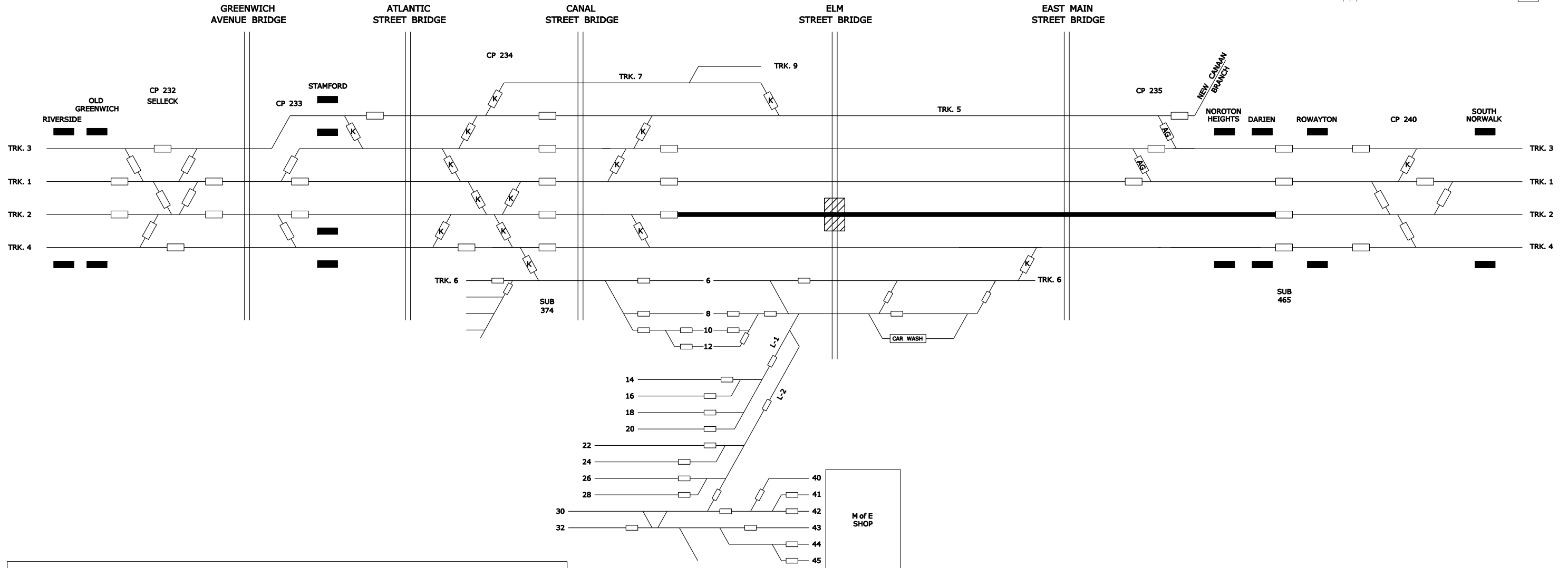
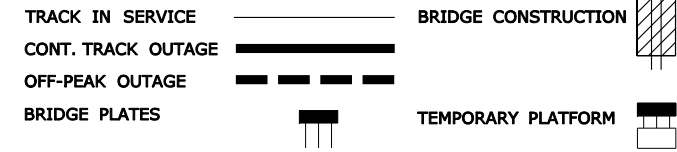

| STAGE | TASK | TRACK | TRACK OUTAGE |
|-------|---|-------|-------------------------|
| 4 | 1) REMOVE TRACK 2 AT ELM ST. 2) REMOVE EXISTING STEEL SUPERSTRUCTURE 3) INSTALL NEW ABUTMENTS 4) INSTALL NEW CENTER PIER 5) CUT BACK TOPS OF EXISTING ABUTMENTS 6) INSTALL NEW SUPERSTRUCTURE 7) INSTALL NEW TRACK 2 AT ELM ST. | 2 | CONTINUOUS TRACK OUTAGE |

**SOUTH STAMFORD ACCESSIBILITY
& MNRR BRIDGE REPLACEMENT
FEASIBILITY STUDY**

**ELM STREET
CONSTRUCTION STAGING**

STAGE 4

| | | |
|------------|---------------|-------------|
| URS | SCALE: N.T.S. | FIGURE 3.1f |
|------------|---------------|-------------|

LEGEND:

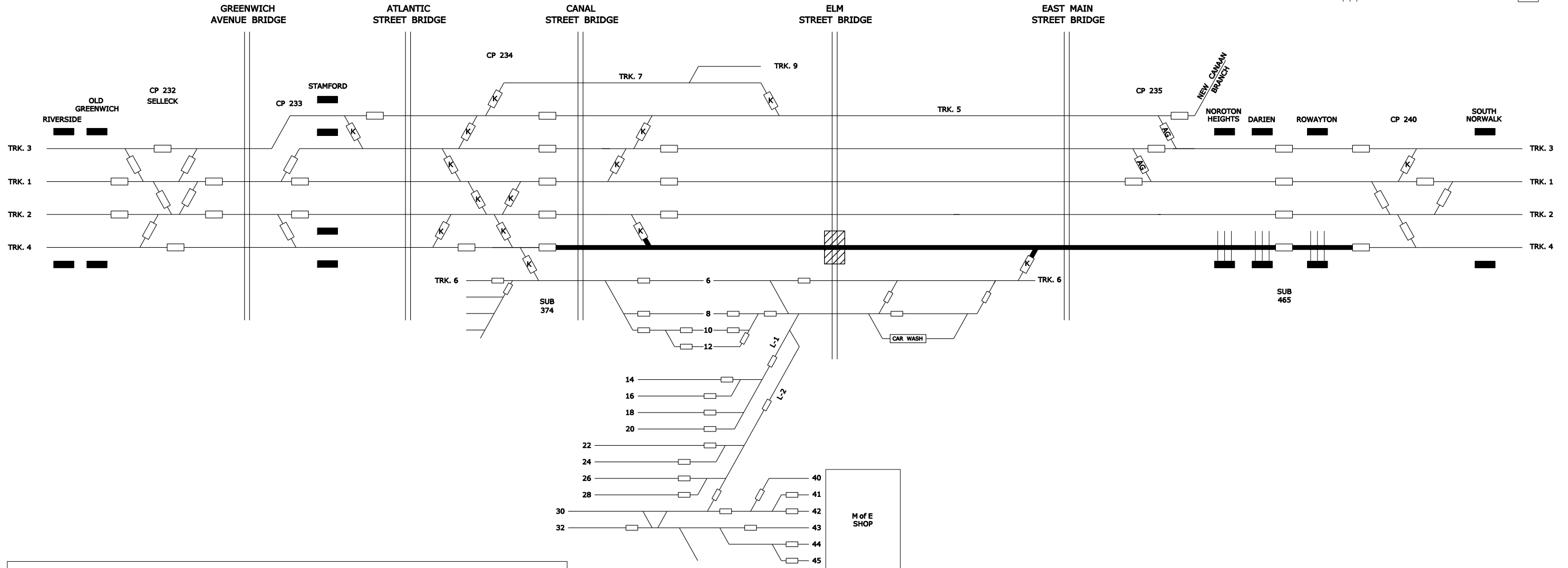
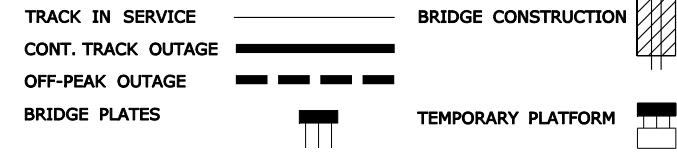

| STAGE | TASK | TRACK | TRACK OUTAGE |
|-------|--|-------|-------------------------------|
| 5 | 1) INSTALL BRIDGE PLATES AT NORTON HEIGHTS, DARIEN, AND ROWAYTON | 4 | OFF PEAK WEEKEND NIGHT OUTAGE |
| | 2) REMOVE TRACK 4 AT ELM ST. | 4 | CONTINUOUS TRACK OUTAGE |
| | 3) REMOVE EXISTING STEEL SUPERSTRUCTURE | | |
| | 4) INSTALL NEW ABUTMENTS | | |
| | 5) INSTALL NEW CENTER PIER | | |
| | 6) CUT BACK TOPS OF EXISTING ABUTMENTS | | |
| | 7) INSTALL NEW SUPERSTRUCTURE | | |
| | 8) INSTALL NEW TRACK 4 AT ELM ST. | | |
| | 9) REMOVE ALL BRIDGE PLATES | 4 | OFF PEAK WEEKEND NIGHT OUTAGE |

SOUTH STAMFORD ACCESSIBILITY & MNRR BRIDGE REPLACEMENT FEASIBILITY STUDY

ELM STREET CONSTRUCTION STAGING

STAGE 5

URS

SCALE: N.T.S.

FIGURE 3.1g

LEGEND:

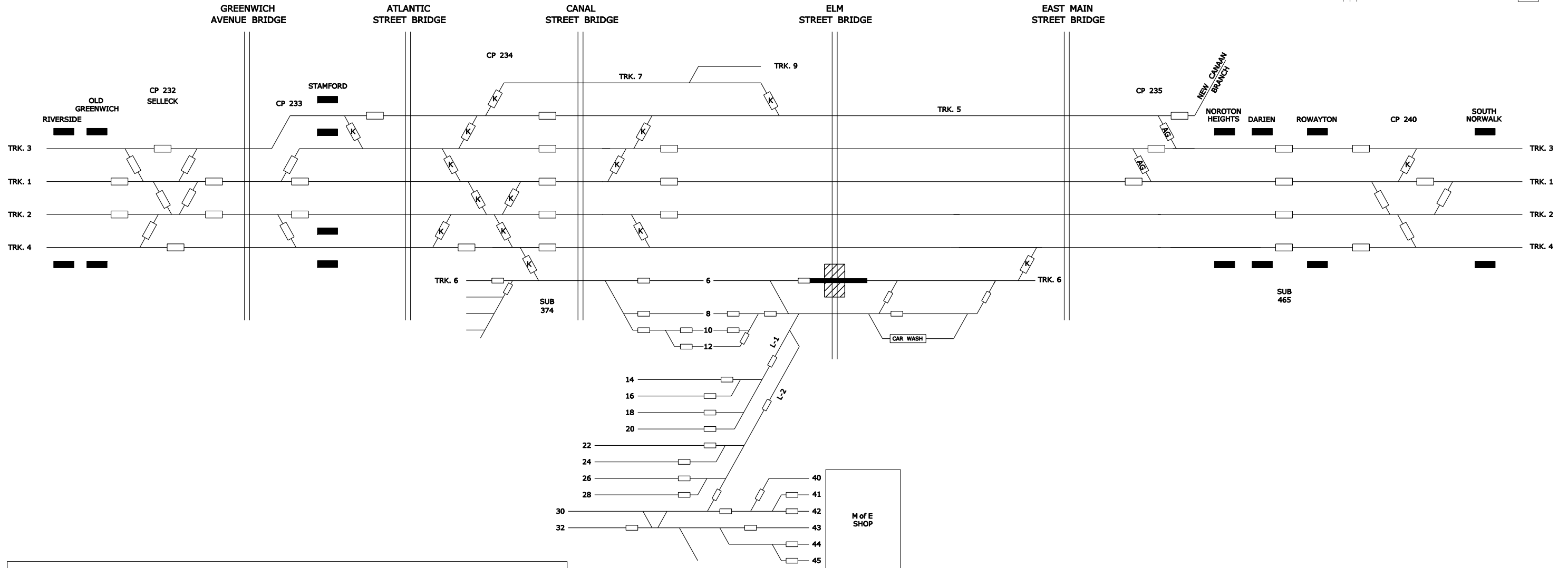
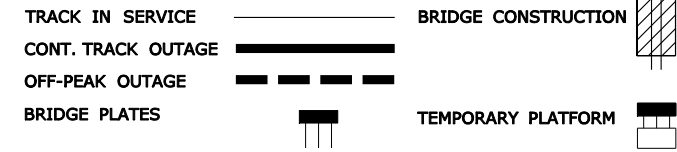

| STAGE | TASK | TRACK | TRACK OUTAGE |
|-------|---|-------|-------------------------|
| 6 | 1) REMOVE TRACK 6 AT ELM ST. 2) REMOVE EXISTING STEEL SUPERSTRUCTURE 3) INSTALL NEW ABUTMENTS 4) INSTALL NEW CENTER PIER 5) CUT BACK TOPS OF EXISTING ABUTMENTS 6) INSTALL NEW SUPERSTRUCTURE 7) INSTALL NEW TRACK 6 AT ELM ST. | 6 | CONTINUOUS TRACK OUTAGE |

**SOUTH STAMFORD ACCESSIBILITY
& MNRR BRIDGE REPLACEMENT
FEASIBILITY STUDY**

**ELM STREET
CONSTRUCTION STAGING**

STAGE 6

| | | |
|------------|---------------|-------------|
| URS | SCALE: N.T.S. | FIGURE 3.1h |
|------------|---------------|-------------|

LEGEND:

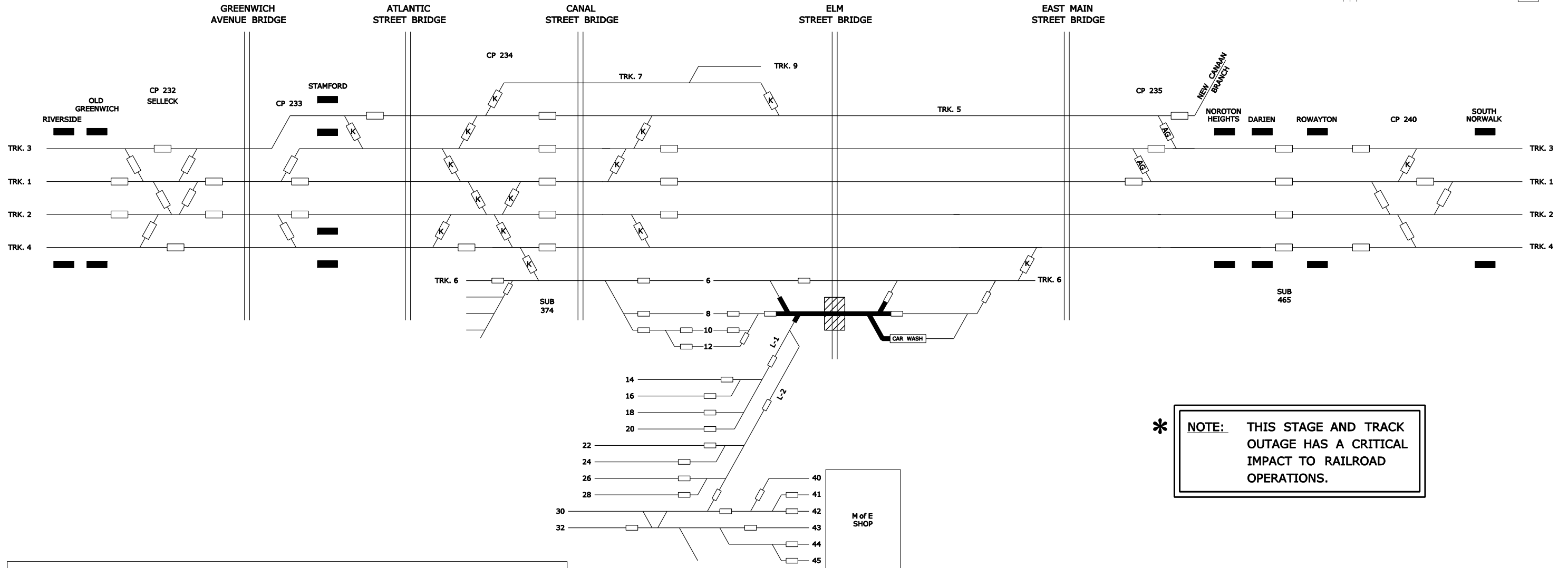
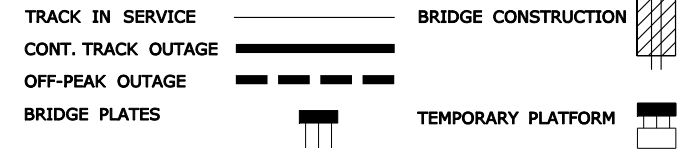

*** NOTE:** THIS STAGE AND TRACK OUTAGE HAS A CRITICAL IMPACT TO RAILROAD OPERATIONS.

| STAGE | TASK | TRACK | TRACK OUTAGE |
|-------|---|-------|---------------------------|
| 7 | 1) REMOVE TRACK 8 AT ELM ST. 2) REMOVE EXISTING STEEL SUPERSTRUCTURE 3) INSTALL NEW ABUTMENTS 4) INSTALL NEW CENTER PIER 5) CUT BACK TOPS OF EXISTING ABUTMENTS 6) INSTALL NEW SUPERSTRUCTURE 7) INSTALL NEW TRACK 8 AT ELM ST. | 8 | CONTINUOUS TRACK OUTAGE * |

**SOUTH STAMFORD ACCESSIBILITY
& MNRR BRIDGE REPLACEMENT
FEASIBILITY STUDY**

**ELM STREET
CONSTRUCTION STAGING**

STAGE 7

| | | |
|------------|---------------|-------------|
| URS | SCALE: N.T.S. | FIGURE 3.1i |
|------------|---------------|-------------|

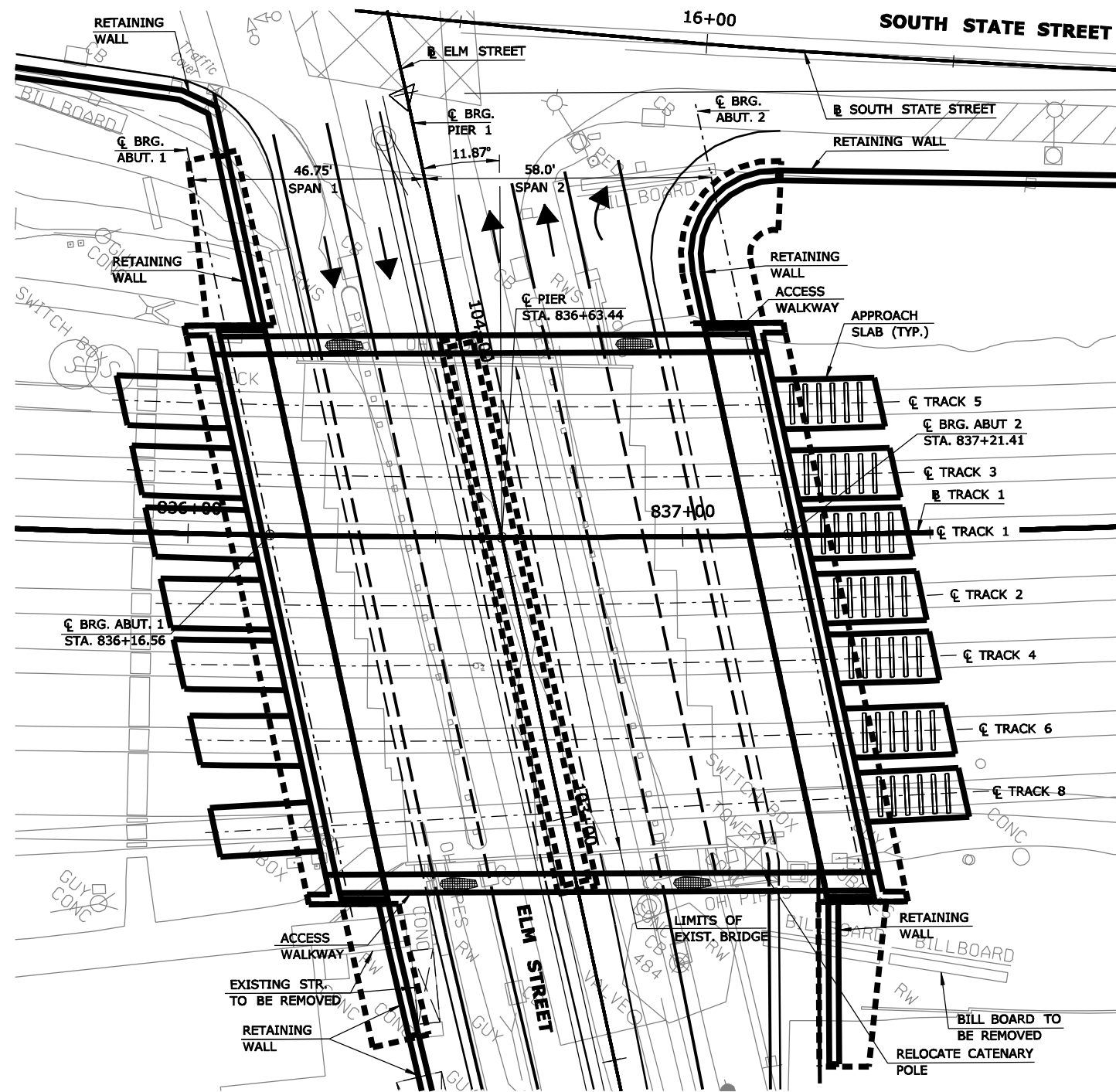

PROPOSED PLAN
SCALE: 1" = 30'

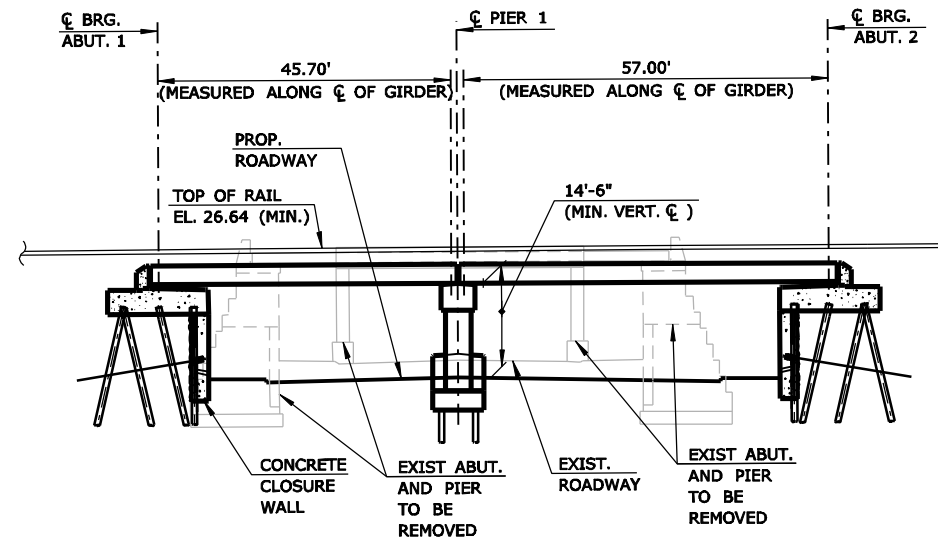

ELEVATION
SCALE: 1" = 30'

**SOUTH STAMFORD ACCESSIBILITY
& MNRR BRIDGE REPLACEMENT
FEASIBILITY STUDY**

**ELM STREET
GENERAL PLAN AND ELEVATION
(2-SPAN ALTERNATIVE)**

URS

SCALE AS NOTED

FIGURE 4.1

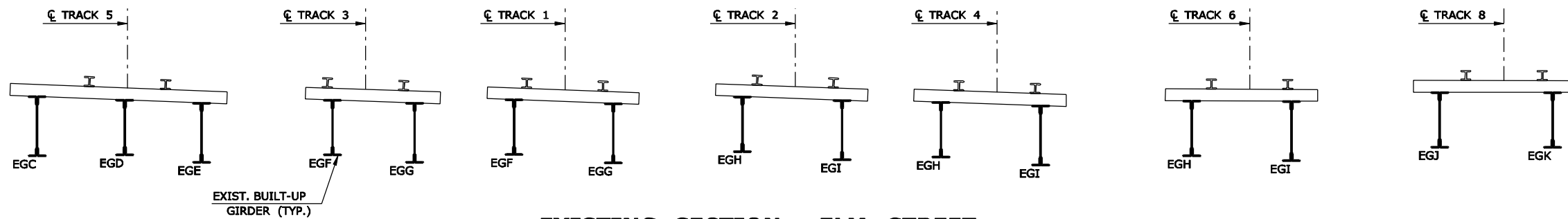

EXISTING SECTION - ELM STREET

SCALE: 3/8" = 1'-0"

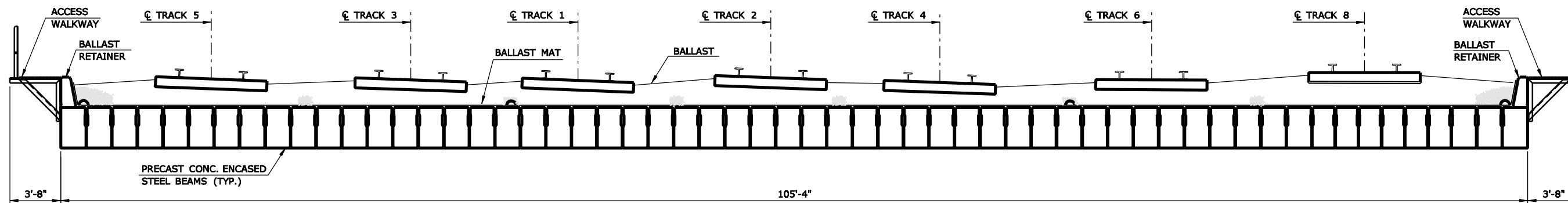

FINAL SECTION - PRECAST MULTIPLE CONCRETE ENCASED STEEL GIRDERS

SCALE: 3/8" = 1'-0"

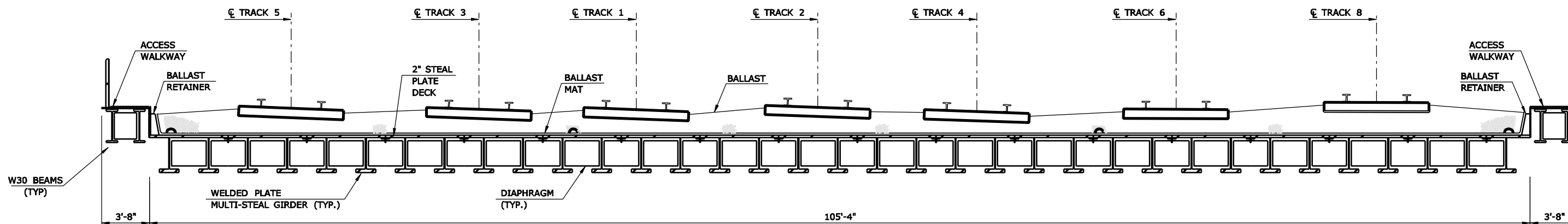

FINAL SECTION - MULTI-STEEL GIRDERS

SCALE: 3/8" = 1'-0"

SOUTH STAMFORD ACCESSIBILITY
& MNRR BRIDGE REPLACEMENT
FEASIBILITY STUDY

ELM STREET
BRIDGE TYPICAL SECTION

URS

SCALE AS NOTED

FIGURE 4.2

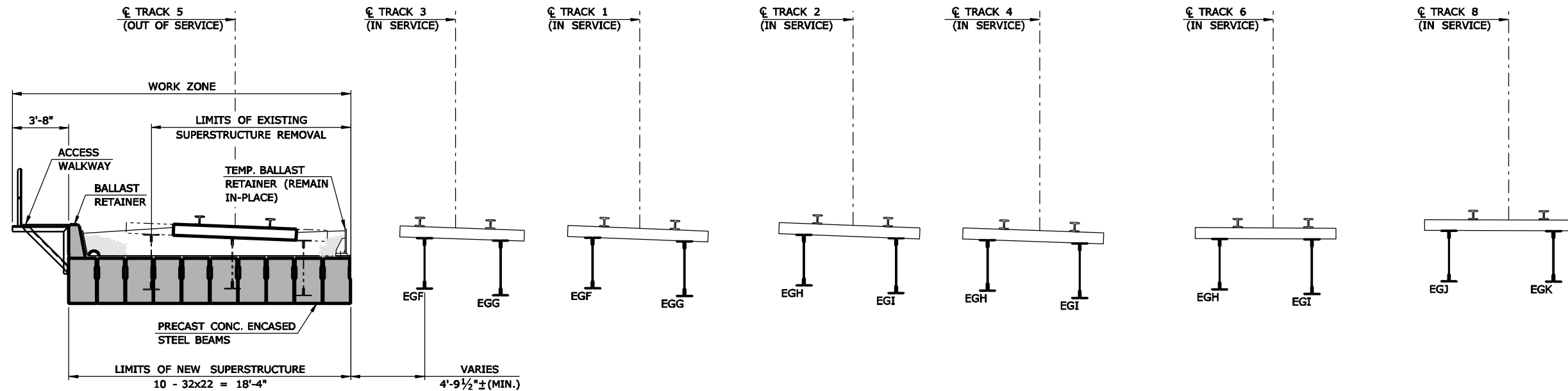

STAGE 1

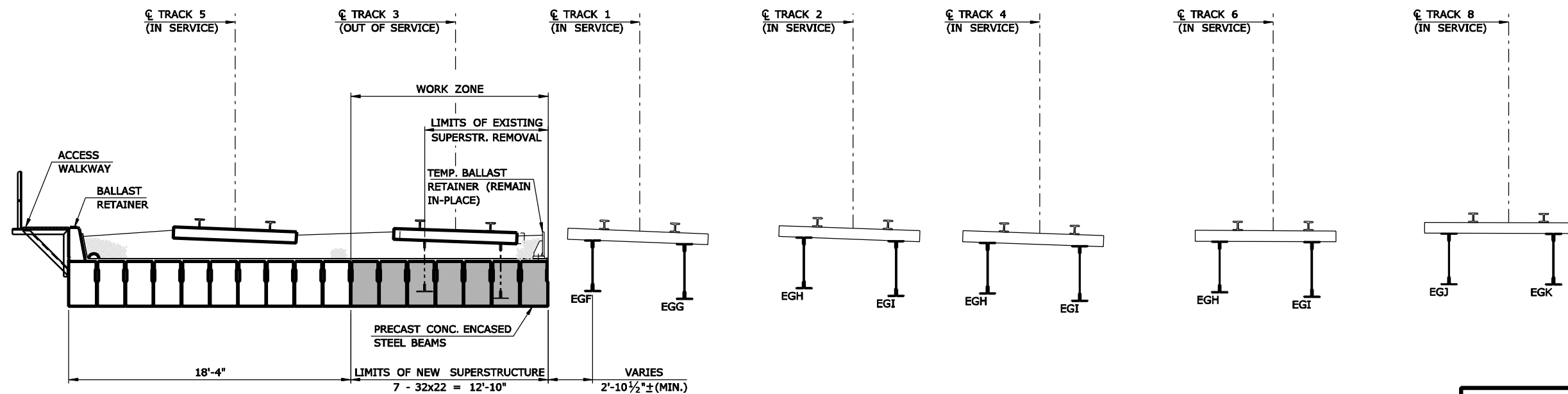

STAGE 2

STAGE CONSTRUCTION - PRECAST MULTIPLE CONCRETE ENCASED STEEL GIRDERS

SCALE: 1/8" = 1'-0"

SOUTH STAMFORD ACCESSIBILITY
& MNRR BRIDGE REPLACEMENT
FEASIBILITY STUDY

ELM STREET
CONSTRUCTION STAGE 1 & 2

URS

SCALE AS NOTED

FIGURE 4.3A

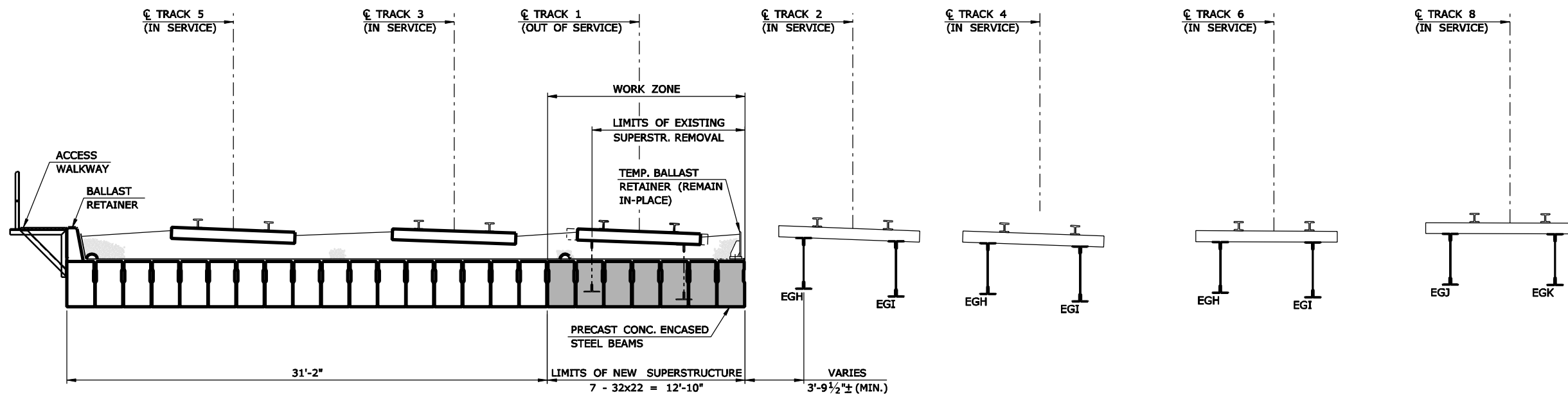

STAGE 3

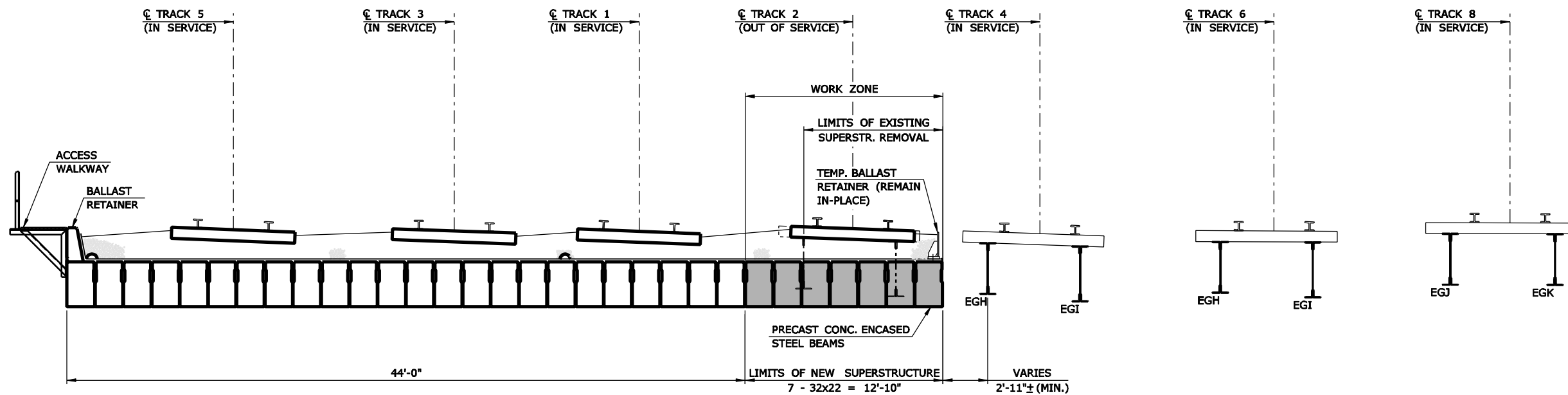

STAGE 4

STAGE CONSTRUCTION - PRECAST MULTIPLE CONCRETE ENCASED STEEL GIRDERS

SCALE: 1/8" = 1'-0"

SOUTH STAMFORD ACCESSIBILITY
& MNRR BRIDGE REPLACEMENT
FEASIBILITY STUDY

ELM STREET
CONSTRUCTION STAGE 3 & 4

URS

SCALE AS NOTED

FIGURE 4.3B

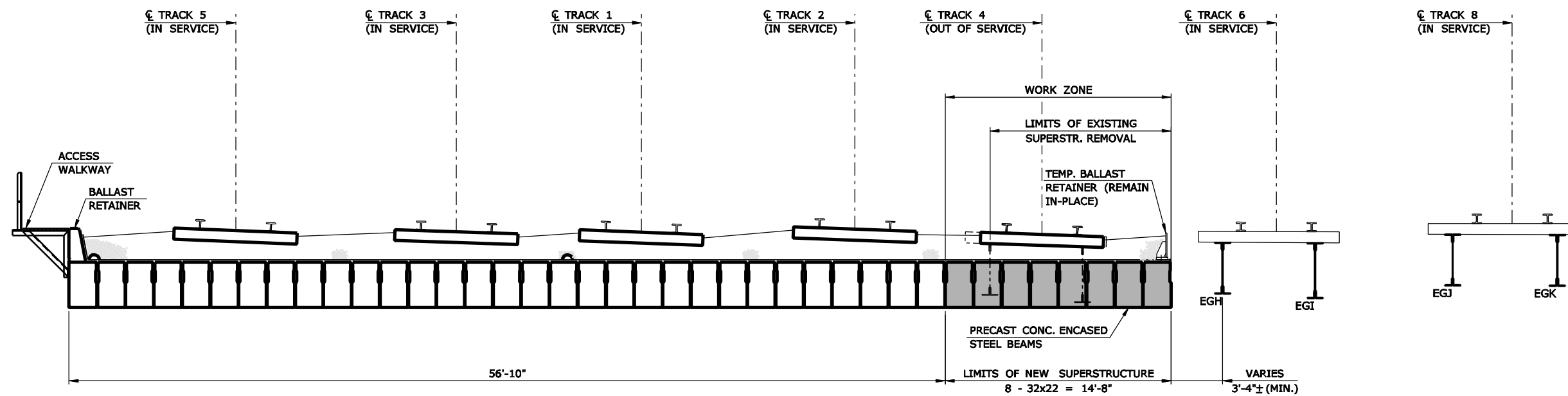

STAGE 5

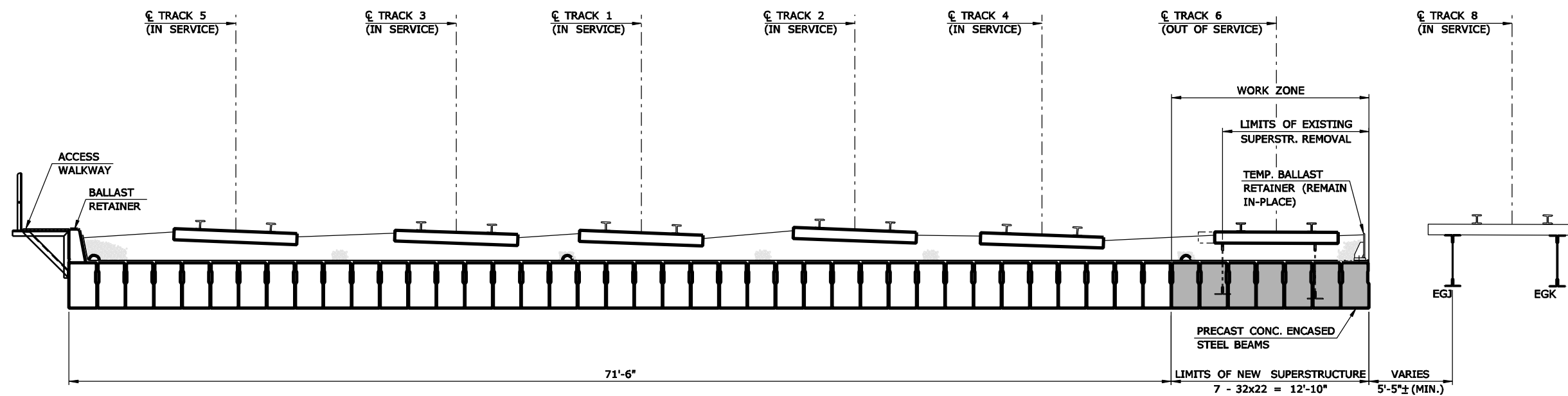

STAGE 6

STAGE CONSTRUCTION - PRECAST MULTIPLE CONCRETE ENCASED STEEL GIRDERS

SCALE: 1/8" = 1'-0"

SOUTH STAMFORD ACCESSIBILITY
& MNRR BRIDGE REPLACEMENT
FEASIBILITY STUDY

ELM STREET
CONSTRUCTION STAGE 5 & 6

URS

SCALE AS NOTED

FIGURE 4.3C

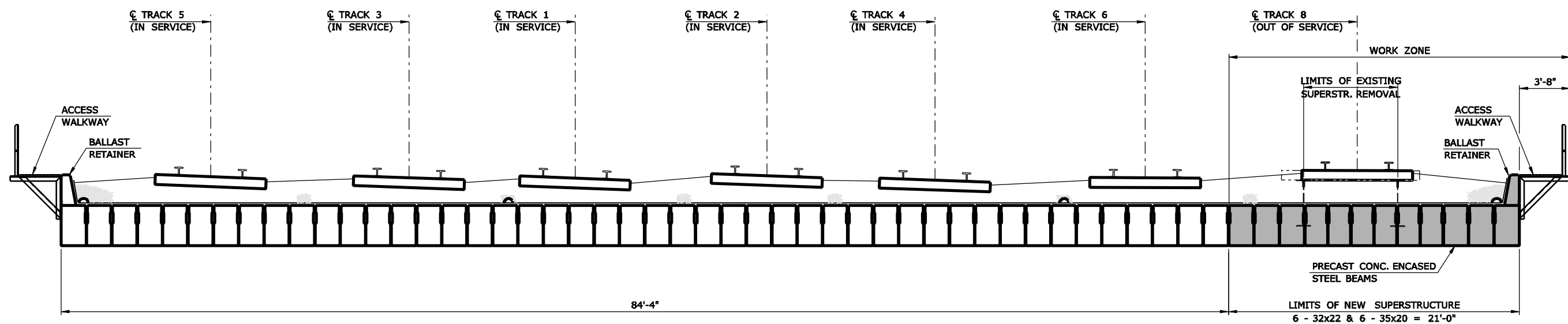

STAGE 7

STAGE CONSTRUCTION - PRECAST MULTIPLE CONCRETE ENCASED STEEL GIRDERS

SCALE: 1/8" = 1'-0"

SOUTH STAMFORD ACCESSIBILITY
& MNRR BRIDGE REPLACEMENT
FEASIBILITY STUDY

ELM STREET
CONSTRUCTION STAGE 7

URS

SCALE AS NOTED

FIGURE 4.3D

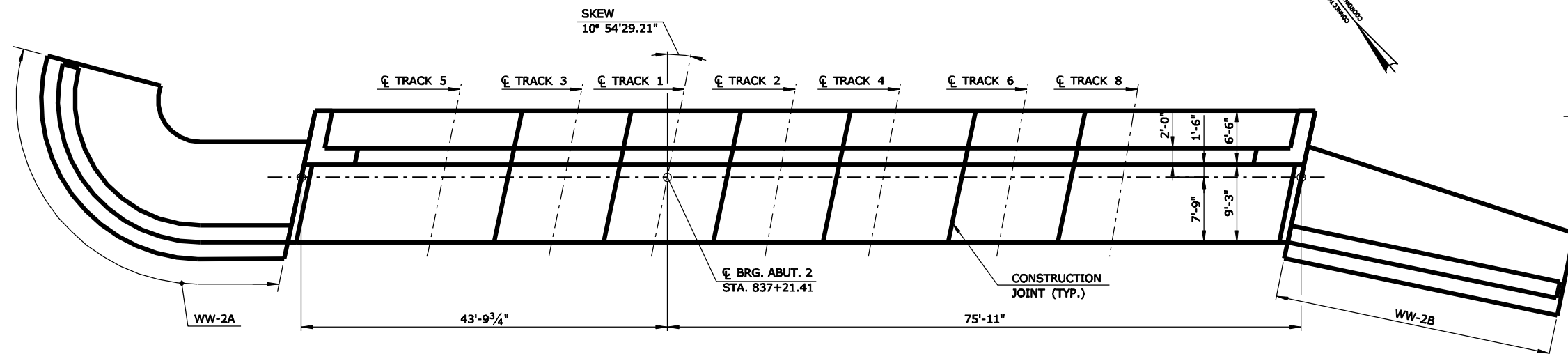

ABUTMENT 2 PLAN
SCALE: 1/16" = 1'-0"

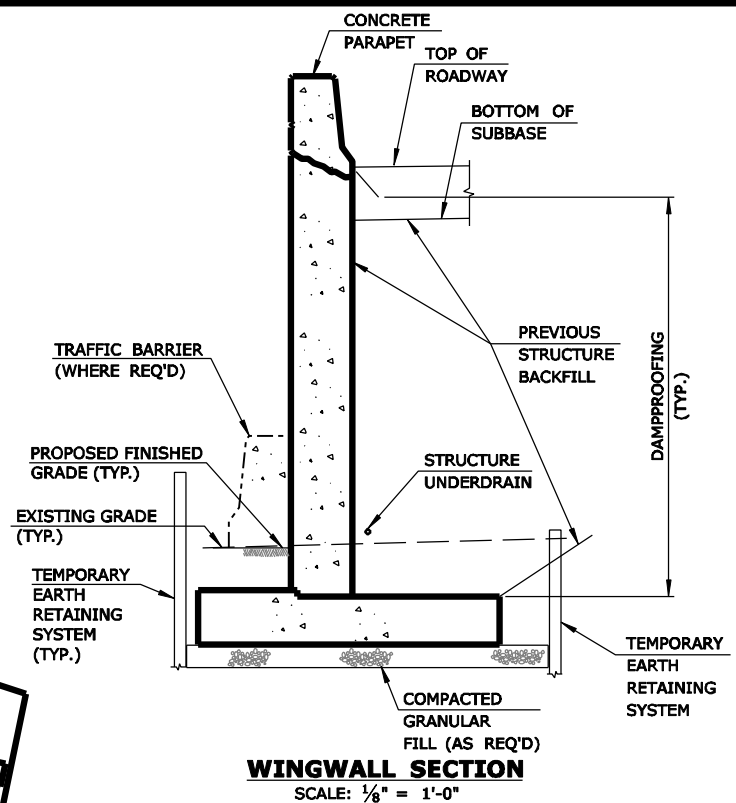

WINGWALL SECTION
SCALE: 1/8" = 1'-0"

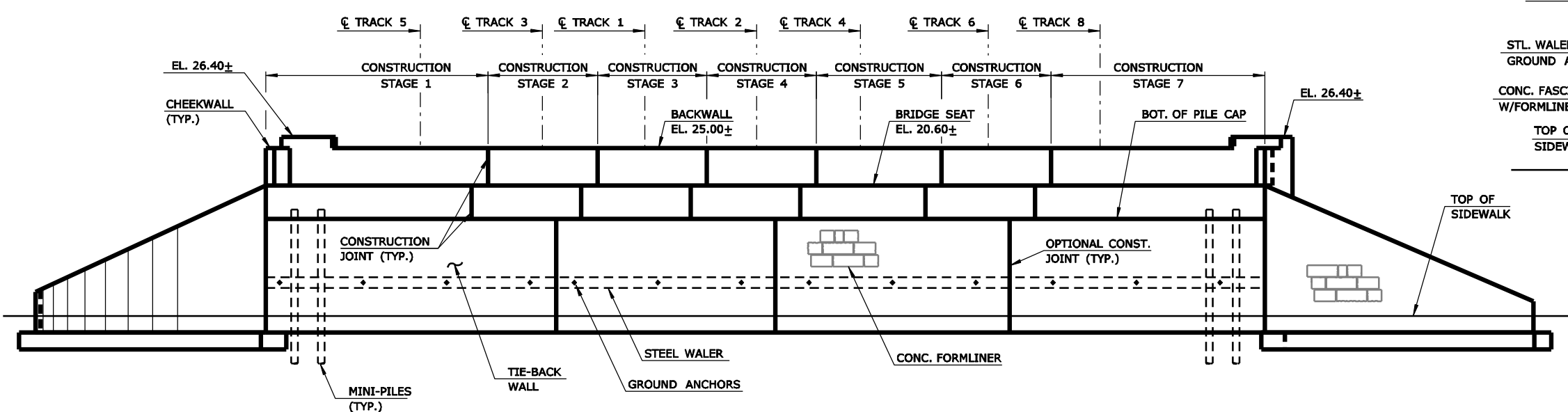

ABUTMENT 2 ELEVATION PLAN
SCALE: 1/16" = 1'-0"

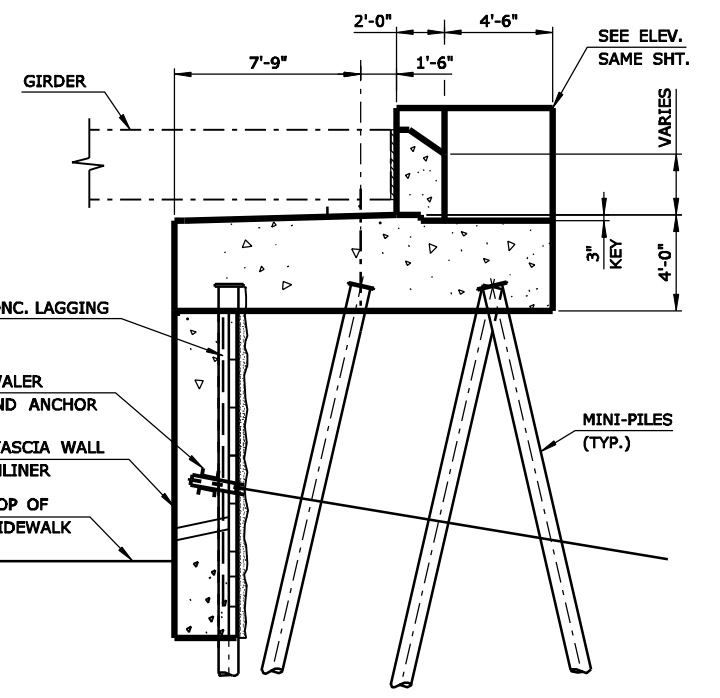

ABUTMENT SECTION
SCALE: 1/8" = 1'-0"

**SOUTH STAMFORD ACCESSIBILITY
& MNRR BRIDGE REPLACEMENT
FEASIBILITY STUDY**

**ELM STREET
ABUTMENT PLAN**

URS

SCALE AS NOTED

FIGURE 4.4

FILES 2017

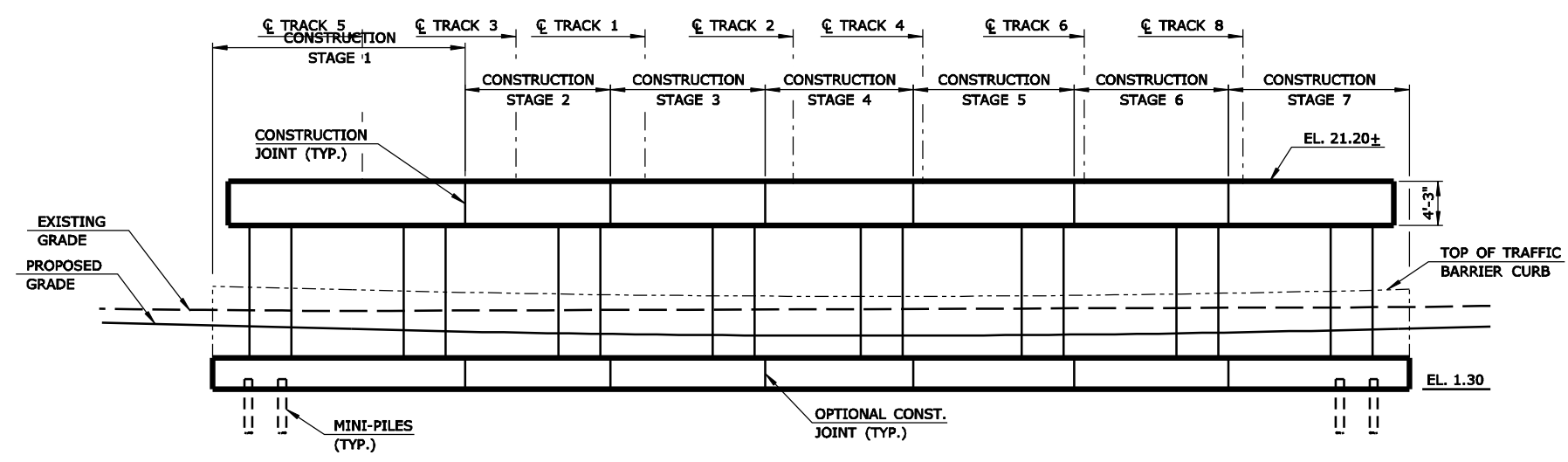
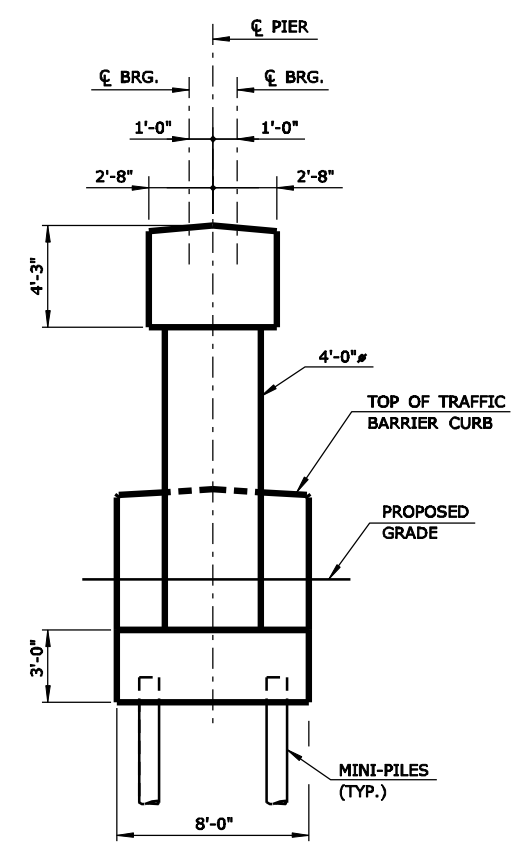
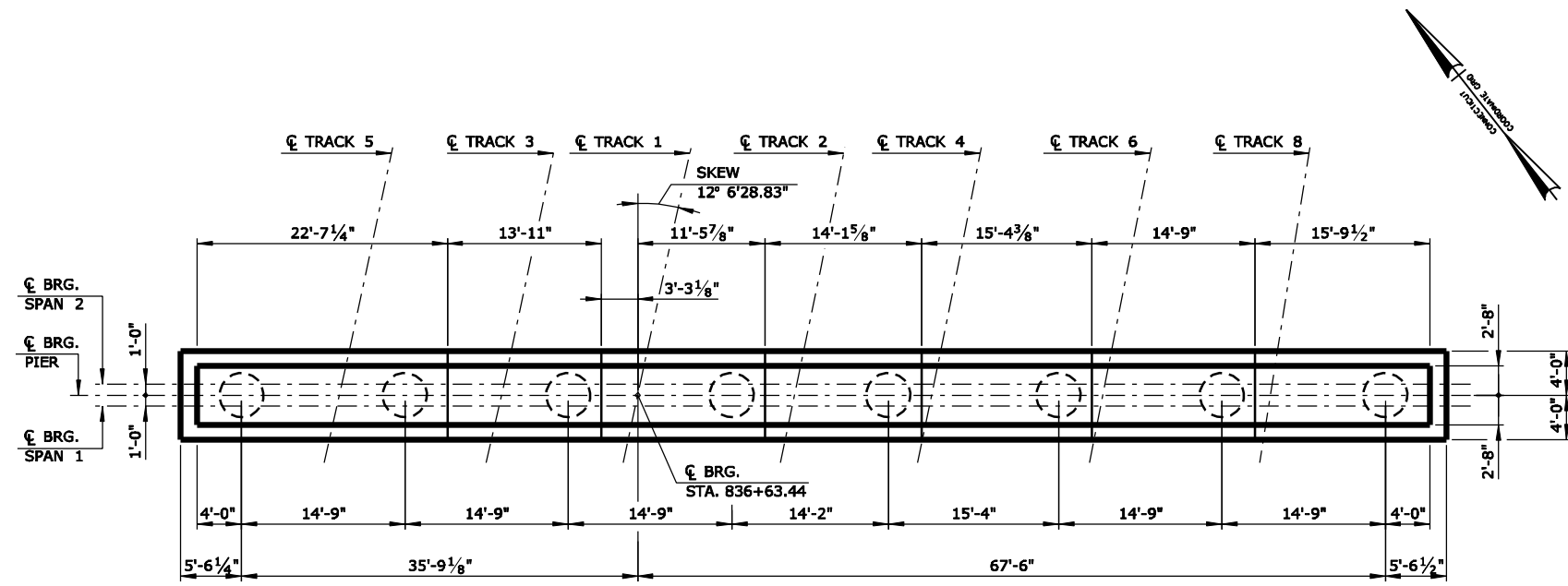

**SOUTH STAMFORD ACCESSIBILITY
& MNRR BRIDGE REPLACEMENT
FEASIBILITY STUDY**

**ELM STREET
PIER PLAN**

PIER PLAN

MAINTENANCE AND PROTECTION OF TRAFFIC

- MAINTAIN ONE LANE OF TRAFFIC DURING CONSTRUCTION OF ABUTMENTS AND PIERS.
- MAINTAIN PEDESTRIAN ACCESS ON SIDEWALK ALONG WEST ABUTMENT AND CLOSE SIDEWALK ALONG EAST ABUTMENT TO PEDESTRIAN TRAFFIC.
- CLOSE ROADWAY TO TRAFFIC TO INSTALL GIRDERS DURING WEEKEND PERIODS.

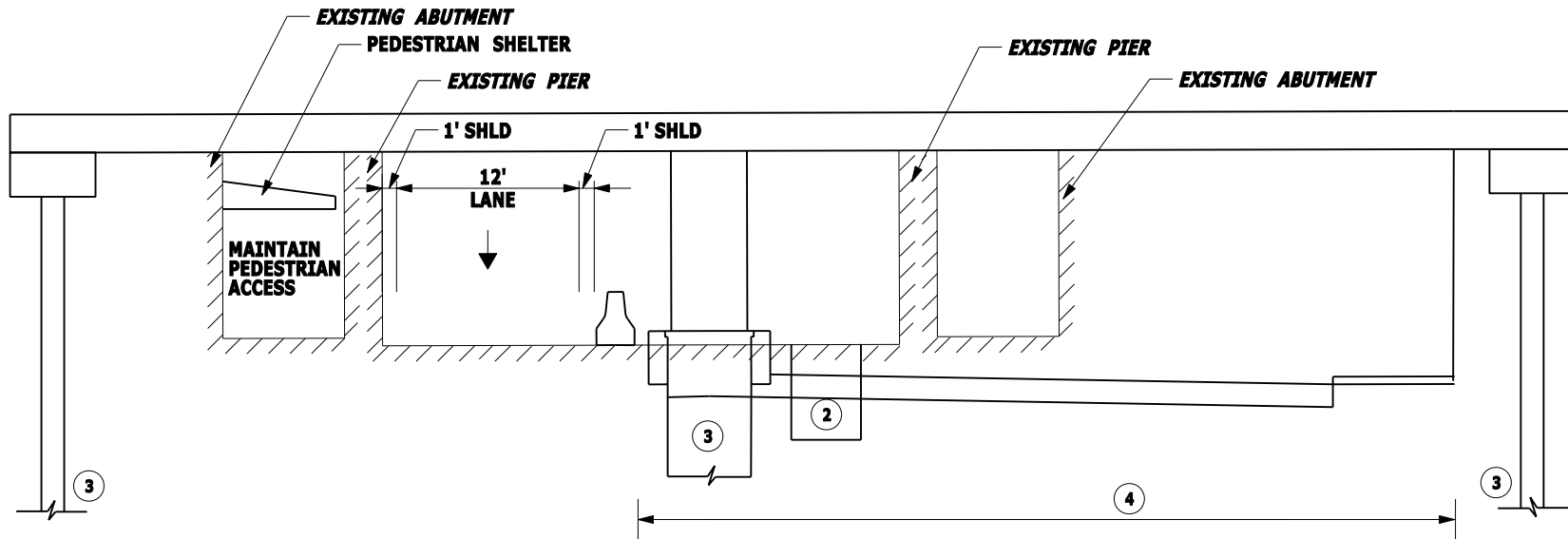

ELM STREET LOOKING NORTHBOUND

CONSTRUCTION STAGING

1. INSTALL PEDESTRIAN SHELTER.
2. RELOCATE UTILITIES AS REQUIRED.
3. CONSTRUCT ABUTMENTS AND PIERS.
4. DEMOLISH EXISTING EAST ABUTMENT AND RECONSTRUCT ROADWAY AND SIDEWALK BETWEEN EAST ABUTMENT AND PIER.

SOUTH STAMFORD ACCESSIBILITY
& MNRR BRIDGE REPLACEMENT
FEASIBILITY STUDY

ELM STREET
ROADWAY MPT - STAGE 1

URS

SCALE: 1"=12'

FIGURE 6.1a

MAINTENANCE AND PROTECTION OF TRAFFIC

- MAINTAIN ONE LANE OF TRAFFIC IN SOUTHBOUND DIRECTION AND TWO LANES IN NORTHBOUND DIRECTION DURING CONSTRUCTION OF ROADWAY AND SIDEWALK.
- MAINTAIN PEDESTRIAN ACCESS ON RECONSTRUCTED SIDEWALK ALONG EAST ABUTMENT AND CLOSE SIDEWALK ALONG WEST ABUTMENT.

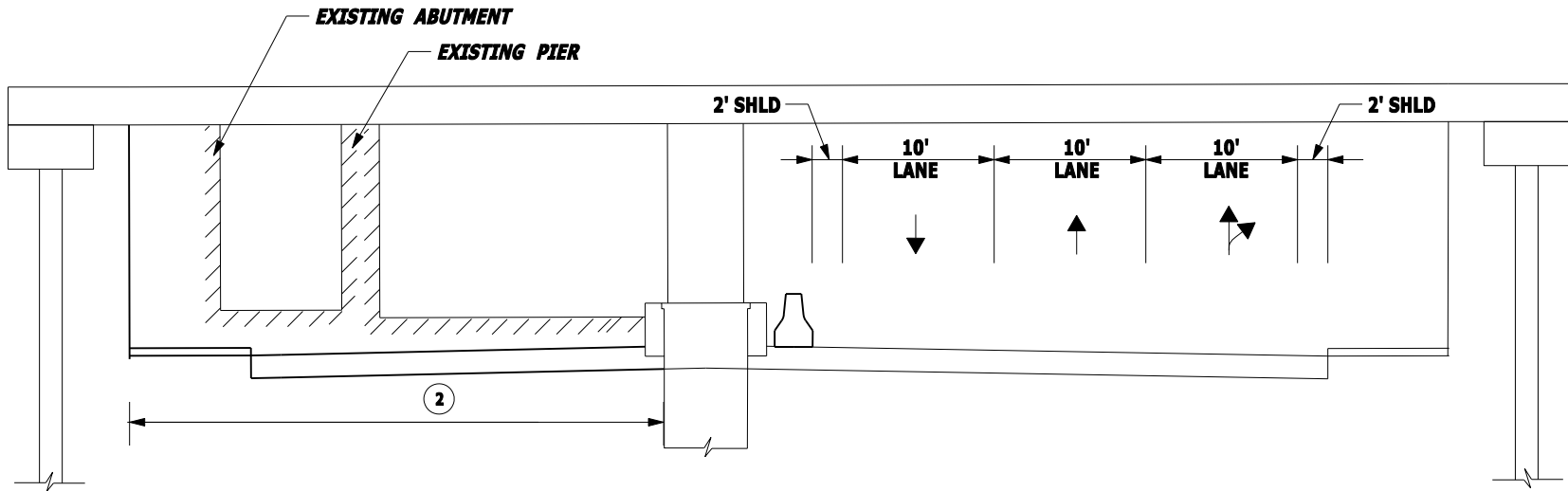

ELM STREET LOOKING NORTHBOUND

CONSTRUCTION STAGING

1. DEMOLISH EXISTING WEST ABUTMENT AND RECONSTRUCT ROADWAY AND SIDEWALK BETWEEN WEST ABUTMENT AND PIER.

SOUTH STAMFORD ACCESSIBILITY
& MNRR BRIDGE REPLACEMENT
FEASIBILITY STUDY

ELM STREET
ROADWAY MPT - STAGE 2

URS

SCALE: 1"=12'

FIGURE 6.1b

V:\135-301-Stamford_MNRB\GM2\FEASIBILITY STUDY FINAL SUBMISSION\elm_street_drainage_FS_101810.dgn
10/18/2010

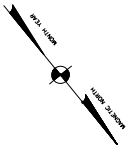
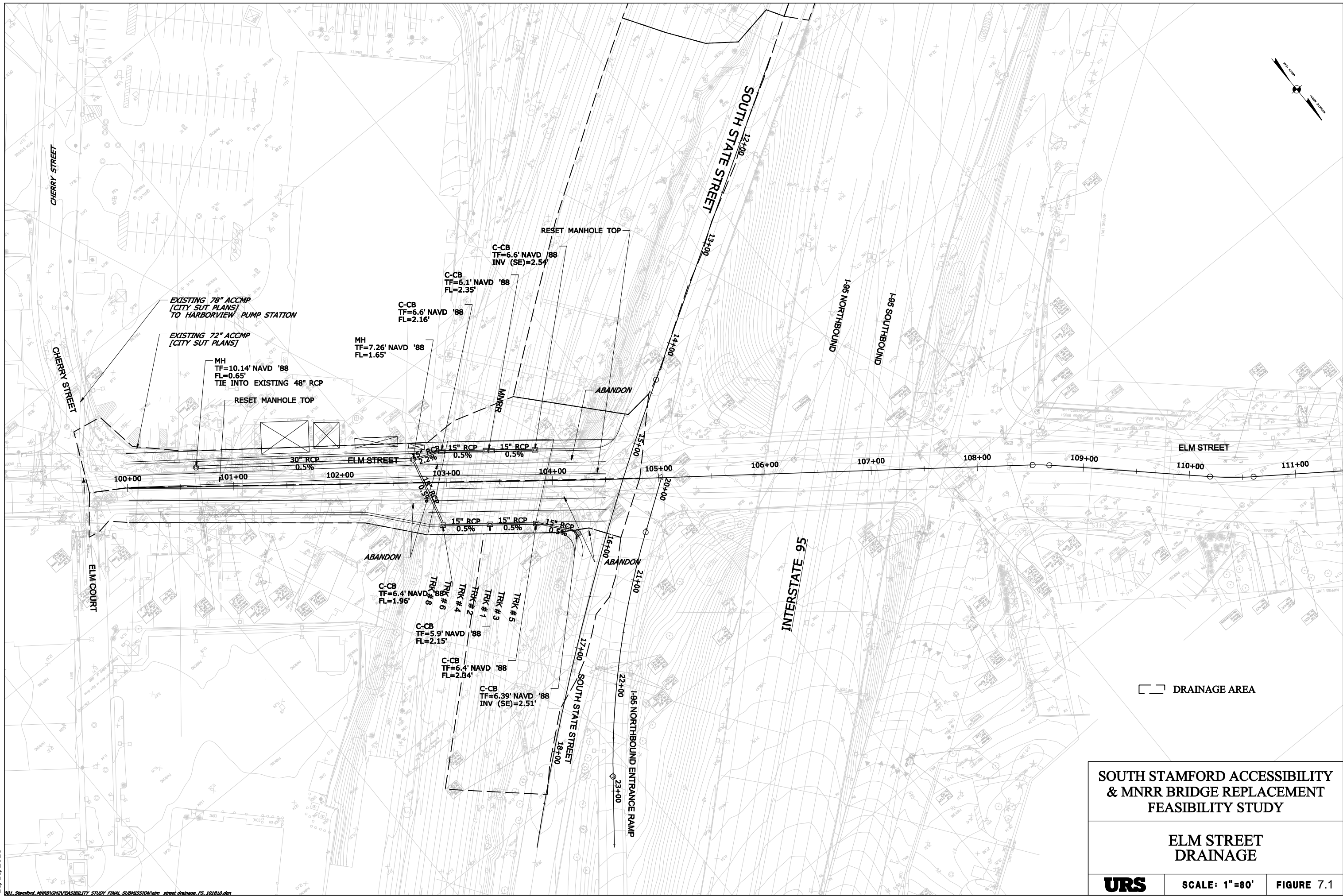

DRAINAGE AREA

| | | |
|--|---------------|------------|
| SOUTH STAMFORD ACCESSIBILITY & MNR BRIDGE REPLACEMENT FEASIBILITY STUDY | | |
| ELM STREET DRAINAGE | | |
| URS | SCALE: 1"=80' | FIGURE 7.1 |

V:\135-301-Stamford_MNRB\GM2\FEASIBILITY STUDY FINAL SUBMISSION\elm_street_drainage_FS_101810.dgn



UTILITY IMPACT

- ELECTRIC:**
 - MH - 0
 - DUCT - 0'
- TELEPHONE:**
 - MH - 2
 - DUCT - 1140'
- GAS - 520'**
- WATER - 475'**
- UTILITY POLES - 4**
- LIGHT POLES - 1**
- CITY ITS - OVERHEAD WIRE ATTACHED TO BRIDGE**

LEGEND

- GAS LINE
- TELEPHONE LINE
- WATER MAIN
- ELECTRIC UTILITY LINE

SOUTH STAMFORD ACCESSIBILITY & MNRR BRIDGE REPLACEMENT FEASIBILITY STUDY

ELM STREET UTILITY PLAN

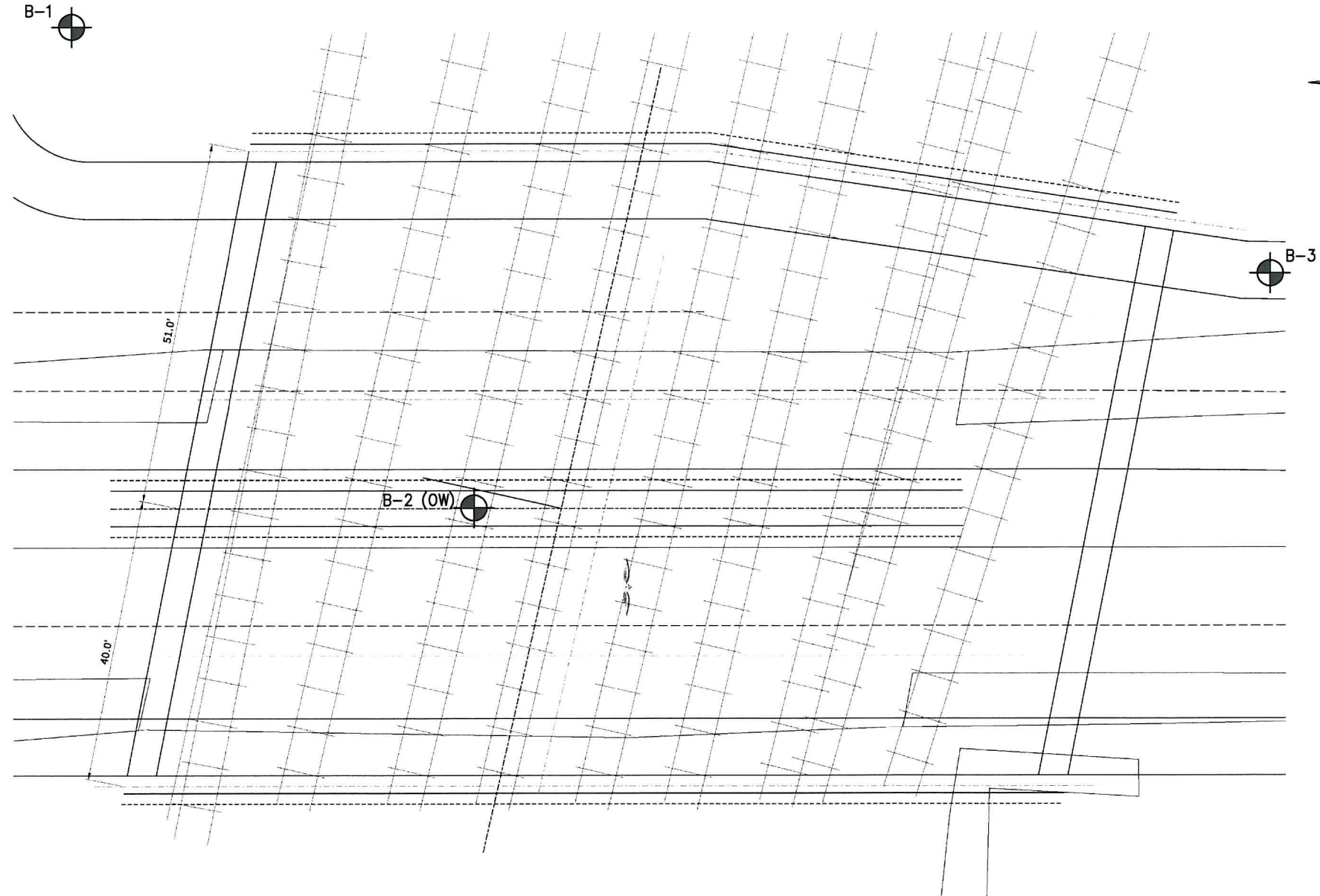

ELM STREET PLAN

LEGEND

B-1  PROPOSED PILOT BORING

NOTES:
 1) BASE MAP DEVELOPED FROM AN ELECTRONIC FILE PROVIDED BY URS ENTITLED 'METRO NORTH BRIDGE REPLACEMENT FEASIBILITY STUDY - ELM STREET PLAN' DATED 1/11/2010. ORIGINAL SCALE 1/8" = 1'-0".
 2) THE LOCATIONS OF THE BORINGS WERE DETERMINED BY TAPING AND VISUAL ESTIMATES FROM EXISTING SITE FEATURES.

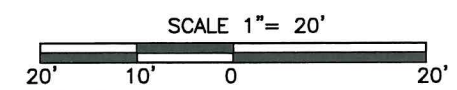

| | | |
|---|---------------|------------|
| METRO NORTH RAILROAD BRIDGE REPLACEMENT FEASIBILITY STUDY | | |
| ELM STREET PILOT BORING PROGRAM | | |
| URS | SCALE: 1"=20' | FIGURE 9.1 |

M:\CI\0101\25\PHASE 1\CADD\ELM_ST.dwg



Note: This area is shown as being protected from the 1-percent annual-chance or greater flood hazard.



MAP SCALE 1" = 500'

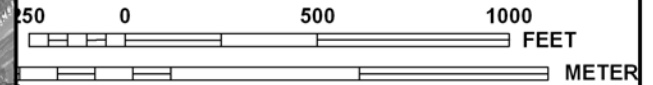

NATIONAL FLOOD INSURANCE PROGRAM

PANEL 0517F

FIRM
FLOOD INSURANCE RATE MAP

FAIRFIELD COUNTY,
CONNECTICUT
(ALL JURISDICTIONS)

PANEL 517 OF 626
(SEE MAP INDEX FOR FIRM PANEL LAYOUT)

CONTAINS:

| COMMUNITY | NUMBER | PANEL | SUFFIX |
|-------------------|--------|-------|--------|
| DARIEN, TOWN OF | 090005 | 0517 | F |
| STAMFORD, CITY OF | 090015 | 0517 | F |

Notice to User: The Map Number shown below should be used when placing map orders; the Community Number shown above should be used on insurance applications for the subject community.



MAP NUMBER
09001C0517F

EFFECTIVE DATE
JUNE 18, 2010

Federal Emergency Management Agency

METRO NORTH RAILROAD
BRIDGE REPLACEMENT
FEASIBILITY STUDY

ELM STREET
100-YEAR FEMA FLOODPLAIN

URS FIGURE 10.1

This is an official copy of a portion of the above referenced flood map. It was extracted using F-MIT On-Line. This map does not reflect changes or amendments which may have been made subsequent to the date on the title block. For the latest product information about National Flood Insurance Program flood maps check the FEMA Flood Map Store at www.msc.fema.gov