

SOUTH STAMFORD ACCESSIBILITY & MNRR BRIDGE REPLACEMENT FEASIBILITY STUDY

State Project No. 135-301
Stamford, Connecticut

PRELIMINARY ENGINEERING REPORT

Volume 2 of 7

GREENWICH AVENUE - *DRAFT*

April 01, 2011

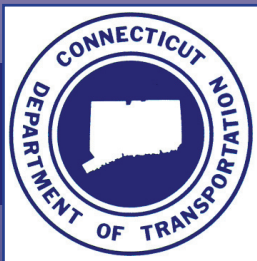

State of Connecticut
Department of Transportation

URS

500 Enterprise Dr, Ste 3B
Rocky Hill, CT 06067
Tel.: (860) 529-8882
Fax: (860) 529-3991
www.urscorp.com

TABLE OF CONTENTS – GREENWICH AVENUE

1. INTRODUCTION	1
1.1 Site Location and Description	1
1.2 Site Features	1
1.3 Proposed Improvements	2
2. HIGHWAY	3
2.1 Horizontal Alignments and Lane Arrangements	3
2.2 Vertical Profiles	4
2.3 Critical Cross-Sections	5
2.4 Rights-of-Way	5
2.5 Identification of Substandard Conditions	6
2.6 Enhancements to Pedestrian, Bus, Taxi, and Transit Operations	7
3. RAIL OPERATIONS	7
3.1 Rail Staging and Sequencing Requirements	7
3.2 Impact and Operational Issues of Proposed Construction	8
3.3 Recommendations and Conclusions	9
4. BRIDGE 03680R – MNRR OVER GREENWICH AVENUE	10
4.1 Existing Bridge	10
4.2 Proposed Improvements	10
4.2.1 Critical Controls	10
4.2.2 Superstructure Types	11
4.2.3 Abutments	13
4.2.4 Pier	13
4.2.5 Retaining Walls	14
4.3 Phased Construction Requirements	14
4.3.1 Suggested Superstructure Erection Method	14
4.4 Aesthetic Treatments	14
4.5 Summary and Conclusion	15
4.5.1 Structure Summary	15
4.5.2 Construction Duration	15
4.5.3 Estimated Construction Cost	15
5. TRAFFIC	16
5.1 Traffic Operational Requirements	16
5.2 M&PT Requirements	17
6. DRAINAGE	18
6.1 Existing System Conditions	18
6.2 System Constraints and Concepts Considered	19
6.3 Design Criteria	20
6.3.1 Gutter Flow	20
6.3.2 Pipe Flow	20

TABLE OF CONTENTS (continued)

6.3.3 Hydraulic Grade Line	21
6.4 Summary of Impacts and Proposed Improvements	21
7. UTILITIES	21
8. GEOTECHNICAL	22
8.1 Summary of Subsurface Data	22
8.1.1 Regional Geology	22
8.1.2 Pilot Borings	22
8.1.3 Subsurface Conditions	22
8.1.4 Soil	23
8.1.5 Groundwater	23
8.2 Geotechnical Construction Issues	23
8.3 Foundation Recommendations	23
9. ENVIRONMENTAL	24
9.1 Required Environmental Permits	24
10. SUMMARY AND CONCLUSION	24

APPENDIX

Appendix A – Highway Design Criteria	26
Appendix B – Bridge Design Criteria	27
Appendix C – Construction Schedule	29
Appendix D – Construction Cost Estimates	31
Appendix E – Drainage Calculations	34
Appendix F – Boring Logs	38
Appendix G – Figures	42

LIST OF FIGURES

Highway

Figure 2.1 – Project Area	
Figure 2.2 – Roadway Plan	
Figure 2.2a – Parking Lot Layout	
Figure 2.3a – Greenwich Ave, Vertical Profile	
Figure 2.3b – First Stamford Place, Vertical Profile	
Figure 2.3c – McCullough Street, Vertical Profile	
Figure 2.4a – Critical Cross Sections, Greenwich Avenue	
Figure 2.4b – Critical Cross Sections, Greenwich Avenue and First Stamford Place	
Figure 2.5 – Greenwich Avenue Typical Section	

LIST OF FIGURES *(continued)*

Rail Operations

Figure 3.1a-d – Rail Staging and Sequencing Plans for Bridge 03680R

Bridge 03680R

Figure 4.1 – Proposed Plan & Elevation
Figure 4.2 – Typical Sections, Alternate 1
Figure 4.3 – Typical Sections, Alternate 2
Figure 4.4 – Construction Staging Sections
Figure 4.5 – Construction Staging Plans
Figure 4.6 – Abutments
Figure 4.7 – Piers

Traffic

Figure 5.1 – Preliminary Traffic Signal Plans
Figure 5.2a-d – Maintenance and Protection of Traffic Staging

Drainage

Figure 6.1 – Drainage Plan

Utilities

Figure 7.1 – Utility Plan

Geotechnical

Figure 8.1 – Boring Plan

Environmental

Figure 9.1 – 100 Year FEMA Floodplain

1. INTRODUCTION

1.1 Site Location and Description

The Metro-North Railroad (MNRR) undergrade bridge¹, No. 03680R, is located 1000 feet west of the Stamford Intermodal Transportation Center (SITC). It carries four MNRR mainline tracks over Greenwich Avenue. Immediately to the north of the bridge, First Stamford Place and the Interstate 95 (I-95) northbound exit ramp intersect Greenwich Avenue at state assigned intersection number 135-278. I-95 is located approximately 150 feet north of the undergrade bridge. To the south, Greenwich Avenue intersects with Pulaski Street and Davenport Street at a triangular intersection. Please refer to Figure 2.1 for the project area, located in Appendix G.

Greenwich Avenue is classified as a Minor Arterial Roadway located on the western side of Stamford and provides a primary north / south route between Main Street and I-95 to the north and commercial and residential developments to the south. The existing MNRR bridge restricts access due to the narrow roadway width (26 feet) and substandard vertical clearance (13'-7").

Immediately south of the MNRR undergrade bridge, development consists of a commercial business on the west side of Greenwich Avenue and a housing complex owned by the City of Stamford Housing Authority on the east side. Immediately north of the bridge, park areas are located on the east side. The west side consists of intersecting roadways.

1.2 Site Features

The underpass at Greenwich Avenue is currently an undivided road with one lane in the southbound direction and one lane in the northbound direction. There are sidewalks (approximately 5 feet) on both sides of the roadway. There are no shoulders, resulting in a curb-to-curb width of 26 feet.

Immediately to the north, Stamford Place approaches Greenwich Avenue from the west with a steep downgrade of 7%. Virtually no landing area is provided before intersecting with Greenwich Avenue at a signalized intersection. First Stamford Place has a four-lane section (two lanes inbound and two lanes outbound).

Approximately 130 feet north of the MNRR undergrade bridge, the I-95 northbound exit ramp and McCullough Street intersect with Greenwich Avenue forming a four-way signalized intersection; both are one-directional in the eastbound direction. Greenwich Avenue widens to four lanes at the I-95 exit ramp and McCullough Street intersection (two lanes northbound and two lanes southbound). The I-95 exit ramp has a downgrade of approximately 6% as it approaches Greenwich Avenue. The existing landing area at

¹ An "Undergrade Bridge," in rail terms, refers to a road going under the grade of the railroad or under the track. In this case, the bridge acts to carry the tracks over Greenwich Avenue resulting in an undergrade bridge.

the end of the ramp (approximately 80 feet), provides room to accommodate any proposed lowering of Greenwich Avenue. McCullough Street has a flat downgrade away from Greenwich Avenue of approximately 0.4%. The existing triple arch bridge, which carries McCullough Street over the Mill (Rippowam) River is located only 50 feet from the existing Greenwich Avenue edge of road. Any lowering of Greenwich Avenue would impact the existing McCullough Street profile and would also require lowering of the bridge grade over the arch on the western half of the bridge.

The I-95 overpass structure has a horizontal opening of 70 feet (abutment to pier). Greenwich Avenue under the I-95 overpass consists of two through lanes and an exclusive left turn lane in the southbound direction, one lane in the northbound direction, and sidewalks on both sides. North of I-95, Greenwich Avenue tapers to a two lane section, one lane northbound and southbound, with parking on both sides of the roadway. Due to the close intersections, the area north of the bridge exhibits heavy traffic and delay on a regular basis.

South of the underpass, approximately 400 feet, Greenwich Avenue carries one travel lane in each direction and intersects with Pulaski and Davenport Streets. The intersection has a triangular geometric alignment, currently controlled by flashing red signals in all three directions. The flashing signals are required due to the poor operation of the intersection. Long range plans for this intersection include a roundabout to improve traffic operations and corridor improvements to Greenwich Avenue.

The existing Greenwich Avenue alignment within the limits of the work begins approximately 400 feet south of the MNRR bridge at the Pulaski Street, Davenport Street and Greenwich Avenue intersection. Continuing north, the alignment is tangent to the MNRR bridge. The alignment then incorporates a horizontal curve left with a radius of approximately 1,000 feet; this curve left begins in the vicinity of the First Stamford Place intersection and continues through the I-95 overpass structure. The approximate limit of work extends to approximately 300 feet north of the MNRR bridge.

The existing Greenwich Avenue vertical alignment increases in grade in a direction from the south, at the Pulaski Street intersection, to the northern project limit, at the I-95 overpass, by approximately 24 feet. From Pulaski Street, the gradient increases by approximately +4% ±, dropping to +0.5% ± under the existing MNRR bridge, then increasing to +6.0% ± at a crest vertical curve with a -3% ± tailing downgrade grade at the I-95 structure. The existing roadway elevation at the bridge is approximately 19.0 feet, which provides a substandard vertical clearance of 13'-7".

1.3 Proposed Improvements

The widening of Greenwich Avenue will expand the existing two-lane section under the bridge to a five-lane section, providing three lanes northbound and two lanes

southbound. These lanes will assist in providing the additional capacity needed to move vehicles north and south of the tracks. Additional improvements include two-foot shoulders, five-foot bike lanes, and a median to divide opposing traffic. The proposed bike lanes would provide a southerly link for the Master Plan development of the Mill River Park and Greenway System. With this project, the southbound bike lane begins at the First Stamford Place driveway. The northbound bike lane terminates 100 feet before the right-turn only lane onto McCullough Street begins. The Mill River Park and Greenway System Master Plan extends the system to the river trail through connections at Selleck Street, the park at the corner of McCullough Street and Greenwich Avenue, and points to the north from Greenwich Avenue. Eventually this connects into the existing Mill River Park and Greenway System recently completed north of West Main Street.

The reconstruction of the MNRR undergrade bridge will also provide a vertical clearance of 14'-6" to permit the passing of all legal height vehicles. The largest vehicles owned and operated by the City of Stamford are a HazMat truck and the Police Department's command vehicle, both of which have a height of 12'-6".

The proposed work on the undergrade bridge includes total replacement of the superstructure and substructure, with the exception of a portion of the west abutment which is expected to remain. The deck type proposed for the bridge is the MNRR preferred ballasted deck rather than the open deck type currently in place. The reconstruction will provide a new bridge and improve the movement of traffic.

2. HIGHWAY DESIGN

2.1 Horizontal Alignments and Lane Arrangement

The proposed lane arrangements for Greenwich Avenue are based on discussion with the Connecticut Department of Transportation (CTDOT) and the City of Stamford. Please see the attached proposed typical cross section, Figure 2.5, located in Appendix G. The proposed lane arrangements include:

- two 11-foot lanes in the southbound direction
- three 11-foot lanes in the northbound direction
- 5-foot bike lanes southbound
- 5-foot shoulder northbound (potential future bike lane)
- 8-foot median
- 2-foot shoulders between the inside lanes and the median
- 5'-10" sidewalks

The Greenwich Avenue curb-to-curb width will total 77'-0" at the undergrade bridge. To provide for the proposed cross section, a widening of the roadway to the east is proposed. A widening to the east is preferred in order to minimize the steep grade impacts of the First Stamford Place driveway from the lowering of Greenwich Avenue, to avoid conflicts with the existing catenary tower located on the west side of the

MNRR bridge, and to minimize the impact to commercial property located south of the bridge and west of Greenwich Avenue. However, an easterly widening would impact the existing housing complex south of the MNRR bridge and east of Greenwich Avenue. The existing parking lot of the complex would need to be reconfigured to provide an equal number of spaces lost with the proposed roadway alignment (please refer to Figure 2.2a, located in Appendix G).

The proposed horizontal alignment for the Greenwich Avenue undergrade bridge is a series of horizontal curves with radii of 382 feet, 410 feet and 382 feet running from south to north. From the south, at the intersection of Pulaski Street and the north end of the triangle, the first 50 foot taper provides a two lane section for the east and west legs of the triangle. The second 50 foot taper just south of the MNRR undergrade bridge, provides the three-lane section under the bridge; two through lanes and a right-turn only lane onto McCullough Street. North of McCullough Street the two through lane section tapers to one lane to match the existing condition. The designated bike lane would end 100 feet in advance of the turn lane in accordance with MUTCD. A five foot wide shoulder would be provided in this area.

The proposed horizontal alignment traveling southbound is tangent except for two short horizontal curves, an 800-foot radius curve to match the existing alignment at the south end and a 400-foot radius curve in the vicinity of the I-95 exit ramp. Three lanes, two through lanes and a left-turn only lane onto McCullough Street, are proposed at the I-95 exit ramp and McCullough Street intersection to match the existing condition. South of the intersection, two through lanes are proposed at the triangle intersection with Pulaski Street where the two lanes split for the east and west legs of the triangle.

The existing lane arrangements are proposed to remain for the First Stamford Place driveway (two lanes inbound and two lanes outbound), I-95 exit ramp (two through lanes, right-turn lane and left turn lane – one way eastbound) and McCullough Street (two through lanes - one way eastbound).

2.2 Vertical Profiles

Please see the attached Profile Plans (Figure 2.3a, 2.3b, 2.3c – located in Appendix G) for Greenwich Avenue, the First Stamford Place driveway, the I-95 exit ramp and McCullough Street.

To provide the desired vertical clearance of 14'-6", the existing profile will need to be lowered approximately 4.2 feet. This is due to the increased depth of structure (5.5 feet measured from top of track to bottom of girder) and an additional 11 inches of vertical clearance. To accomplish this change, an undulating profile is proposed.

Beginning at the Pulaski Street intersection, a 180-foot long crest curve begins with a proposed grade of 3.87%, and ends with a downgrade of 1.8%. This curve provides a design speed of 35 miles per hour (mph). At the MNRR undergrade bridge, an 85-foot long sag vertical curve is proposed with downgrade of 1.8% and upgrade of 8.0%. This

curve provides a 20 mph design speed based on comfort criteria. At the north end, a 180-foot crest curve is proposed with an upgrade of 8% and downgrade of 3% to match the existing at the I-95 structure. This curve provides a 25 mph design speed. Critical control points at the bridge are the southwest corner at Station 3+57.76, 22 feet left and the northeast corner at Station 4+78.84, 44.75 feet right. A maximum roadway elevation based on the existing track elevation is 15.83 feet to provide the 14'-6" minimum vertical clearance.

Because Station 4+78.84 is also opposite the First Stamford Place driveway, the Greenwich Avenue profile also governs the grade required at the intersection with the First Stamford Place driveway, which requires a lowering of 4.2 feet. To accommodate this lowering, the proposed First Stamford Place driveway profile incorporates a 10% grade with a 60-foot landing area. The western limit and proposed match point is controlled by the existing entrance drive to the under building parking garage and gate at the top of the hill (Station 600+50). Based on the proposed lowering, 460± feet of the roadway will need to be reconstructed.

At the I-95 exit ramp and McCullough Street, the grade at each intersection would require a lowering of approximately 1.8 feet and 1.9 feet respectively based on the proposed Greenwich Avenue grade. This requires 115± feet of the ramp to be reconstructed and 120 feet of McCullough Street. The McCullough Street work would also require reconstruction of the pavement structure over the existing bridge to accommodate the grade change. This bridge is a triple arch structure and it appears there is ample cover over the arch to accommodate the grade change of approximately 1.5 feet at the west end.

2.3 Critical Cross Sections

Figures 2.4a and 2.4b, located in Appendix G, show the critical cross sections taken at Station 1+00, 2+75 and 5+40 on Greenwich Avenue and at Station 504+00 on the First Stamford Place driveway, which also extends north to the I-95 exit ramp. These cross sections show the grading that is required to match the proposed design into the existing conditions. Station 5+40 on Greenwich Avenue and the First Stamford Place driveway Station 504+00 have the greatest cut due to the required lowering of approximately 3 feet to accommodate the new bridge and vertical clearance of 14'-6".

2.4 Rights-of-Way

Property acquisition and easements will be needed based on the proposed plan. These are listed as follows:

- Commercial property (N/F Susie Larusso, Et al.) south of the MNRR bridge and west of Greenwich Avenue
 - Property acquisition – 1,200± SF
 - Slope easement - 1,200± SF

- Vacant property (N/F Greenwich Ave. LLC) south of the MNRR bridge and west of Greenwich Avenue
 - Property acquisition – 1,200± SF
 - Slope easement - 1,200± SF
- Housing Complex (N/F Housing Authority of Stamford) south of the MNRR bridge and east of Greenwich Avenue
 - Property acquisition – 6,700± SF
 - Slope easement and parking lot reconstruction – 10,000± SF
- Metro-North RR property NE, NW, SE, and SW corners
 - East side of Greenwich Avenue
 - Property acquisition – 6,400± SF
 - West side of Greenwich Avenue
 - Slope Easement – 1,000± SF
- Park property (First Stamford Place, LLC.) north of the MNRR bridge and east of Greenwich Avenue
 - Property acquisition – 1,680± SF
 - Slope easements - 700± SF
- First Stamford Place (First Stamford Place, LLC.) north of the MNRR bridge and west of Greenwich Avenue
 - Slope easements- 20,000± SF (includes roadway)

2.5 Exceptions to Geometric Design Criteria

The sag curve under the MNRR undergrade bridge provides a 20 mph design speed based on comfort design criteria; comfort design criteria means visibility is provided by street lights and not dependent on vehicle headlights. Because the 20 mph design does not meet the recommended 30 mph design speed as noted in Appendix A, a design exception will be required.

The recommended clear zone is 14 feet. A 10-foot clear zone is proposed for the proposed bridge abutments requiring a design exception.

The crest curve at the north project limit provides a 188-foot stopping sight distance. This does not meet the criteria for a recommended design speed of 30 mph; therefore, a design exception will be required.

Please refer to Appendix A for a summary of all recommended and proposed design values.

2.6 Enhancements to Pedestrian, Bus, Taxi, and Transit Operations

The project provides pedestrian and bike enhancements within the project area that will also provide links to other long-range improvements planned by the City.

- 5-foot bike lanes are proposed on both sides of the roadway
- Sidewalks are proposed on both sides of the roadway

To the south of this project, the City’s plan is to improve the Greenwich Avenue corridor from the Pulaski Street intersection south to Selleck Street. This plan will provide streetscape improvements including improved bike and pedestrian access as well as overlooks to the Mill River. This project will provide a link to that system.

To the north, ongoing projects have included the Mill River Pedestrian and Bicycle Trail running from the Greenwich Avenue and Main Street intersection (approximately 1,200 feet north of this project limit). This project would provide an additional link to complete the entire Mill River Master Plan.

3. RAIL OPERATIONS

3.1 Rail Staging and Sequencing Requirements

The Greenwich Avenue bridge is an undergrade structure on the New Haven Line at mile post (MP) 32.81 in Stamford. The bridge is situated between CP232 (SELLECK) and CP233. CP232 and CP233 are interlockings². The “CP” signifies Control Point, the “2” indicates that the interlockings are located on the New Haven Line, and the last two digits indicate approximate mile posts.

Greenwich Avenue bridge is located approximately 1,000 feet west of the SITC. The bridge carries four tracks: the four New Haven Line mainline tracks, numbered 3, 1, 2, and 4. Replacement of the bridge will be done one track at a time. The replacement work will require that each track be taken out of service while the reconstruction work on the portion of the bridge under that track is performed. The bridge replacement work can be done either working in the north to south, or the south to north direction.

The Construction Staging Plans for the Greenwich Avenue bridge (please refer to Appendix C for the Construction Schedule) show the reconstruction of the bridge being progressed in a north to south direction (Track 3 to Track 4). The bridge reconstruction work is shown being done in four main stages. Each of these stages will require a continuous track outage for the track being replaced on the portion of the bridge being reconstructed. The duration of the continuous track outages required for each track reconstruction is estimated to be 150 calendar days.

² Interlockings are switches and/or crossovers that allow trains to travel from one track to another governed by signal indications. On the New Haven line, these points are remotely controlled by the MNRR Operations Control Center.

The continuous track outages will impact the use of the SITC passenger platforms. During these outages, the normal routing of trains into the station area will have to be adjusted to accommodate the out of service tracks and passenger platforms.

With the mobilization period, the 150 calendar days required for each continuous track outage, and the approximate 5 month period to complete the roadway work under the bridge, the total project duration time for the replacement of the Greenwich Avenue bridge is approximated at 2 years, 6 months.

3.2 Impact and Operational Issues of Proposed Construction

The SITC has two center (island) passenger platforms. This allows for five tracks to maintain train operations through the SITC. This includes four tracks for passenger boarding/disembarking and one through track. The additional operating track in the station is designated as Track 5. The five operating tracks in the station area converge back to the four operating New Haven Line mainline tracks at the west end of the station. Track 5 in the station primarily serves the New Canaan Branch, but it is also used by several other scheduled Metro-North New Haven Line commuter trains.

Replacement of Track 3 - When Track 3 at the Greenwich Avenue bridge is taken out of service, passenger platform Track 5 in the SITC will also be out of service for eastbound and westbound trains. Please refer to Figure 3.1a, located in Appendix G.

Eastbound trains on Track 3 will use SELLECK (CP232) to divert to one of the other three adjacent in-service passenger platform tracks or to Track 1, in the station area.

Westbound trains on Track 5 will be required to use CP234 to divert to one of the other three adjacent in-service passenger platform tracks or to Track 1, in the station area.

Replacement of Track 1 - When Track 1 at the Greenwich Avenue bridge is taken out of service, platform Track 3 and through Track 1 in the station area will be out of service for eastbound and westbound trains. Please refer to Figure 3.1b located in Appendix G.

Eastbound trains on Track 1 will use SELLECK to divert to one of the other three adjacent in-service passenger platform tracks.

Westbound trains on Tracks 3 and 1 will be required to use CP234 to divert to one of the other three adjacent in-service passenger platform tracks in the station area.

Replacement of Track 2 - When Track 2 at the Greenwich Avenue bridge is taken out of service, platform Track 2 in the station area will be out of service for eastbound and westbound trains. Please refer to Figure 3.1c, located in Appendix G.

Eastbound trains on Track 2 will use SELLECK to divert to one of the other three adjacent in-service passenger platform tracks or to Track 1.

Westbound trains on Track 2 will be required to use CP234 to divert to one of the other three adjacent in-service passenger platform tracks or to track 1, in the station area.

During the Track 2 outage at the Greenwich Avenue bridge, a consideration may be given to installing bridge plates or a temporary platform from the south center platform over Track 2. The temporary platform would allow Track 1 (normally a through track) to be used as a passenger boarding and disembarking track.

Replacement of Track 4 - The Track 4 outage at the Greenwich Avenue bridge will not require any of the four passenger platform tracks or through Track 1 in the SITC to be taken out of service. Please refer to Figure 3.1d, located in Appendix G.

Eastbound trains on Track 4 will use SELLECK to divert to one of the adjacent in-service tracks around the track 4 bridge construction work. Eastbound trains will also be able to use the 2-4 crossover in CP233 to access the Track 4 passenger platform in the station area.

Westbound trains will be able to use all four of the passenger platform tracks and through track 1 in the station area. Westbound trains on Track 4 will be able to use the 2-4 crossover in CP233, west of the station, to run around the Track 4 outage at the Greenwich Avenue bridge.

3.3 Summary and Conclusions

Construction of the Greenwich Avenue bridge will impact train operations both east and west of the SITC. Use of the SITC passenger platform tracks will also be impacted during the reconstruction of each track section of the bridge.

The Greenwich Avenue bridge construction will require modifications to train operations through the SITC area. The bridge work will also require several adjustments to normal train routing thru SELLECK interlocking, and both east and west of the SITC area during reconstruction of each of the tracks.

It is recommended that this bridge be considered for reconstruction in the same time frame as the Atlantic Street bridge. Construction of the Greenwich Avenue and Atlantic Street bridges will similarly impact the train operation in and through the SITC area. It would be cost effective to combine the station impacts and train operation inconveniences required for each of these bridges in a single construction sequencing period, rather than having to allow for them twice in different construction timeframe periods.

It is not recommended that the Greenwich Avenue bridge be considered for reconstruction in the same time frame as the Canal Street bridge. This is not recommended because these bridges are within the SELLECK, CP233, and CP234 area and concurrent construction of them could cause substantial and severe restrictions on train operations in these interlockings and to the SITC passenger platform tracks.

The Greenwich Avenue bridge could also be considered for reconstruction with the Elm Street and East Main Street bridges. Metro-North should be consulted for its concurrence regarding these recommendations, and to determine any other train operation impacts.

4. BRIDGE 03680R – MNRR OVER GREENWICH AVENUE

4.1. Existing Bridge

Existing Bridge No. 03680R carries four tracks over Greenwich Avenue. Built in 1896, it is a 63-foot, open deck, three-span structure with a through-girder center span and deck girder end spans. The bridge is supported on stone masonry abutments and steel piers. The track alignment at the bridge is curved on a radius of approximately 3,000 feet and is skewed to the roadway with a skew angle of 52 degrees. The curve is to the right proceeding west to east. East of the bridge, the track alignment becomes tangent approaching the SITC. Please refer to Figure 4.1 in Appendix G for the general plan and elevation.

In a bridge inspection report dated October of 2008, the bridge was listed to be in fair condition. It has been rated for a Cooper E64 loading as its normal load rating, which is controlled by the shared through girders. While the structure is functional, the bridge is a bottleneck for traffic at Greenwich Avenue and should be replaced.

4.2. Proposed Improvements

Proposed improvements include:

1. Increasing the bridge span length to accommodate the wider curb-to-curb width of Greenwich Avenue.
2. Increasing the vertical clearance to accommodate all legal height vehicles.

4.2.1. Critical Controls

The critical controls that must be considered in the layout, design and construction of this bridge are as follows:

- The existing rail elevations and alignments are to be maintained.
- A minimum vertical clearance of 14'-6" is to be maintained under the proposed bridge. This will involve lowering the profile of Greenwich Avenue under the bridge.

- Only one track can be closed at a time to rail traffic. Therefore, construction will require four stages. Please refer to Figures 4.4 and 4.5 for construction staging, located in Appendix G.
- In order to facilitate demolition of the existing bridge, the existing alignment for the bridge will be maintained.
- The tracks are superelevated and on a horizontal curve through the entire length of the proposed bridge. Extents of demolition and construction during stage construction are determined by the needs of accommodating a curved track on a straight bridge and the limits of demolition of the existing superstructure.
- The ballasted deck configuration, preferred by Metro-North Railroad, is to be used. The following configuration has been assumed:
 - Height of Rail = 8”
 - Thickness of Tie = 8.5”
 - Minimum Thickness of Ballast under Tie = 8.5”
 - Thickness of Ballast Mat = 1”
 - Cross Slope = 1/8” per 1’-0” for drainage.
- Impacts to catenary towers should be minimized where possible to maintain railroad operations.
- Temporary lateral earth retaining system to protect and maintain live tracks will be required between stages.
- Stability of the existing substructures during staged construction will need to be investigated. Temporary earth retaining structures may be needed in front of the existing substructures during stage construction.
- Structure to be designed in accordance with AREMA specifications for Cooper E80 loading. Each stage will need to be investigated separately.

4.2.2. Superstructure Types

Several bridge types were considered for the preliminary engineering study including:

- ballasted deck half-through girders
- 2-girder ballasted concrete deck
- multi-steel girder ballasted steel plate deck
- precast multi concrete-encased beams
- prestressed butted box beams

The controlling design span length is approximately 64’-6” feet, controlled by the northbound travel lanes of Greenwich Avenue. For consistency while comparing overall depth of structure between the structure types, the superstructure depth is measured from the top of track to the bottom of the girder. This includes common

dimensions like $7\frac{5}{16}$ " rail height, $8\frac{1}{2}$ " concrete ties, $8\frac{1}{2}$ " minimum ballast thickness, and 1" ballast mat. Dimensions for specific structure types include a 13" concrete deck with haunch for the two-girder option, $1\frac{1}{2}$ " steel deck plate for the through-girder option, and 2" thick steel deck plate for the multi-steel girder option.

Half-Through Girders: This structure type allows the top of the girder to be above the deck, limited only by the railroad clearance envelope. This permits a reduction in the superstructure depth, which is measured from the top of track to the bottom of the bottom flange. However, this may not be the case for short spans where the geometric configuration of the deck framing system would require larger superstructure depths than structurally required.

Two-Girder Ballasted Concrete Deck: This superstructure type consists of two girders below a ballasted concrete deck. This is generally more economical compared to other superstructure types, as it is the simplest to fabricate and to erect. One weakness of this structure type is that all girders are fracture critical. Additionally, it usually requires the greatest superstructure depth, adding to the amount Greenwich Avenue would have to be lowered in order to attain the required minimum vertical clearance.

Multi-Steel Girder Ballasted Steel Plate Deck: This framing system requires a shallower superstructure than a two-girder framing system. However, unlike the two-girder system, the multiple steel girders offer structural redundancy and are therefore not considered to be fracture critical. It is more economical to fabricate and to erect compared to a through girder system, but requires more maintenance throughout its design life. This steel superstructure requires a higher life-cycle cost than the precast multi concrete-encased beam option. This option requires a $5\text{'-}10\frac{5}{16}$ " superstructure depth at Greenwich Avenue. This structure type would provide an out-to-out width of 62'-6".

Precast Multi Concrete-Encased Beams: This superstructure type is economical and requires low maintenance. The butted beam construction allows for a ballasted track without the need to provide for an additional deck system. This structure type offers the shallowest superstructure depth among the alternatives considered, but usually requires significantly more steel than the other alternatives. This system is appropriate for short to moderate span lengths. This option would require a $5\text{'-}1\frac{5}{16}$ " superstructure depth at Greenwich Avenue. This superstructure type would provide an out-to-out width of 61'-6".

Prestressed Butted Box Beams: Butted box beams are generally economical, easy to erect, and require low maintenance. Similar to the precast multi concrete-encased beams, they allow for a ballasted deck without the need to provide for an additional deck system. However, precast butted box beams offer limited superstructure depth options, generally requiring larger superstructure depths than

the precast multi concrete-encased beams. For this reason, this option will not be considered in this study.

After consideration of the advantages and disadvantages of each superstructure type, two structure alternatives were selected for further consideration. Concrete Encased Steel Girders and Steel Plate Girders with a Steel Deck were evaluated for replacement of the MNRR undergrade bridge over Greenwich Avenue. Please refer to Figures 4.2 and 4.3 for the typical sections of a concrete encased steel girder bridge and for the multi-steel plate girder bridge, located in Appendix G.

4.2.3. Abutments

The abutments for both the superstructure alternatives are of a similar type.

The west abutment will be a reinforced concrete stub abutment on drilled mini-piles. A portion of the top of the existing west abutment will be demolished and a new stub abutment will be constructed on top of the existing abutment. Since the loads from the proposed superstructure will be higher than what the existing brownstone abutment can support, the stub abutment will be independently supported on drilled mini-piles that are socketed in rock. The mini-piles will bypass the existing abutment and transfer loads directly into rock. This abutment will have to be constructed in stages.

The east abutment will be a conventional cantilevered full-height reinforced concrete abutment founded on (assumed) spread footings and will have to be constructed in stages. Please refer to Figure 4.6 located in Appendix G for details pertaining to the abutments.

Due to the lowering of the profile of Greenwich Avenue, permanent earth retaining systems may be needed in front of the existing west abutment to support the existing brownstone abutment that is being retained. This will have to be evaluated further once more geotechnical information becomes available.

4.2.4. Pier

The pier for both the superstructure alternatives is similar.

The pier will be a multi-column reinforced concrete pier supported on a drilled shaft foundation. The pier will be located in the same location as the existing east pier (in between the proposed southbound and northbound lanes of Greenwich Avenue). The pier will have to be constructed in stages. Please refer to Figure 4.7 located in Appendix G for details pertaining to the pier.

Founding the pier on a spread footing or a conventional pile supported footing is not an option if it is desired to maintain two lanes of traffic on Greenwich Avenue at all times during construction.

4.2.5. Retaining Walls

All four retaining walls for the proposed bridge will be conventional reinforced concrete cantilevered retaining walls supported on a spread footing.

4.3. Phased Construction Requirements

Prior to the construction of the bridge, the existing profile of Greenwich Avenue will have to be lowered in order to satisfy the vertical clearance requirements. This needs to be done since the proposed superstructure is deeper than the existing superstructure.

Subsequent to the lowering of the profile, the proposed bridge will be constructed in four stages from north to south as shown in the stage construction plan and stage construction sections. It is anticipated that each stage will take one construction season to complete.

4.3.1. Suggested Superstructure Erection Method

The present conditions around the track make for a challenging erection procedure. Particular challenges include:

- obtaining the required vertical clearance
- horizontal clearances limited by adjacent live tracks
- maintenance of traffic
- overhead wires

A method of construction erection that is suited to these constraints is to launch the girders on the out-of-service track. This involves the building of a beam erection frame on both the abutment and the pier at track level. These frames will support an erection beam that will span from pier to abutment and be capable of supporting at least one half the weight of a bridge beam. The bridge beam will be delivered to the site via rail car on the track that is out of service. One end of the bridge beam will be supported by rollers on the bottom flange of the erection beam while the other end of the beam will be supported on land by another rolling mechanism. The bridge beam will be launched across the span and lowered to its permanent location. These steps will be repeated for all beams to complete the superstructure.

4.4. Aesthetic Treatments

The existing Bridge No. 03680R is currently supported on brownstone abutments. At the west abutment, a portion of the existing abutment is being retained with a pile supported concrete stub abutment on top of it. Architectural formliner will be used on all new cast-in-place concrete walls and the east abutment to mimic the aesthetic effect of the existing brownstone abutments.

4.5. Summary and Conclusion

4.5.1. Structure Summary

It is proposed that the existing three-span plate girder bridge be replaced as a two-span structure with one of the two proposed bridge types. A longer proposed span to accommodate additional travel lanes for the underpass will require the addition of a pier in order to minimize structure depth.

Five structure types were considered for feasibility. Non-viable options were eliminated and the remaining options were considered for their impacts to the Greenwich Avenue profile, constructability and cost.

One track will be taken out of service at a time to mitigate impact to rail operations. As a result, construction will progress in phases. Each phase will require a track outage where the existing bridge will be removed and reconstructed without disturbing the adjacent tracks which are to remain in operation. Given the conditions for constructing the proposed abutments, the west abutment will be constructed in a top-down fashion. For the purposes of this report, the tracks were replaced from north to south.

4.5.2. Construction Duration

Due to the limitations in working around Metro-North schedules and track shutdowns, each stage of construction will likely take one construction season to complete. The work involved in lowering the profile on Greenwich Avenue can be done concurrently with the stage construction of the bridge. It is anticipated that the replacement of the whole bridge will take 2 years and 6 months to complete.

4.5.3. Estimated Construction Cost

Construction cost estimates have been developed based on the weighted unit prices listed in the Connecticut Department of Transportation's Item Master File (December 2010) and the CTDOT's Preliminary Cost Estimating Guidelines (January 2011). The cost estimates do not include costs associated with environmental studies, environmental remediation, rights-of-way acquisitions, or professional services for survey, design, or construction engineering & inspection. The construction costs for the Elm Street site are summarized as follows:

Alternative 1: Concrete Encased Steel Beams

Roadway, Drainage, Traffic and Structures	\$	17,393,000
Utilities	\$	2,191,000
Railroad	\$	3,962,000

Incidentals & Contingencies	\$ 5,740,000
Totals	\$ 29,286,000

Alternative 2: Multi Steel Girders

Roadway, Drainage, Traffic and Structures	\$ 17,982,000
Utilities	\$ 2,191,000
Railroad	\$ 4,131,000
Incidentals & Contingencies	\$ 5,934,000
Totals	\$ 30,238,000

These costs include railroad operations and force account costs, but are exclusive of utility relocation, right-of-way acquisition, temporary easement applications, wetland mitigation, site remediation, engineering, and construction administration costs. Please refer to Appendix D for more details pertaining to the cost estimate.

5. TRAFFIC

5.1 Traffic Operational Requirements

Greenwich Avenue is a multi-lane roadway that is classified as a Minor Arterial Roadway. It is located on the western side of Stamford and provides a primary north-south route between Main Street and I-95 to the north, and commercial and residential developments to the south. The existing MNRR undergrade bridge restricts access due to the narrow roadway width (26 feet) and substandard vertical clearance (13'-7"). At the crossing, Greenwich Avenue provides only one lane of traffic in each direction.

The existing Greenwich Avenue alignment within the limits of the work begins approximately 400 feet south of the MNRR bridge at the Pulaski Street, Davenport Street and Greenwich Avenue intersection. Continuing north, the alignment is on a tangent to the MNRR bridge. The alignment then incorporates a horizontal curve left with a radius of approximately 1,000 feet beginning in the vicinity of the First Stamford Place driveway intersection and continuing through the I-95 overpass structure.

Immediately north of the undergrade bridge, the First Stamford Place driveway intersects Greenwich Avenue from the west, providing two travel lanes in each direction. The I-95 exit ramp and McCullough Street/South State Street intersect Greenwich Avenue approximately 130 feet north of the bridge. The I-95 exit ramp and McCullough Street are both one-way in the eastbound direction, with the ramp carrying four approaching lanes, and McCullough Street carrying two departing lanes. Due to the close intersection spacing, the area north of the bridge exhibits heavy traffic and

delay on a regular basis. However, the closely spaced intersections and the undulating vertical alignment also has a calming effect on traffic.

South of the MNRR, Greenwich Avenue consists of a single lane in each direction, and intersects Pulaski and Davenport Streets approximately 400 feet to the south with a triangular geometric alignment. This intersection is currently controlled by a flashing red signal in all directions due to the poor operation of the intersection. Long range plans for this intersection include the installation of a roundabout to improve traffic operations and corridor improvements to Greenwich Avenue.

The proposed reconstruction will provide additional lanes in both the northbound and southbound directions. A second southbound through-lane is proposed along with a second northbound through-lane, and a dedicated right-turn only lane in the northbound direction onto McCullough Street/South State Street. These lanes will provide additional capacity for traffic movements in the north/south direction, west of the Mill River.

Additional through lanes on Greenwich Avenue will result in the replacement of the traffic signal equipment. A conceptual layout is included in this report. The new traffic signal will be designed in accordance with the requirements of the Manual of Uniform Traffic Control Devices (latest edition) and also incorporate Connecticut DOT and City of Stamford requirements. Horizontal traffic signals and auxiliary signal heads may be required because of sight line restrictions in the northbound direction under the proposed bridge. Since no change is anticipated in the directional flow of traffic or the number of approaches, it is proposed that the traffic signal phasing remain as it currently exists with a four phase operation. The four phase operation includes an arterial phase followed by a clearance phase, a signal phase for the I-95 exit ramp, and a signal phase for the First Stamford Place driveway. Pedestrians would be accommodated in marked crosswalks with actuated concurrent pedestrian phases with pedestrian signals. The City would continue to be able to coordinate, adjust and control the revised traffic signal through the City's operation center.

5.2. M&PT Requirements

Greenwich Avenue crossing under the MNRR undergrade bridge will be widened to accommodate three 11-foot lanes in the northbound direction (two through lanes and one right-turn only lane) and two 11-foot through lanes in the southbound direction.

The proposed horizontal alignment follows a series of horizontal curves with radii of 382 feet, 410 feet and 382 feet running from south to north. The southbound alignment is tangent with the exception of two short horizontal curves; an 800-foot radius curve to match the existing alignment at the south end and a 400-foot radius curve in the vicinity of the I-95 exit ramp.

The vertical alignment on Greenwich Avenue will consist of a sag curve to provide a minimum clearance of 14'-6" under the MNRR bridge. This will require Greenwich Avenue to be lowered by approximately 4.2 feet and will impact the underground utilities at this location. The impacted utilities identified include:

- Low Pressure Gas
- Sanitary Sewer
- Water
- Telephone with fiberoptics (2)
- City's ITS fiber optic cable
- Overhead Electric.

Although the exact depths of these facilities are not known presently, it is assumed that the utilities will have to be lowered to accommodate the roadway profile.

The proposed alignment will require a significant amount of roadway widening to the east. The layout, the location of the center pier, and the required utility relocations limit the space available for the maintenance of travelways. It is anticipated that during construction, the roadway will have to be reduced to two narrow lanes with occasional short-term roadway shutdowns for restrictive construction operations. Please refer to Figures 5.2a to 5.2d in Appendix G for a four stage maintenance and protection of traffic plan to be used during the reconstruction of the MNRR undergrade bridge over Greenwich Avenue.

Alternate routes include the use of Richmond Hill Avenue, Washington Boulevard, McCullough Street, Pulaski Street, First Stamford Place and Fairfield Avenue. It should also be noted that during the construction period, vertical clearances could be limited. Alternate routes for trucks and emergency vehicles may need to be established if sufficient vertical clearance cannot be maintained during construction.

Pedestrian detours will need to be developed whenever a sidewalk is closed. Pedestrians should be directed to cross at the nearest signalized intersection on either side of the bridge. These detours will be developed during the final design stages.

6. DRAINAGE

6.1. Existing System Conditions

The existing Greenwich Avenue roadway profile increases in grade from the south to the north. From review of the latest available survey, existing runoff north of the intersection with McCullough Street and the I-95 exit ramp is collected by a series of catch basins which convey to a 36-inch RCP. This system outlets to the Mill (Rippowam) River immediately south of the McCullough Street bridge. Please refer to Figure 6.1 for the Drainage Plan, located in Appendix G.

Between the I-95 off ramp/McCullough Street intersection and the MNRR crossing of Greenwich Avenue there is a second system that originates to the west from First

Stamford Place running east across Greenwich Avenue to the Mill River. This system collects runoff on Greenwich Avenue to a point just north of the MNRR crossing, and continues to its terminus at the Mill River just north of the MNRR bridge along the approach embankment.

Under the existing bridge, there are no inlets, however approximately 220 feet downgrade (south) of the bridge there are two double grate inlets on either side of Greenwich Avenue (just north of the Y-intersection with Pulaski Street). These inlets convey captured flows to a 24-inch RCP which in turn ties in with a 54-inch trunkline as found during field location survey along Pulaski Street (record shows 76"x48" elliptical culvert). This trunkline conveys runoff from points west as well as flows captured on Greenwich Avenue south of the MNRR bridge near the Pulaski Street crossing of the Mill River.

6.2. System Constraints and Concepts Considered

Option 1 includes providing a new outlet independent of the existing systems to the north and the south. This option would collect runoff under the bridge with a low point catch basin and two flanker basins on either side of Greenwich Avenue (approximately 6" higher than the sag basin), and create a new outlet point at the Mill River approximately 200-feet to the east of Greenwich Avenue and downstream of the existing railroad bridge over the Mill River. **Benefits** to this option include system independence from adjacent systems and virtually no depth restrictions associated with lowering Greenwich Avenue to improve the vertical clearance under the bridge. Additionally, by removing the contributing area from the Pulaski Street system as described in Option 2, that existing system would be provided relief from the volume of stormwater handled currently. It should be also noted that, due to the lowering of Greenwich Avenue, the First Stamford Place driveway will also be lowered as required. Preliminary investigation to the amount of lowering required indicates that the tail end of the First Stamford Place drainage system may have to be modified to accommodate the proposed grade. **Constraints** associated with this option include additional environmental permitting to establish the outlet and obtaining a property easement for drainage from the Stamford Housing Authority.

Option 2 includes collection of the runoff through a low point catch basin with two flanker basins on either side of Greenwich Avenue (approximately 6" higher than the sag basin) with a connection to the system running south to Pulaski Street and out to the Mill River. **Benefits** to this option include no change in basin flow patterns. The existing system that would be used to tie in to currently collects the runoff from under the bridge. No additional contribution is expected due to construction. Note that this benefit assumes that runoff from First Stamford Place will not be introduced into the proposed system. Based on this, it can be assumed that the existing discharge into the Mill River can be maintained. Additionally all work associated with drainage would fall within the existing Greenwich Avenue rights-of-way.

Option 3 includes collection of the runoff through a low point catch basin with two flanker basins on either side of Greenwich Avenue (approximately 6" higher than the

sag basin) with a connection to the existing 48” outlet near the upstream embankment of the MNRR bridge. **Benefits** to this option include avoiding an additional outlet point to the Mill River and all work associated with drainage would fall within existing Greenwich Avenue highway lines. **Constraints** to this system would be maintaining a negative grade on the flow line within design guidelines (0.5% or greater), and capacity of the existing system.

6.3. Design Criteria

The City of Stamford requires that the storm sewer design to accommodate a 25-year event. All other requirements for storm sewer design will adhere to the Connecticut Department of Transportation Drainage Manual. Specifically:

- low points will be analyzed for a 25-year event
- on-grade gutter flow spread will be one half of the travel lane at maximum
- sag condition gutter flow spread will be all but one lane width at maximum
- storm sewer design will address full flow (non-pressure) conditions

Due to the required lowering of Greenwich Avenue and the impacts this has on the grading of First Stamford Place, all drainage within the work limits on First Stamford Place will have to be removed or abandoned. The drainage system servicing the I-95 exit ramp and McCollough Street will likely be maintained with minimal adjustments to catch basin locations and structure (CB and MH) top-of-frame elevations. The proposed gutter flow, pipe flow, and hydraulic grade line design elements are described as follows:

6.3.1. Gutter flow

Gutter flow to the low points has been calculated from best available information. Drainage areas were delineated to the low point (preliminary and subject to final grading – based on vertical profile). The area contributing to the sag point at 4+35 LT is approximately 0.24 acres. Assuming a minimum time of concentration of 5 minutes for impervious surfaces, returns a 25-year rainfall event at 6.7 ⁱⁿ/_{hr}. Given a 25-year rainfall event at 6.7 in/hr, along with an impervious runoff coefficient of 0.9, a yield of 1.44-cfs is contributed to this point. Using the weir flow calculation for gutter flow depth at a catch basin, it is expected that the flow depth will be 0.16 feet. The area contributing to the sag point at 4+35 RT is approximately 0.38 acres. Using the same rainfall intensity, time of concentration and runoff coefficient, this yields 2.29-cfs of runoff to the low point. Using the weir flow method for gutter flow depth at low points, the expected flow depth would be 0.28 feet.

6.3.2. Pipe flow

Due to lack of information on the drainage system servicing First Stamford Place, a design flow for this portion of the system was computed from a global watershed delineation for the property. Areas outside of the aerial survey limits were supplemented by LIDAR elevation data for the State of Connecticut. This process was necessary since the existing drainage system on First Stamford Place within the

work limits defined by this project will need to be abandoned. The flows developed from this global drainage area delineation were used to size the trunkline of the future First Stamford Place drainage system. With a drainage area of 16.9 acres, an assumed runoff coefficient of 0.5 for 50% impervious, and a conservative time of concentration of 5 minutes, flow rates for the 25-year return period were calculated at 57-cfs. The trunkline for First Stamford Place was sized as a 30-inch RCP set on a 10% flow line slope. Cover provided for this pipe is at minimum 1.9 feet. The proposed inlets are all tied to the 48-inch trunkline of this system with 15-inch RCP. The total system flow at the 48-inch outlet is 55-cfs, which is 0.55% of the inherent capacity.

6.3.3. Hydraulic Grade Line

This system ties to an existing outlet with an elevation of 9.5 on the Mill River. This would be a free-flow outlet as the invert elevation is 5.25 feet greater than the mean high water of Long Island Sound (El. 4.25 feet). As such, the tailwater used to start the hydraulic grade line computation was set between critical depth of the outlet pipe and the crown of the pipe $((d_c+D)/2)$. At the low point beneath the bridge, the hydraulic grade line is computed at 14.05 and 14.64 feet for the right and left sag point inlets, respectively. This result provides a surcharge of 0.03 feet for the right and 0.43 feet for the left. It is anticipated that this surcharge can be resolved through refining the computations for the First Stamford Place driveway. This will require additional investigation into available information or additional survey for the 16 acre contributing area

6.4 Summary of Impacts and Proposed Improvements

Impacts due to the lowering of Greenwich Avenue are most prevalent at the intersection of First Stamford Place with Greenwich Avenue. Grading in this location requires lowering the road upwards of 3 feet, which, from review of available survey reveals existing subsurface drainage systems. Due to these impacts, and the results of field location survey, Option 3 is recommended for design. This option ties into the existing 48-inch outlet pipe upstream of the MNRR bridge. The invert elevation of this outlet pipe is 9.5 feet, well above the mean high water elevation in the Mill River of 4.25 feet. Starting the Hydraulic Grade Line computations at critical depth of the 48-inch pipe (free flow outlet condition), this proposed system will maintain the flows generated from the First Stamford Place driveway and runoff collected at the Greenwich Avenue low point.

7. UTILITIES

It is anticipated that the roadway will require an estimated 3 feet of lowering. At the Greenwich Avenue bridge, the impacted utilities are gas, telephone (overhead wires and underground ducts with fiberoptics), and overhead electric wires. Eleven utility poles could be affected. The City of Stamford also has underground and overhead copper interconnect wiring for their traffic operations within the proposed improvements, which would also be affected. The limits of work and utilities that would be affected are shown

on Figure 7.1, located in Appendix G. The depth of these utilities is not known at this time and it is assumed that the utilities will have to be lowered to accommodate the roadway lowering. Vertical depth information would be required to determine the limits of the actual relocation needs.

8. GEOTECHNICAL

8.1. Summary of Subsurface Conditions

8.1.1 Regional Geology

Published geologic mapping indicates the predominant natural surficial deposit within the project area is glacial till. The glacial till in this area is generally less than 15 feet thick and is absent in some areas. The glacial till is predominantly loose to moderately compact, generally sandy, and commonly stony and, where present, is underlain by bedrock. The underlying bedrock within the project site is mapped as principally Golden Hill Schist (Ogh), which is a gray to silvery, medium to coarse-grained schist and granofels.

8.1.2. Pilot Borings

Three geotechnical borings were performed to preliminarily explore the subsurface conditions at the site. The approximate as-drilled pilot boring locations are shown on Figure 8.1 (located in Appendix G), Greenwich Avenue Pilot Boring Program. Each geotechnical boring was located in the field by taping from existing site features and observed and logged during drilling. Boring Logs are located in Appendix F.

The geotechnical boring depths ranged between about 10 and 16 feet below the existing ground surface at their respective locations. Representative soil samples were obtained continuously to a depth of at least 10 feet and at about 5-foot intervals thereafter. Samples were collected by split-barrel sampling procedures in general accordance with ASTM D 1586 and bedrock was cored in one location to confirm its depth, nature, and quality. An observation well was installed within one of the geotechnical borings to observe longer term groundwater levels.

8.1.3. Subsurface Conditions

The subsurface conditions as interpreted from the geotechnical borings generally consisted of concrete over subbase or fill over natural sand and gravel over bedrock, which is consistent with published geologic data. A detailed description of the subsurface conditions encountered in each of the test borings is contained on the logs.

The concrete and subbase encountered in geotechnical boring B-1 was less than 18 inches thick. The fill encountered in geotechnical boring B-2 was less than 4 feet thick. The fill material was generally classified as medium dense fine to coarse sand with some silt and trace roots.

8.1.4. Soil

Sand and gravel immediately underlies the surficial materials described above and was between 2 and 8 feet thick. The sand and gravel was generally classified as loose to very dense, fine to coarse sand with varying fractions of silt and gravel.

Bedrock was observed below the sand and gravel at depths between approximately 6 to 11 feet below the existing ground surface at the boring locations. The depth to bedrock was inferred at geotechnical borings B-1 and B-2 based on drilling effort. However, the depth, nature, and quality of the bedrock were confirmed by coring at geotechnical boring B-3. At this location the bedrock generally consisted of very poor quality, moderately hard, slightly weathered, whitish gray, medium grained gneiss.

8.1.5. Groundwater

Groundwater was observed in geotechnical boring B-1 at a depth of approximately 8 feet below the existing ground surface during drilling; however, groundwater was not observed in either of the other geotechnical borings or in the observation well. Fluctuations in the observed groundwater level occur due to variation in precipitation, temperature, and other factors different from those existing at the time the measurements were made.

8.2. Geotechnical Construction Issues

Based on the above bridge rehabilitation concepts, the primary geotechnical issues that are anticipated will be the following:

- Protection of active railroad operations and of the existing tracks is required.
- Protection of existing structures during construction. These structures include railroad catenary structures, overhead and underground utilities, buildings and retaining walls.
- Management and disposal of excavated materials. Since both abutments are being removed and replaced, mini-piles will be drilled and significant excavation of the embankment soils will be required. Drill spoils will be disposed of in accordance with State and Local requirements. Excavated soils may be able to be reused elsewhere on the project depending on the nature and quality of the materials. Otherwise, they will be disposed of in accordance with State and Local requirements.

8.3. Foundation Recommendations

Based on the information available, drilled mini-piles are recommended for the support of the proposed abutments and pier. The drilled mini-piles will have permanent casing to the top of bedrock and will develop their capacity in the underlying bedrock. A

continuous reinforcing bar will be installed from the bottom of the rock socket to the top of the pile. The rock socket and casing will be filled with tremie placed grout.

The mini-piles will be designed to carry the required design load in the rock socket and will be sized and reinforced appropriately to resist any other imposed loads (e.g. uplift, lateral, etc.). Based on preliminary design loads and subsurface conditions, it is estimated that rock socket lengths will be approximately 10 to 15 feet and overall mini-pile lengths will be approximately 25 to 40 feet for the center pier and abutments, respectively.

9. ENVIRONMENTAL

9.1 Required Environmental Permits

Work activities proposed for Greenwich Avenue appear to fall outside of the FEMA regulated Floodplain and Floodway, therefore no Flood Management Certification is anticipated for the project. Please refer to Figure 9.1 for the FEMA 100-year Floodplain, located in Appendix G.

The project site does fall within the Coastal Boundary indicating that a DEP administered Coastal Area Management Permit (CAM) is required

Wetland impacts are not expected for this urban setting, consequently local or tidal wetland permits are not anticipated.

The total project footprint is expected to be greater than 1 acre which will trigger the requirements for a DEP administered General Permit for *Stormwater and Dewatering Wastewaters from Construction Activities*.

10. SUMMARY AND CONCLUSIONS

In order to accommodate the rising traffic demands within the City of Stamford and to open up north-south access, it is necessary to address the bottlenecking that occurs at the Metro-North Railroad undergrade bridge. Additional travel lanes can be added upon the reconstruction of the undergrade bridge. The proposed new underpass will provide two eight-foot sidewalks, two-foot shoulders, three 11-foot lanes traveling in the northbound direction and two 11-foot lanes traveling in the southbound direction.

The new structure will comprise of two spans supported by abutments and a center pier. The depth of structure will depend upon the structure type that is selected. After careful consideration of several structure types for the study, four were eliminated due to a lack of feasibility. Two structure types remain as viable options: the precast concrete-encased beams and the multi-steel girder ballasted steel plate deck option. The structure type selected will determine the depth at which Greenwich Avenue will be lowered to obtain the minimum vertical clearance of 14'-6". The depth will determine the extent of the impacts upon nearby intersections, roadways and properties.

Impacts to rail operations will be minimized by only taking one Metro-North railroad track out of service at a time. But by constructing the bridge in one track width segments, the construction access is very limited and with the limited overhead space due to the catenaries, a top-down methodology is recommended for construction of the abutments. The west abutment will be a reinforced concrete stub abutment on drilled mini-piles. The east abutment will be a conventional cantilevered full-height reinforced concrete abutment founded on assumed spread footings. As mentioned previously, these abutments will be constructed in stages, one track width at a time.

The proposed piers will be cast in place and would comprise of a footing, pier cap, and circular columns also to be founded on drilled mini-piles.

Throughout the construction process, Greenwich Avenue will remain open to traffic. Two travel lanes will be maintained, one in each direction.

APPENDIX A – HIGHWAY DESIGN CRITERIA

Greenwich Avenue is classified as a Minor Urban Arterials roadway. The Connecticut Department of Transportation’s criterion for a Minor Urban Arterial roadway classification is shown in the following table. Built up designation would apply based on the location of Greenwich Avenue.

Key design criteria are outlined in the table below.

Greenwich Avenue – Minor Urban Arterial			
Design Element		Recommended Design Value	Proposed Design Value
Design Speed		30 – 40 mph	20 mph
Travel Lane Width		10’ – 12’	11’
Shoulder Width	Right	4’ – 8’	N.A.
	Left	2’ – 4’	2’
Cross Slope		1.5 – 2.0%	2.0%
Turn Lane Width		11’	11’
Turn Lane Shoulder Width		2’ – 4’	2’ adjacent to curb
Sidewalk Width		5’ Minimum	5’
Bicycle Lane	Width	5’	5’
	Cross Slope	2.0%	
Roadside Clear Zones		14’	10’
Stopping Sight Distance		200’	>200’ ⁽²⁾
Intersection Sight Distance		355’	265’ ⁽³⁾
Decision Sight Distance (Stop)		490’	490’
Minimum radius (e=4.0%)		230’	382’
Superelevation Maximum		4.0%	None
Maximum Grade		9%	8%
Minimum Grade		0.5%	1.8%
Vertical Curvature (K-value)	Crest	19	16
	Sag	37	8.6
Minimum Vertical Clearance Under New Bridge		16’-3’’ ⁽¹⁾	14’-6’’
Source: Connecticut Department of Transportation Highway Design Manual, 2003 Edition			
(1) 14’-6’’ minimum vertical clearance used.			
(2) Based on illuminated highway in sag vertical curve			
(3) Traffic Signal controlled			

APPENDIX B – BRIDGE DESIGN CRITERIA

- Structure Layout
 - Bridge will span over the proposed roadway cross section conforming to the City of Stamford requirements
 - Abutments will be located outside of proposed sidewalks
 - Pier is located between the northbound and southbound lanes
 - Substructure units will be parallel or tangent to the roadway baseline and parallel to each other

- Bridge Type
 - Superstructure
 - Bridge will consist of two simple spans supported on abutments and a pier
 - Primary replacement bridge choice will be Metro-North's preferred ballasted deck
 - Structure types considered:
 - Half-through Plate Girders
 - Two-Girder Ballasted Concrete Deck
 - Four-Girder Ballasted Steel Plate Deck
 - Multi Concrete-Encased Beams
 - Prestressed Butted Box Beams
 - Design considerations:
 - Girders are designed for strength
 - Girders also have a service criteria
 - Maximum deflection is equal to $L/640$
 - Structure type used for the purposes of this report is the multi-concrete encased beams
 - Access walkways will be provided for the purposes of servicing the tracks
 - Substructure
 - The abutments and the pier proposed are to be constructed using cast-in-place concrete. Precast concrete modules will be considered for an accelerated construction schedule.
 - Foundation
 - The footing of the abutment will be founded on mini-piles

- The footing for the pier will be on a spread footing if the proper width can be obtained given the constraints posed by M&PT. If a spread footing is not attainable, mini-piles will be used.

- Structure Depth
 - Structure depth is based on a top of rail elevation to bottom of beam depth and is based on the following assumptions:
 - Rail height – 7 5/8” (typ.)
 - Depth of Concrete Tie – 8.5” (typ.)
 - Depth of Ballast below railroad tie – 8.5” (typ.) bridge was designed for an additional 3.5” to be added in the future
 - Ballast Mat – 1” (typ.)
 - Concrete Deck with Haunch – 13” (specific to the 2-girder ballasted concrete deck structure type)
 - Steel Plate – 1.5” (specific to the 4-girder ballasted steel plate deck structure type)
 - Depth of Beam (this dimension is in addition to the previously mentioned items with the exception of the half-thru girder option. For the half-thru girder option, the structure depth is equivalent to the beam depth as the top flange is at the top of rail elevation.)

- Construction
 - Stage construction is based on single track outages
 - For the purposes of this report, tracks are taken out of service from north to south
 - Construction of the abutments will use a top-down methodology
 - Catenary wires will remain in place during construction and will be maintained and protected

- Rail Geometry
 - Existing horizontal and vertical alignment will be maintained

APPENDIX C – CONSTRUCTION SCHEDULE

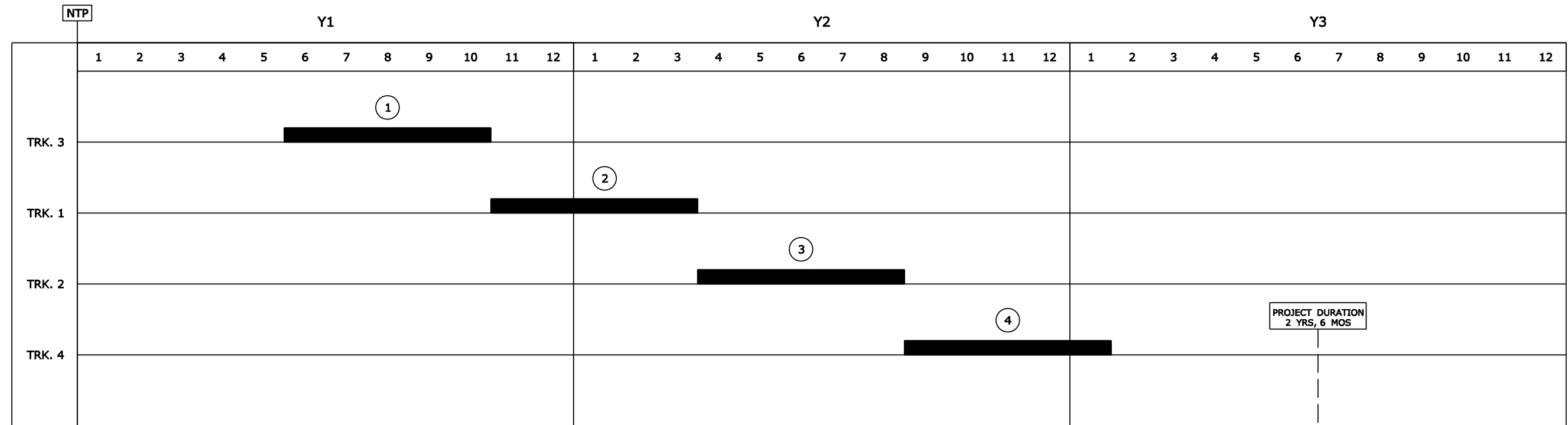

STAGE NO.	MOBILIZATION STAGE	1	2	3	4
CALENDAR DAYS	150	150	150	150	150

GREENWICH AVENUE (ROAD WORK)	REMOVE EX. ABUTMENTS	INSTALL ROADWAY
------------------------------	----------------------	-----------------

LEGEND:



SOUTH STAMFORD ACCESSIBILITY & MNRR BRIDGE REPLACEMENT FEASIBILITY STUDY

GREENWICH AVENUE TRACK OUTAGE SCHEDULE

APPENDIX D – CONSTRUCTION COST ESTIMATES



South Stamford Accessibility and MNRR Bridge Replacement Feasibility Study

Stamford, Connecticut

State Project No. 135-301

**PRELIMINARY ENGINEERING CONSTRUCTION COST ESTIMATE
GREENWICH AVENUE**

Item No.	Description	Unit	Unit Price	Alternative 1		Alternative 2	
				Quantity	Price	Quantity	Price
				Two Span Top Down Concrete-Encased Steel Beams		Two Span Top Down Multi Steel Girders	
Highway & Traffic Items							
1.	Earth Excavation	CY	\$26.00	7,953	\$206,778.00	7,953	\$206,778.00
2.	Rock Excavation	CY	\$50.00	884	\$44,200.00	884	\$44,200.00
3.	Drainage; Pipe (15")	LF	\$60.00	290	\$17,400.00	290	\$17,400.00
4.	Drainage; Pipe (30")	LF	\$90.00	90	\$8,100.00	90	\$8,100.00
5.	Drainage; Pipe (48")	LF	\$185.00	80	\$14,800.00	80	\$14,800.00
6.	Drainage; Catch Basins	EA	\$2,800.00	6	\$16,800.00	6	\$16,800.00
7.	Manhole	EA	\$4,500.00	3	\$13,500.00	3	\$13,500.00
8.	Bit. Driveway / Parking Lot	SY	\$40.00	1,111	\$44,440.00	1,111	\$44,440.00
9.	HMA - Superpave	T	\$105.00	2,261	\$237,405.00	2,261	\$237,405.00
10.	Processed Aggregate Base	T	\$35.00	2,261	\$79,135.00	2,261	\$79,135.00
11.	Subbase	T	\$35.00	2,574	\$90,090.00	2,574	\$90,090.00
12.	Formation of Subgrade	SY	\$5.00	7,721	\$38,605.00	7,721	\$38,605.00
13.	Temporary PCBC	LF	\$42.00	370	\$15,540.00	370	\$15,540.00
14.	Impact Attenuators	EA	\$25,000.00	2	\$50,000.00	2	\$50,000.00
15.	Curbing; Concrete	LF	\$30.00	2,672	\$80,160.00	2,672	\$80,160.00
16.	Concrete Sidewalk	SF	\$15.00	14,712	\$220,680.00	14,712	\$220,680.00
17.	Trafficperson (City/State Police Officer)	HR	\$75.00	15,360	\$1,152,000.00	15,360	\$1,152,000.00
18.	Roadway Lighting	LF	\$40.00	100	\$4,000.00	100	\$4,000.00
19.	Traffic Signals; New	EA	\$200,000.00	1	\$200,000.00	1	\$200,000.00
20.	Traffic Signals; Minor Modification	EA	\$30,000.00	1	\$30,000.00	1	\$30,000.00
Section Sub-Total					\$2,563,633.00		\$2,563,633.00
Structures Items - Undergrade Bridge							
21.	Structure Excavation - Earth (Complete)	CY	\$90.00	4,500	\$405,000.00	4,500	\$405,000.00
22.	Ballast	CY	\$175.00	390	\$68,250.00	460	\$80,500.00
23.	Ballast Mat	SF	\$15.00	7,360	\$110,400.00	8,640	\$129,600.00
24.	Pervious Structure Backfill	CY	\$105.00	1,100	\$115,500.00	1,100	\$115,500.00
25.	Granular Fill	CY	\$40.00	110	\$4,400.00	110	\$4,400.00
26.	Removal of Superstructure	LS	\$200,000.00	1	\$200,000.00	1	\$200,000.00
27.	Removal of Substructure	LS	\$150,000.00	1	\$150,000.00	1	\$150,000.00
28.	Steel-Laminated Elastomeric Bearings	CI	\$3.00	87,400	\$262,200.00	62,100	\$186,300.00
29.	Class "A" Concrete	CY	\$850.00	670	\$569,500.00	640	\$544,000.00
30.	Class "F" Concrete	CY	\$1,250.00	290	\$362,500.00	250	\$312,500.00
31.	Architectural Formliner	SY	\$400.00	120	\$48,000.00	120	\$48,000.00
32.	Deformed Steel Bars	LBS	\$1.60	83,800	\$134,080.00	80,000	\$128,000.00
33.	Deformed Steel Bars (Epoxy Coated)	LBS	\$1.65	60,000	\$99,000.00	75,000	\$123,750.00
34.	Structural Steel	LBS	\$3.25	0	\$0.00	1,665,000	\$5,411,250.00
35.	Precast Concrete Encased Steel Girders	LF	\$2,100.00	2,280	\$4,788,000.00	0	\$0.00
36.	Drilled Mini-Piles	EA	\$10,000.00	60	\$600,000.00	50	\$500,000.00
37.	Drilled Shaft	LF	\$2,000.00	80	\$160,000.00	80	\$160,000.00
38.	Temporary Earth Retaining System (RR)	SF	\$160.00	10,800	\$1,728,000.00	10,800	\$1,728,000.00
39.	Lead Health Protection Program	LS	\$100,000.00	1	\$100,000.00	1	\$100,000.00
Section Sub-Total					\$9,904,830.00		\$10,326,800.00
Project Sub-Total							
Highway & Traffic + Structure					\$12,468,463.00		\$12,890,433.00



South Stamford Accessibility and MNRR Bridge Replacement Feasibility Study

Stamford, Connecticut
State Project No. 135-301

**PRELIMINARY ENGINEERING CONSTRUCTION COST ESTIMATE
GREENWICH AVENUE**

Item No.	Description	Unit	Unit Price	Alternative 1		Alternative 2	
				Quantity	Price	Quantity	Price
				Two Span Top Down Concrete-Encased Steel Beams		Two Span Top Down Multi Steel Girders	
Percentage Based Items (applied to Project Sub-Total)							
1.	Clearing and Grubbing Roadway	@		2%	\$249,369.26	2%	\$257,808.66
2.	M & P of Traffic	@		4%	\$498,738.52	4%	\$515,617.32
3.	Mobilization	@		7.5%	\$935,134.73	7.5%	\$966,782.48
4.	Construction Staking	@		1%	\$124,684.63	1%	\$128,904.33
5.	Minor Items	@		25%	\$3,117,115.75	25%	\$3,222,608.25
Section Sub-Total					\$4,925,042.89		\$5,091,721.04

Project Total					
Project Sub-Total + Percentage Based Items				\$17,393,505.89	\$17,982,154.04

Utility Relocation Costs							
1.	Utility Relocation	Est.	\$2,191,000.00	1	\$2,191,000.00	1	\$2,191,000.00
Section Sub-Total				\$2,191,000.00	\$2,191,000.00		

Railroad Costs							
1.	RR Force Account Work ^{1&2}	@		40%	\$3,961,932.00	40%	\$4,130,720.00
Section Sub-Total				\$3,961,932.00	\$4,130,720.00		

Incidentals and Contingencies (applied to Project Total)							
1.	Incidentals	@		23%	\$4,000,506.35	23%	\$4,135,895.43
2.	Contingencies	@		10%	\$1,739,350.59	10%	\$1,798,215.40
Section Sub-Total				\$5,739,856.94	\$5,934,110.83		

Cost of Bridge Replacement (2011)		\$29,286,294.83	\$30,237,984.87
SAY		\$29,300,000.00	\$30,200,000.00

Inflation to Mid-Point of Construction					
Price Adjustment (adjust to 2016)	5 years @	5%	\$8,091,263.29	5%	\$8,354,197.71

Cost of Bridge Replacement (2016)		\$37,377,558.12	\$38,592,182.57
SAY		\$37,400,000.00	\$38,600,000.00

Project Cost Escalation Footnotes:

- Estimated construction cost shown above is based on 2011 prices.
- Rate of construction cost escalation is estimated at 5% per year, per CTDOT Estimating Guidelines, calculated to the mid-point of construction, which is anticipated to be 2016 based on an anticipated 2014 start of construction. Accordingly, the cost escalation factor is 1.28.

NOTES:

- MNRR Force Account value is based on 40% of the sum of the total structure work for the Undergrade Bridge + 25% minor items applied to the total structure work.
- MNRR Force Account includes the cost of Metro North personnel and railroad work associated with the removal of the existing bridge and construction of the proposed bridge, including removal & replacement of railroad tracks, communications & signals, and catenary pole relocation where applicable.
- Items NOT included in this estimate:
 - Building Demolition / ROW acquisitions
 - Environmental Remediation
 - Environmental Studies (20% of Environmental Remediation Costs)

APPENDIX E – DRAINAGE COMPUTATIONS

Hydraflow Storm Sewers Plan

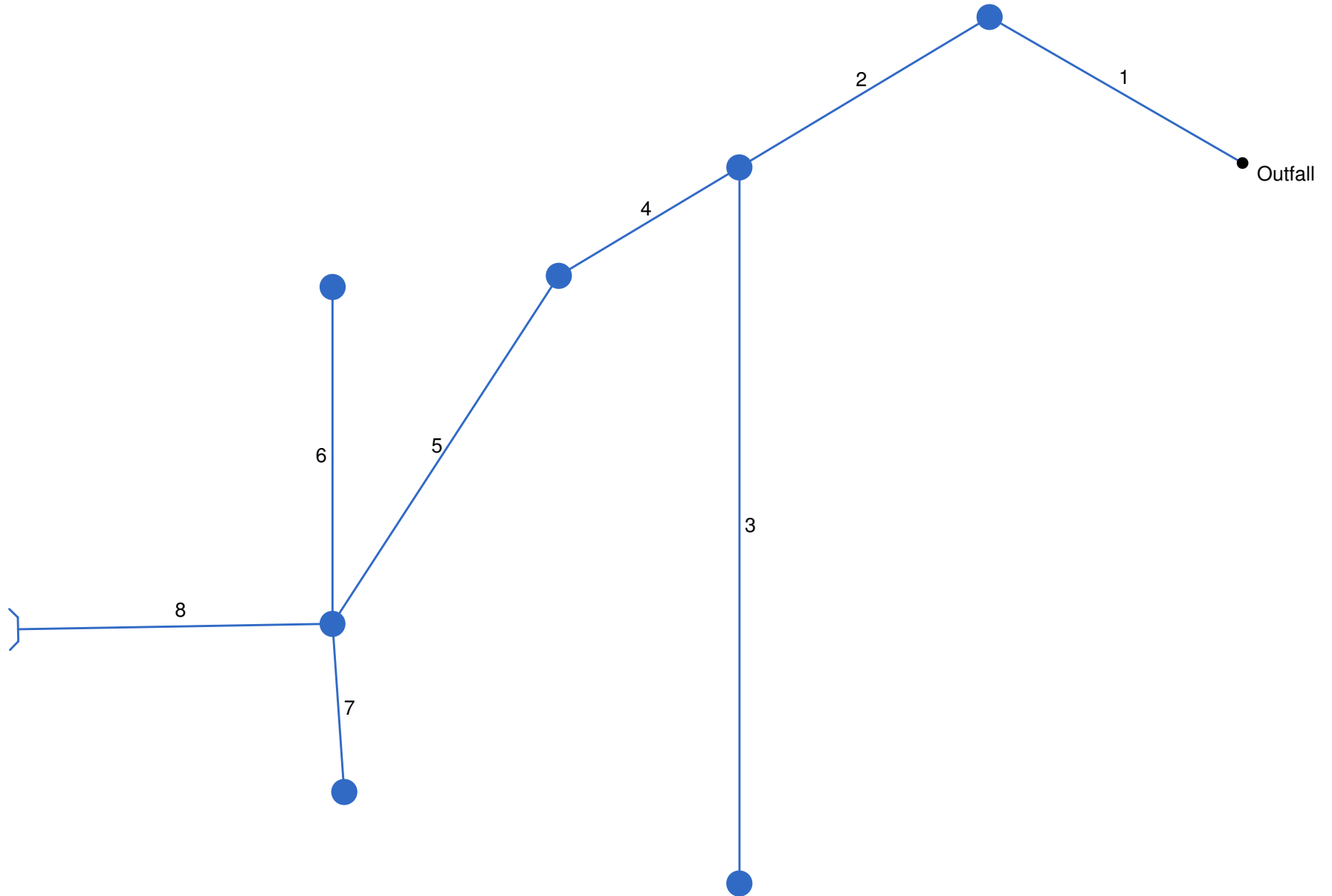

Project File: GREENWICH_DRAINAGE.stm

Number of lines: 8

Date: 09-17-2010

Storm Sewer Tabulation

Station		Len (ft)	Drng Area		Rnoff coeff (C)	Area x C		Tc		Rain (l) (in/hr)	Total flow (cfs)	Cap full (cfs)	Vel (ft/s)	Pipe		Invert Elev		HGL Elev		Grnd / Rim Elev		Line ID
Line	To Line		Incr (ac)	Total (ac)		Incr	Total	Inlet (min)	Syst (min)					Size (in)	Slope (%)	Dn (ft)	Up (ft)	Dn (ft)	Up (ft)	Dn (ft)	Up (ft)	
1	End	49	0.00	17.62	0.00	0.00	9.10	0.0	7.5	6.1	55.16	99.93	5.45	48	0.41	9.50	9.70	12.60	12.61	9.50	24.11	EXISTING OUTL
2	1	49	0.00	17.62	0.00	0.00	9.10	0.0	7.3	6.1	55.53	128.4	5.39	48	0.68	9.80	10.13	13.06	13.02	24.11	20.70	EXISTING 48
3	2	119	0.38	0.38	0.90	0.34	0.34	5.0	5.0	6.7	2.29	4.80	1.87	15	0.47	10.37	10.93	13.92	14.05	20.70	14.02	
4	2	35	0.00	17.24	0.00	0.00	8.76	0.0	7.1	6.1	53.71	136.7	4.85	48	0.77	10.13	10.40	13.58	13.56	20.70	19.50	
5	4	69	0.00	17.24	0.00	0.00	8.76	0.0	6.9	6.2	54.24	110.8	5.08	48	0.51	10.40	10.75	13.75	13.76	19.50	15.55	
6	5	56	0.10	0.10	0.90	0.09	0.09	5.0	5.0	6.7	0.60	17.29	1.51	15	6.11	12.11	15.53	14.65	15.84	15.55	18.97	
7	5	28	0.24	0.24	0.90	0.22	0.22	5.0	5.0	6.7	1.45	4.95	1.18	15	0.50	11.16	11.30	14.63	14.64	15.55	14.38	
8	5	52	16.90	16.90	0.50	8.45	8.45	5.0	5.0	6.7	56.61	140.2	11.65	30	9.96	10.75	15.95	14.20	18.32	15.55	21.00	

Project File: GREENWICH_DRAINAGE.stm

Number of lines: 8

Run Date: 09-17-2010

NOTES: Intensity = 101.98 / (Inlet time + 15.80) ^ 0.90; Return period = 25 Yrs. ; c = cir e = ellip b = box

Hydraulic Grade Line Computations

Line	Size (in)	Q (cfs)	Downstream								Len (ft)	Upstream								Check		JL coeff (K)	Minor loss (ft)
			Invert elev (ft)	HGL elev (ft)	Depth (ft)	Area (sqft)	Vel (ft/s)	Vel head (ft)	EGL elev (ft)	Sf (%)		Invert elev (ft)	HGL elev (ft)	Depth (ft)	Area (sqft)	Vel (ft/s)	Vel head (ft)	EGL elev (ft)	Sf (%)	Ave Sf (%)	Enrgy loss (ft)		
1	48	55.16	9.50	12.60	3.10	10.44	5.28	0.43	13.03	0.141	49	9.70	12.61	2.91	9.80	5.63	0.49	13.10	0.162	0.151	0.073	0.90	0.44
2	48	55.53	9.80	13.06	3.26	10.95	5.07	0.40	13.45	0.129	49	10.13	13.02	2.89	9.73	5.71	0.51	13.53	0.167	0.148	0.072	0.88	0.45
3	15	2.29	10.37	13.92	1.25	1.23	1.87	0.05	13.97	0.107	119	10.93	14.05	1.25	1.23	1.87	0.05	14.10	0.107	0.107	0.128	1.00	0.05
4	48	53.71	10.13	13.58	3.45	11.52	4.66	0.34	13.91	0.110	35	10.40	13.56	3.16	10.65	5.04	0.40	13.96	0.128	0.119	0.042	0.49	0.19
5	48	54.24	10.40	13.75	3.35	11.25	4.82	0.36	14.12	0.117	69	10.75	13.76	3.01	10.14	5.35	0.44	14.20	0.145	0.131	0.090	1.00	0.44
6	15	0.60	12.11	14.65	1.25	1.23	0.49	0.00	14.65	0.007	56	15.53	15.84 j	0.31**	0.24	2.53	0.10	15.94	0.405	0.206	n/a	1.00	n/a
7	15	1.45	11.16	14.63	1.25	1.23	1.18	0.02	14.65	0.043	28	11.30	14.64	1.25	1.23	1.18	0.02	14.66	0.043	0.043	0.012	1.00	0.02
8	30	56.61	10.75	14.20	2.50	4.81	11.54	2.07	16.27	1.624	52	15.95	18.32	2.37**	4.81	11.76	2.15	20.47	1.406	1.515	n/a	1.00	n/a

Project File: GREENWICH_DRAINAGE.stm

Number of lines: 8

Run Date: 09-17-2010

Notes: ; ** Critical depth.; j-Line contains hyd. jump. ; c = cir e = ellip b = box

APPENDIX F – BORING LOGS

		Connecticut DOT Boring Report		Hole No.: B-1
Inspector: R. Janeiro	Town: Stamford	Project No.: 0101-025.00		Stat./Offset:
Engineer: J. Kidd	Route No.:	Bridge No.:		Northing:
Start Date: 8-30-10			Easting:	
Finish Date: 8-30-10			Surface Elevation:	

Project Description: Greenwich Avenue, Pilot Boring Program

Casing Size/Type: 3"/NW	Sampler Type/Size: SS/1-3/8"	Core Barrel Type: NX
Hammer Wt.: 300 lb. Fall: 24in.	Hammer Wt.: 140 lb. Fall: 30 in.	

Groundwater Observations: @8.5 ft.

Depth (ft)	SAMPLES					Generalized Strata Description	Material Description and Notes	Elevation (ft)	
	Sample Type/No.	Blows on Sampler per 6 inches							Pen. (in.)
0							Concrete Subbase		
	S-1	2	1	3	5	24	8	Sand with Gravel & Silt	S-1: Loose, brown Top 2 ": fine to coarse GRAVEL (subbase) Bottom 6 ": fine to coarse SAND, some Silt, little fine to coarse Gravel
	S-2	26	13	9	11	24	11		S-2: Medium dense, brown fine to coarse SAND, some Silt, trace fine Gravel
5	S-3	8	6	7	29	24	9		S-3: Medium dense, brown fine to coarse SAND, some fine to coarse Gravel, little Silt
	S-4	26	20	30	32	24	18		S-4: Dense, Top 10": brown fine to coarse SAND, some Silt, some fine Gravel Bottom 8": dark gray fine to coarse SAND and SILT, little fine Gravel
	S-5	100/3"				3	2	Weathered Rock	S-5: GNEISS rock fragments
10									
	S-6	100/1"				1	0		S-6: No recovery (rock fragments in wash)
15									END OF BORING 15.5ft
20									

Sample Type: S = Split Spoon C = Core UP = Undisturbed Piston V = Vane Shear Test
Proportions Used: Trace = 1 - 10%, Little = 10 - 20%, Some = 20 - 35%, And = 35 - 50%

Total Penetration in Earth: 15.5ft Rock: 0ft	NOTES: Piece of coarse Gravel jammed in S-1, S-2, S-3 and S-4; Advanced open hole until 9.25 b.g., casing driven down to EOB.	Sheet 1 of 1
No. of Soil Samples: 6 No. of Core Runs: 0		SM-001-M REV. 1/02

Connecticut DOT Boring Report		Hole No.: B-2(OW)
Inspector: R. Janeiro	Town: Stamford	Stat./Offset:
Engineer: J. Kidd	Project No.: 0101-025.00	Northing:
Start Date: 9-2-10	Route No.:	Easting:
Finish Date: 9-3-10	Bridge No.:	Surface Elevation:

Project Description: Greenwich Avenue, Pilot Boring Program

Casing Size/Type: 3"/NW	Sampler Type/Size: SS/1-3/8"	Core Barrel Type: NX
Hammer Wt.: 300 lb. Fall: 24in.	Hammer Wt.: 140 lb. Fall: 30 in.	

Groundwater Observations: @None observed

Depth (ft)	SAMPLES					Generalized Strata Description	Material Description and Notes	Well Construction	Elevation (ft)					
	Sample Type/No.	Blows on Sampler per 6 inches								Pen. (in.)	Rec. (in.)	RQD %		
0														
	S-1	8	12	12	9	24	6			Fill	S-1: Medium dense, brown fine to medium SAND, some Silt, trace coarse Sand, trace Roots			
	S-2	10	10	11	17	24	0				S-2: No recovery			
5	S-3	32	51	48	57	24	14			Sand with Gravel & Silt	S-3: Very dense, reddish brown fine to coarse GRAVEL and fine to coarse SAND, little Silt			
	S-4	100/4"				4	2				Weathered Rock	S-4: GNEISS rock fragments in tip of sample		
	S-5	100/2"				2	0					S-5: No recovery		
10											END OF BORING 10ft			
15														
20														

Sample Type: S = Split Spoon C = Core UP = Undisturbed Piston V = Vane Shear Test
 Proportions Used: Trace = 1 - 10%, Little = 10 - 20%, Some = 20 - 35%, And = 35 - 50%

Total Penetration in Earth: 10ft Rock: 0ft	NOTES: Severe auger chatter 7' to 8'; Piece of coarse gravel jammed in S-1, S-2 and S-3	Sheet 1 of 1
No. of Soil Samples: 5	No. of Core Runs: 0	SM-001-M REV. 1/02

		Connecticut DOT Boring Report		Hole No.: B-3
Inspector: D. Lu	Town: Stamford	Project No.: 0101-025.00		Stat./Offset:
Engineer: J. Kidd	Route No.:	Bridge No.:		Northing:
Start Date: 9-3-10			Easting:	
Finish Date: 9-3-10			Surface Elevation:	

Project Description: Greenwich Avenue, Pilot Boring Program

Casing Size/Type: 3"/NW	Sampler Type/Size: SS/1-3/8"	Core Barrel Type: NX
Hammer Wt.: 300 lb. Fall: 24in.	Hammer Wt.: 140 lb. Fall: 30 in.	

Groundwater Observations: @None observed

Depth (ft)	SAMPLES					Generalized Strata Description	Material Description and Notes	Elevation (ft)	
	Sample Type/No.	Blows on Sampler per 6 inches							Pen. (in.)
0	S-1	17	19	13	14	24	6	Silty Sand and Gravel	S-1: Dense, brown fine to medium SAND, some Silt, trace fine Gravel S-2: Very dense, brown fine to medium SAND, some Silt, trace fine to coarse Gravel S-3: Very dense, brown fine to medium SAND and fine to coarse GRAVEL, little Silt S-4: Very dense, brown to gray fine SAND and SILT, little fine to coarse Gravel S-5: Very dense, brown to gray fine SAND and SILT, little fine to coarse Gravel S-6: Very dense, brown to gray fine to coarse GRAVEL, little fine Sand and Silt
	S-2	13 100/3"				9	2		
5	S-3	24	32	22	10	24	6		
	S-4	18	28	32	30	24	14		
	S-5	16	25	27	47	24	12		
10	S-6	66	72	50/1"		13	6	Bedrock	
	C-1					60	39		23
15									END OF BORING 16ft
20									

Sample Type: S = Split Spoon C = Core UP = Undisturbed Piston V = Vane Shear Test
 Proportions Used: Trace = 1 - 10%, Little = 10 - 20%, Some = 20 - 35%, And = 35 - 50%

Total Penetration in Earth: 11ft Rock: 5ft	NOTES: Auger chattered at approximately 2.5' b.g. Cutting at 3' is Fine to Coarse Gravel and Sand	Sheet 1 of 1
No. of Soil Samples: 6	No. of Core Runs: 1	SM-001-M REV. 1/02

APPENDIX G - FIGURES

Highway

Figure 2.1 – Project Area

Figure 2.2 – Roadway Plan

 Figure 2.2.1 – Parking Lot Layout

Figure 2.3.1 – Greenwich Ave, Vertical Profile

Figure 2.3.2 – First Stamford Place, Vertical Profile

Figure 2.3.3 – McCullough Street, Vertical Profile

Figure 2.4.1 – Critical Cross Sections, Greenwich Avenue

Figure 2.4.2 – Critical Cross Sections, Greenwich Avenue and First Stamford Place

Figure 2.5 – Greenwich Avenue Typical Section

Rail Operations

Figure 3.1a-d – Rail Staging and Sequencing Plans for Bridge 03680R

Bridge 03680R

Figure 4.1 – Proposed Plan & Elevation

Figure 4.2 – Typical Sections, Alternate 1

Figure 4.3 – Typical Sections, Alternate 2

Figure 4.4 – Construction Staging Sections

Figure 4.5 – Construction Staging Plans

Figure 4.6 – Abutments

Traffic

Figure 5.1 – Preliminary Traffic Signal Plans

Figure 5.2.1-4 – Maintenance and Protection of Traffic Staging

Drainage

Figure 6.1 – Drainage Plan

Utilities

Figure 7.1 – Utility Plan

Geotechnical

Figure 8.1 – Boring Plan

Environmental

Figure 9.1 – 100 Year FEMA Floodplain

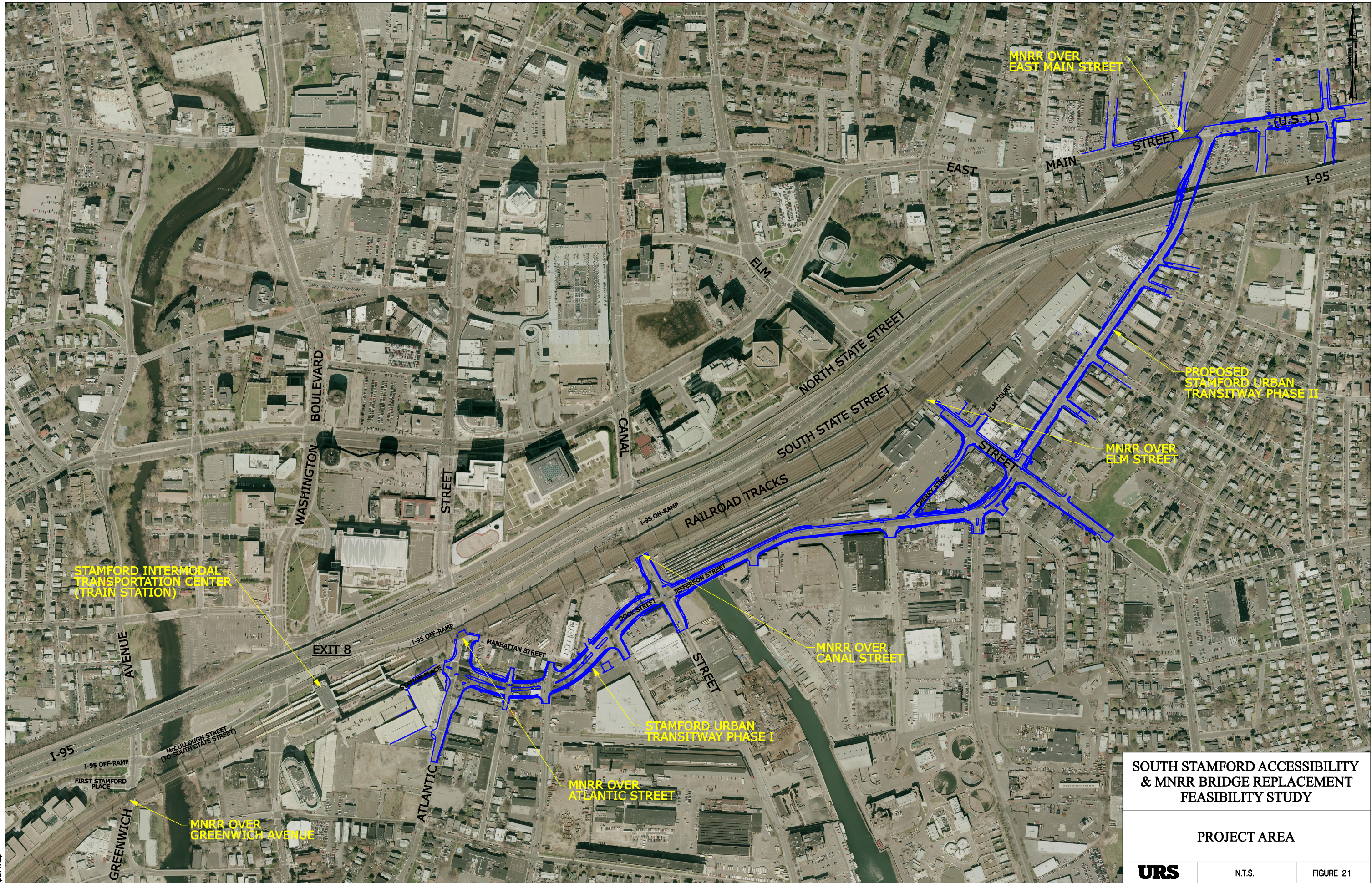

**SOUTH STAMFORD ACCESSIBILITY
& MNRR BRIDGE REPLACEMENT
FEASIBILITY STUDY**

PROJECT AREA

URS

N.T.S.

FIGURE 2.1

FILES
DATES

APPROX. LIMIT OF WORK TO MEET EXISTING PROFILE GRADE

APPROX. LIMIT OF WORK TO MEET EXISTING PROFILE GRADE

APPROX. LIMIT OF WORK TO MEET EXISTING PROFILE GRADE

APPROX. LIMIT OF WORK TO MEET EXISTING ROAD & SIDEWALK WIDTH

APPROX. LIMIT OF WORK AT EXISTING BRIDGE ABUTMENT

METRO NORTH RAILROAD

GREENWICH AVE

FIRST STAMFORD PLACE

I-95 OFF RAMP

I-95

SIDEWALK

PULASKI ST

MCCULLOUGH ST

MILL RIVER

5'-10" SIDEWALK (TYP.)
3' GRASS UTILITY SHELF (TYP.)
5' BIKE LANE (TYP.)

MAINTAIN TWO LANES OF TRAFFIC ON EXISTING WIDTH

2' SHOULDER AT CENTER MEDIAN

11' LANE (TYP.)

0+00 0+50 1+00 1+50 2+00 2+50 3+00 3+50 4+00 4+50 5+00 5+50 6+00 6+50 7+00 7+50

50' TAPER - 1 LANE TO 2 LANES

RECONFIGURE PARKING LOTS TO PROVIDE 16 SPACES (MIN.)

5' BIKE LANE (TYP.)

5'-10" SIDEWALK (TYP.)

END BIKE LANE - BEGIN SHOULDER

TAPER GRASS SHELF 3' TO 0' (TYP. AT SOUTH APPROACH)

5' SHLD

5' SIDEWALK (TYP.)

50' TAPER - 2 LANES TO 3 LANES TO AVOID BUILDING

SOUTH STAMFORD ACCESSIBILITY & MNRR BRIDGE REPLACEMENT FEASIBILITY STUDY

GREENWICH AVENUE ROADWAY PLAN

ROADWAY PLAN
SCALE: 1" = 60'

URS

SCALE: 1" = 60'

FIGURE 2.1

\$FILES\$
3/1/2011

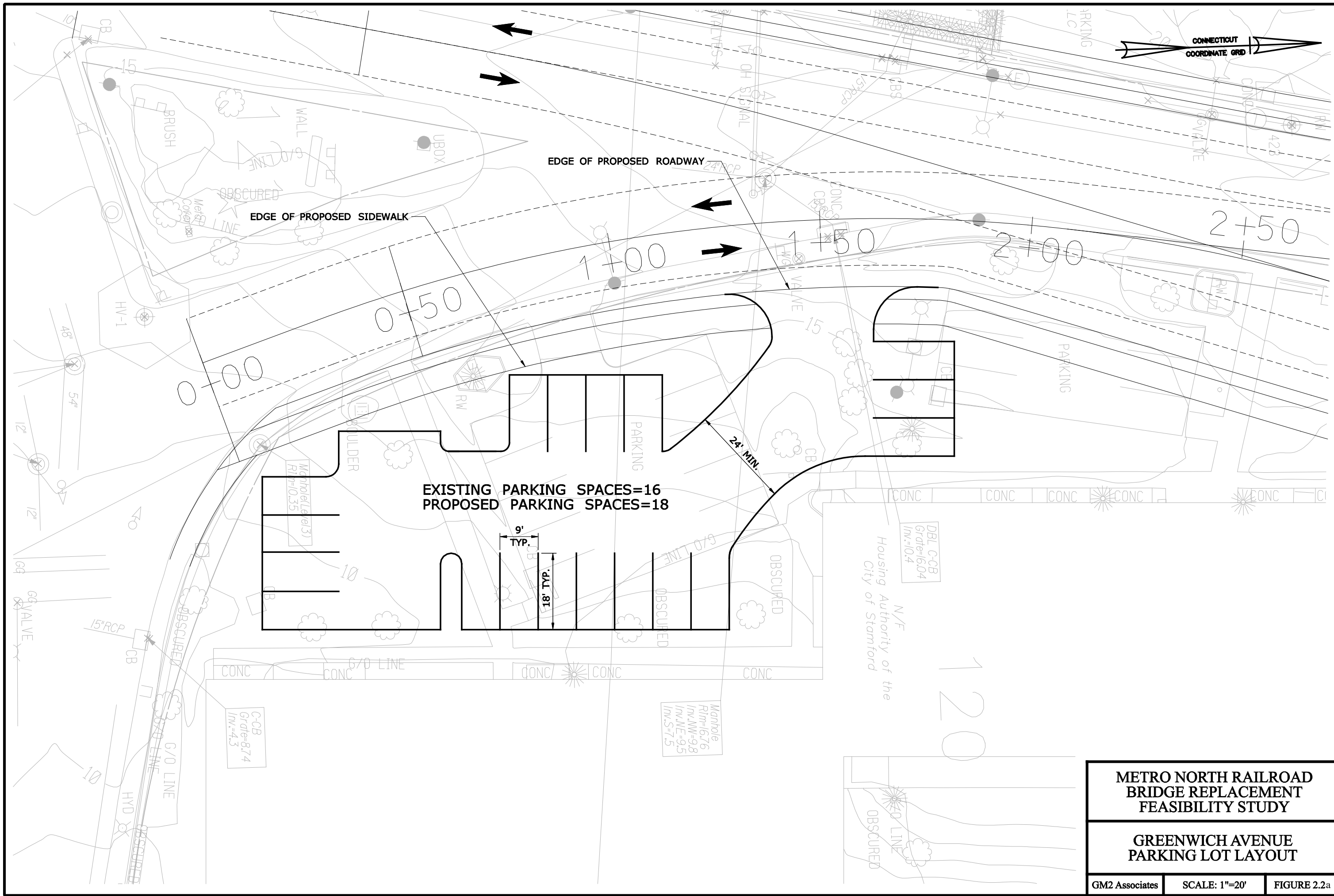

METRO NORTH RAILROAD BRIDGE REPLACEMENT FEASIBILITY STUDY		
GREENWICH AVENUE PARKING LOT LAYOUT		
GM2 Associates	SCALE: 1"=20'	FIGURE 2.2a

GREENWICH AVE. PROFILE

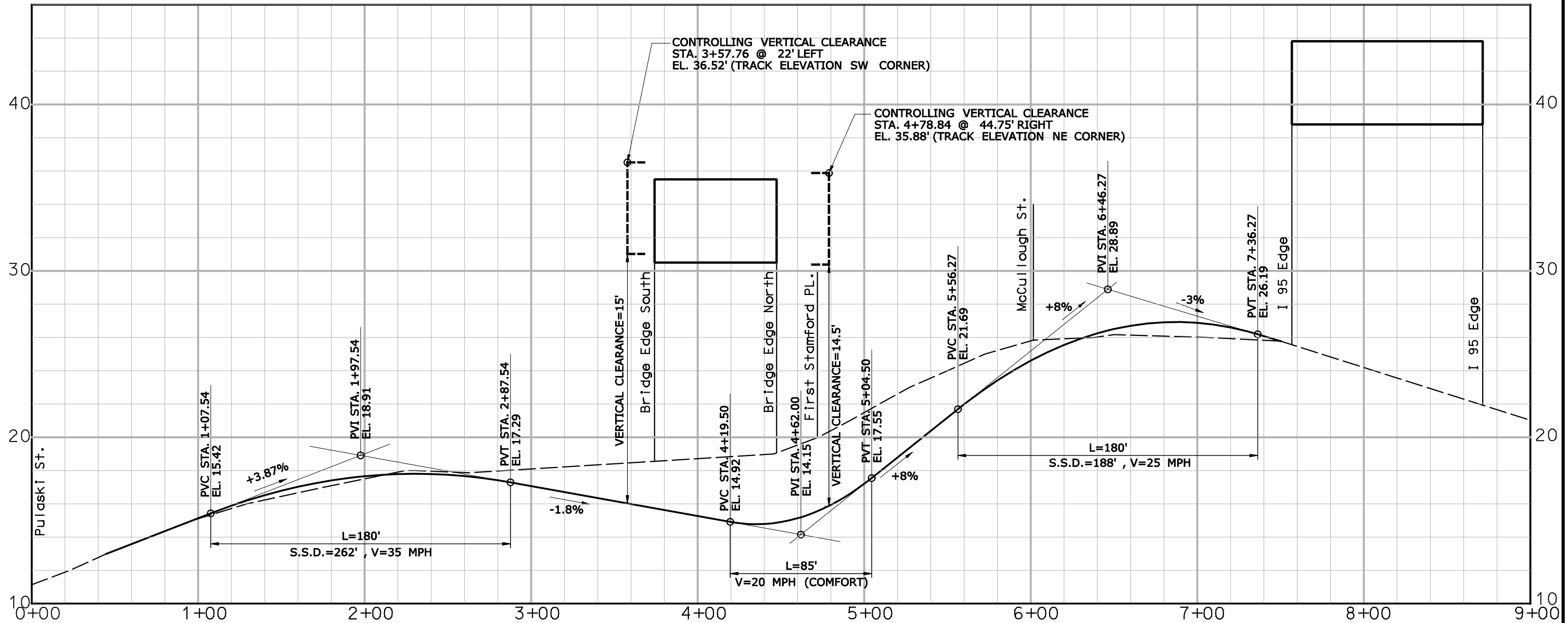

65' Span 3 Lanes NB

SCALE: Horizontal 1" = 60'
 Vertical 1" = 6'

METRO NORTH RAILROAD BRIDGE REPLACEMENT FEASIBILITY STUDY		
GREENWICH AVENUE PROFILE		
GM2 Associates	SCALE: 1"=60'	FIGURE 2.3a

FIRST STAMFORD PL. PROFILE

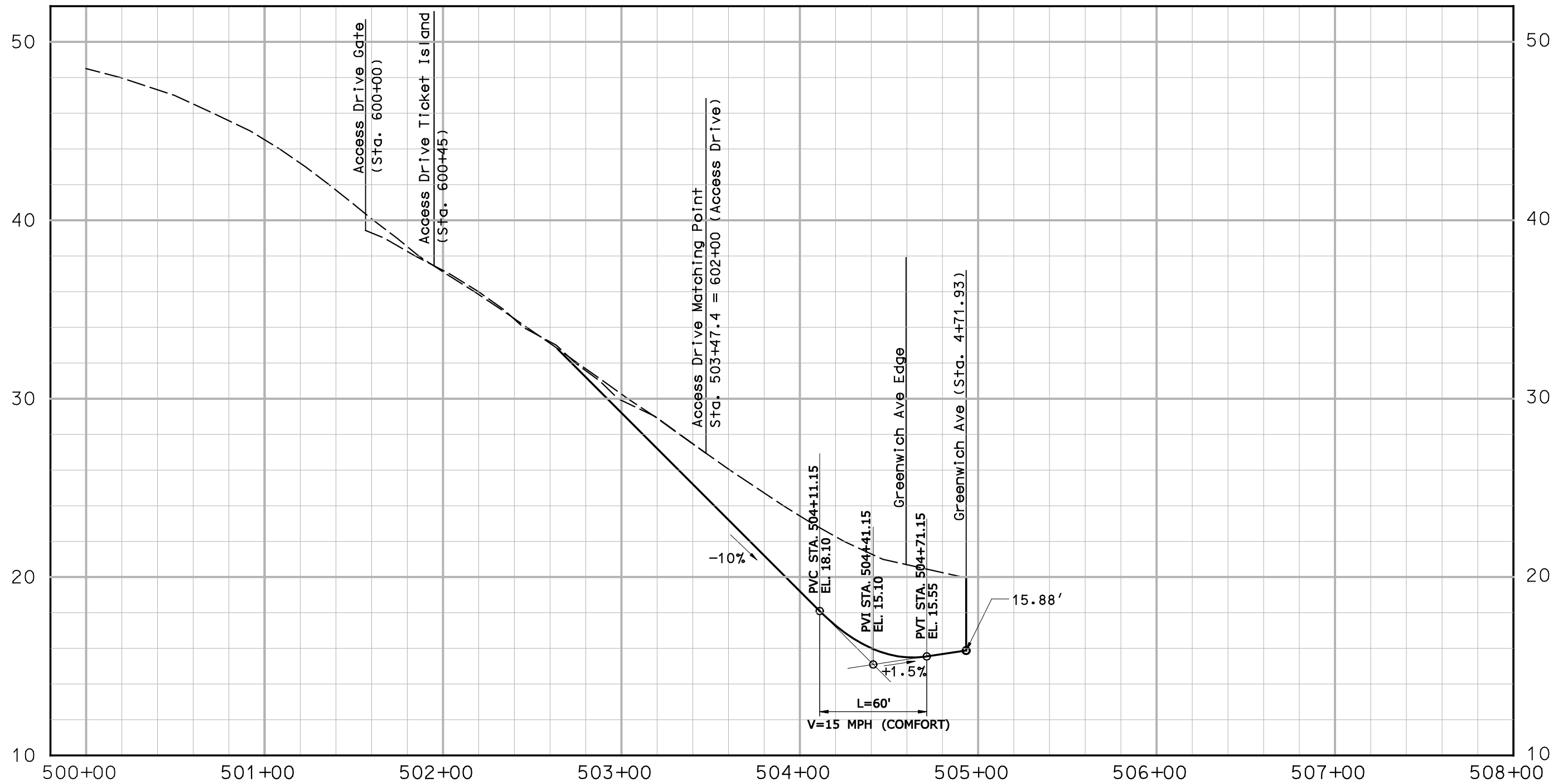

65' Span 3 Lanes NB

SCALE: Horizontal 1" = 60'
Vertical 1" = 6'

**METRO NORTH RAILROAD
BRIDGE REPLACEMENT
FEASIBILITY STUDY**

**FIRST STAMFORD PLACE
PROFILE**

McCULLOUGH ST. PROFILE

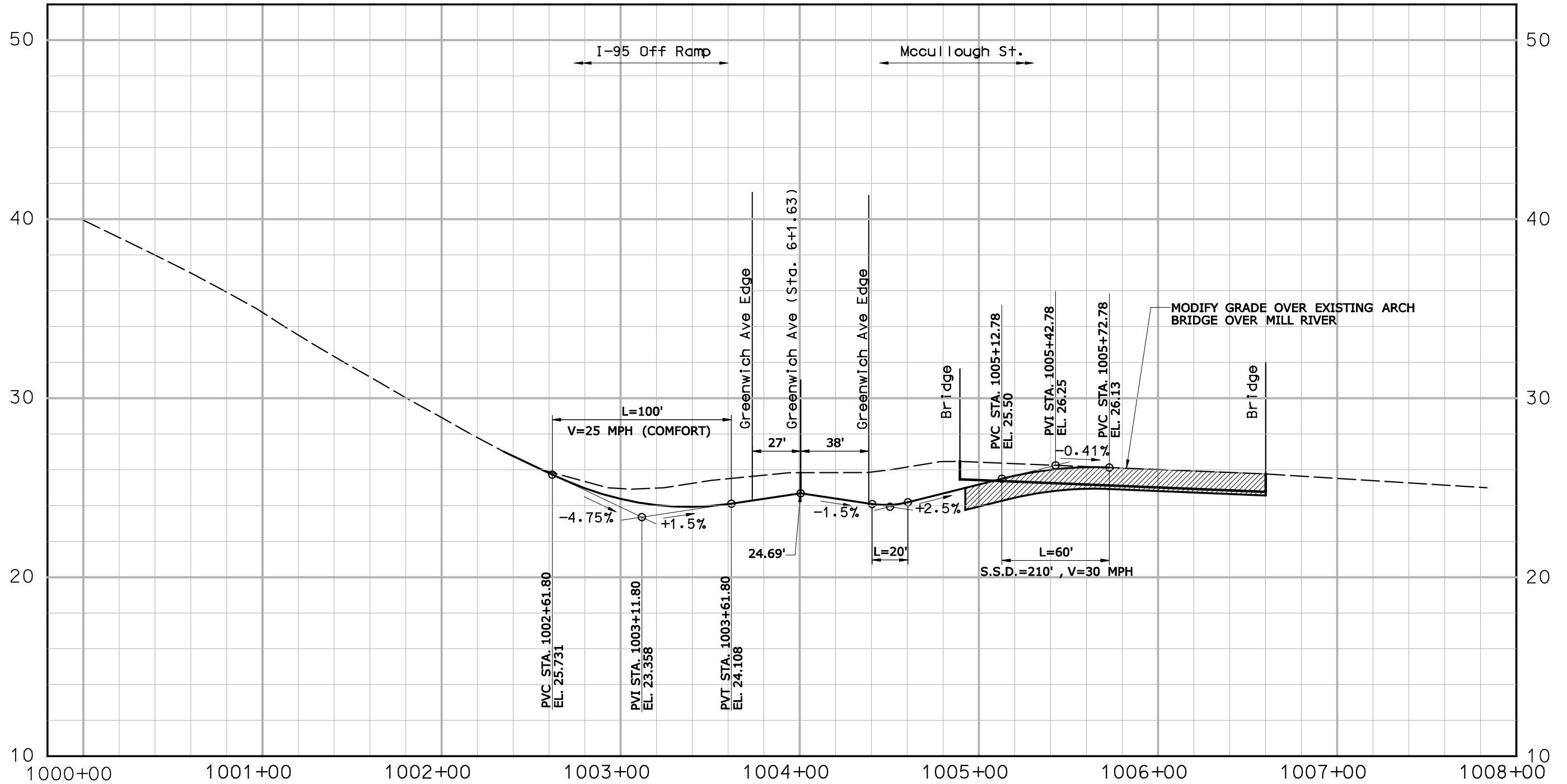

65' Span 3 Lanes NB

SCALE: Horizontal 1" = 60'
Vertical 1" = 6'

METRO NORTH RAILROAD BRIDGE REPLACEMENT FEASIBILITY STUDY		
McCULLOUGH STREET PROFILE		
GM2 Associates	SCALE: 1"=60'	FIGURE 2.3c

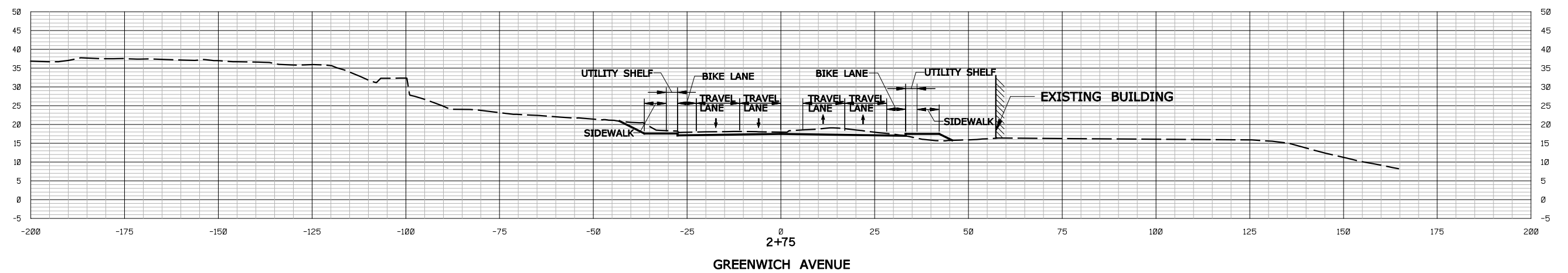
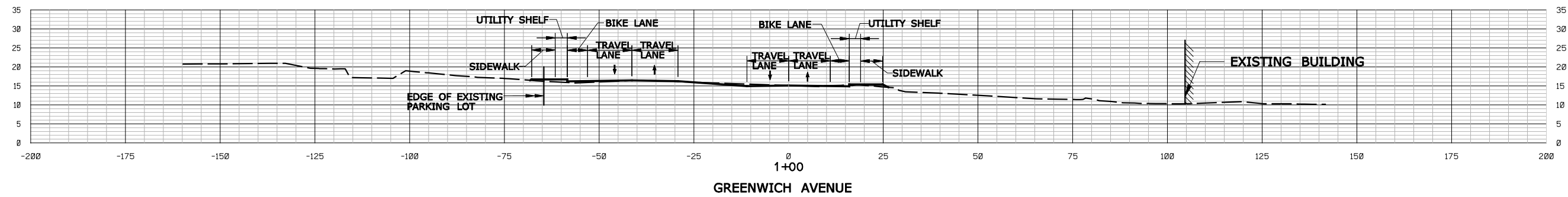

**METRO NORTH RAILROAD
BRIDGE REPLACEMENT
FEASIBILITY STUDY**

CRITICAL SECTIONS - 1

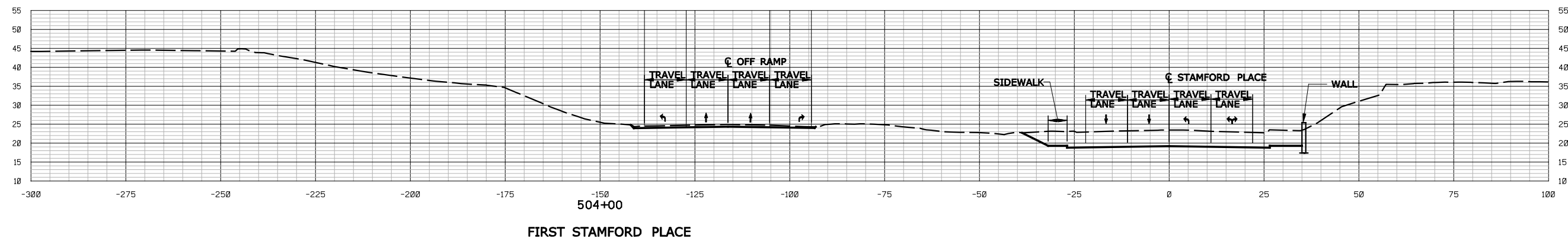

METRO NORTH RAILROAD BRIDGE REPLACEMENT FEASIBILITY STUDY		
CRITICAL SECTIONS - 2		
GM2 Associates	SCALE: 1"=30'	FIGURE 2.4b

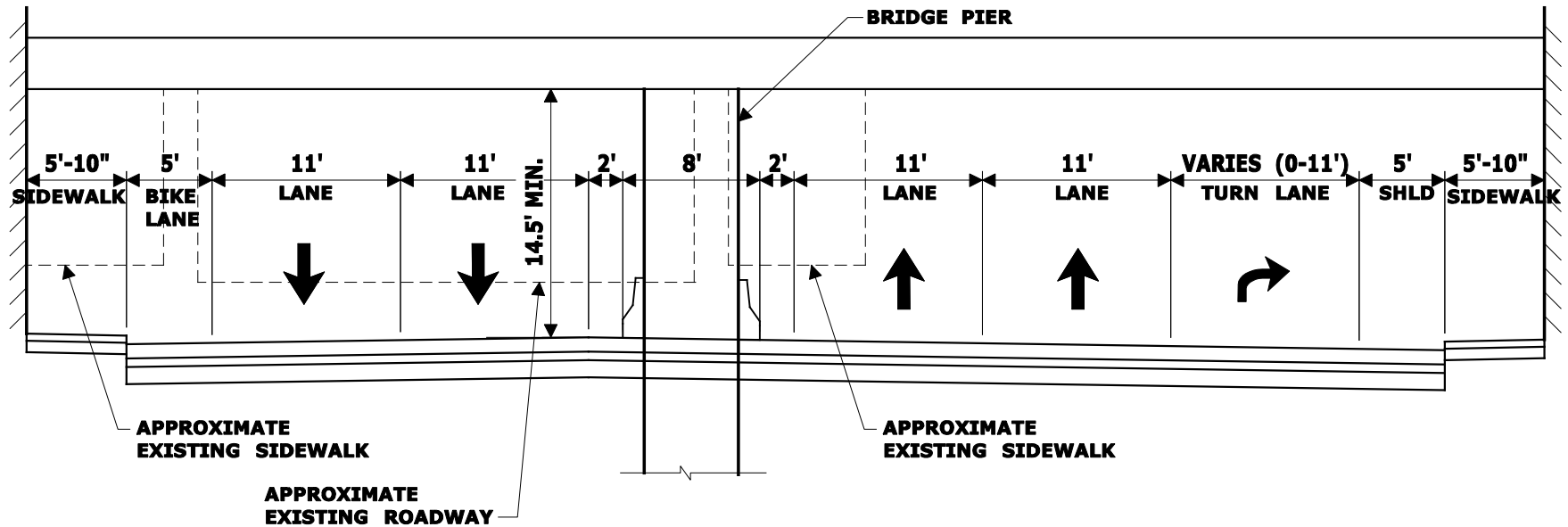

GREENWICH AVENUE LOOKING NORTHBOUND

SOUTH STAMFORD ACCESSIBILITY
& MNRR BRIDGE REPLACEMENT
FEASIBILITY STUDY

GREENWICH AVENUE
TYPICAL SECTION

URS

SCALE: 1" = 10'

FIGURE 2.5

LEGEND:

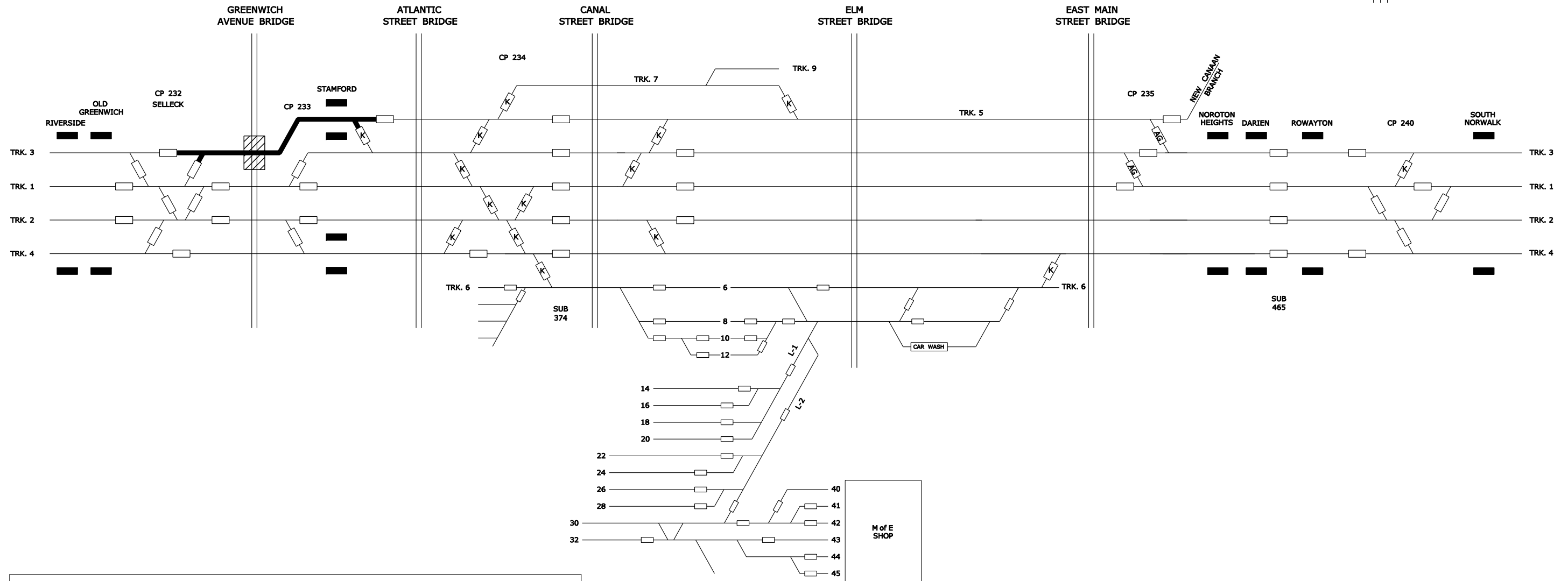
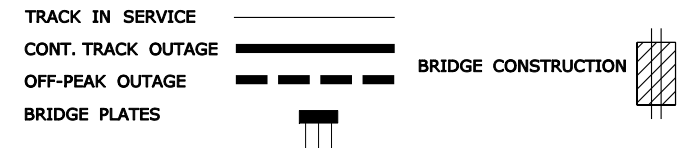

STAGE	TASK	TRACK	TRACK OUTAGE
1	1) REMOVE TRACK 3 AT GREENWICH AVE. 2) REMOVE EXISTING STEEL SUPERSTRUCTURE 3) INSTALL NEW ABUTMENTS 4) INSTALL NEW CENTER PIER 5) CUT BACK TOPS OF EXISTING ABUTMENTS 6) INSTALL NEW SUPERSTRUCTURE 7) INSTALL NEW TRACK 3 AT GREENWICH AVE.	3	CONTINUOUS TRACK OUTAGE

**SOUTH STAMFORD ACCESSIBILITY
& MNRR BRIDGE REPLACEMENT
FEASIBILITY STUDY**

**GREENWICH AVENUE
CONSTRUCTION STAGING**

STAGE 1

URS

SCALE: N.T.S.

FIGURE 3.1a

LEGEND:

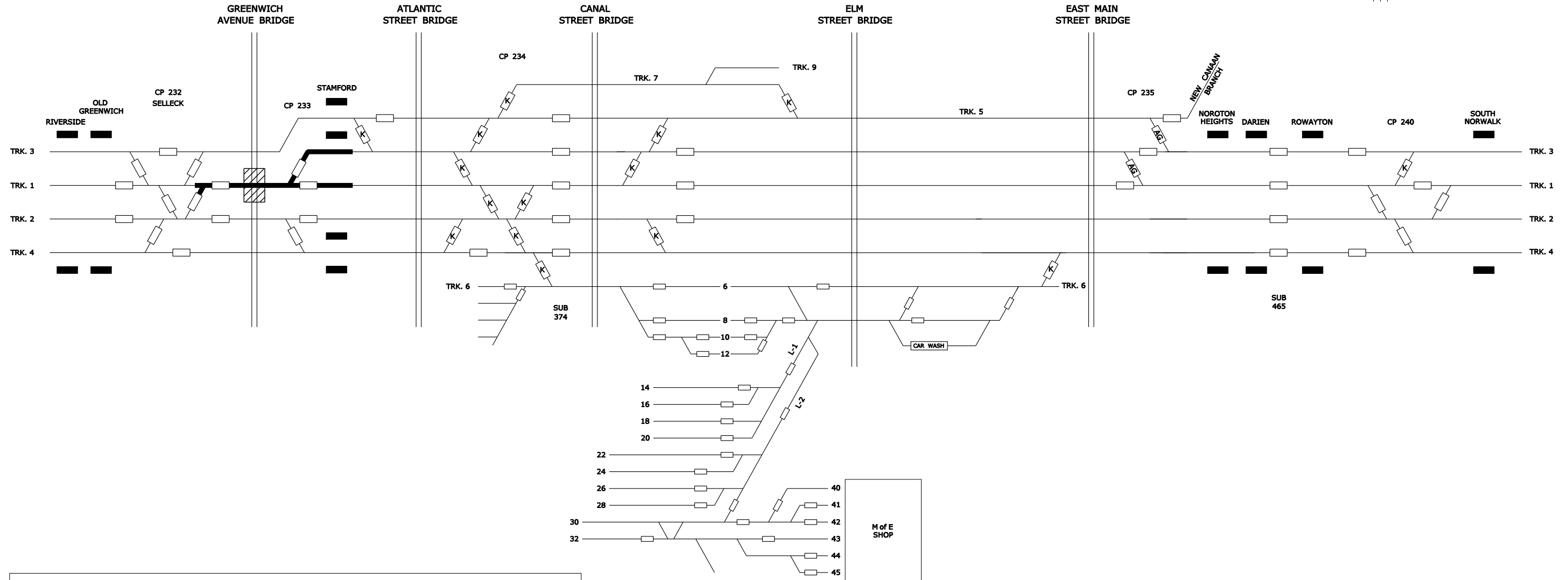
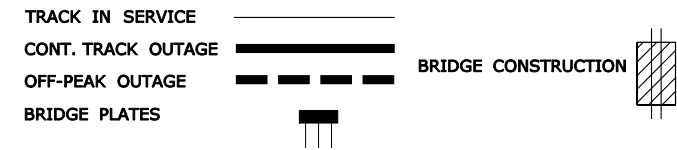

STAGE	TASK	TRACK	TRACK OUTAGE
2	1) REMOVE TRACK 1 AT GREENWICH AVE. 2) REMOVE EXISTING STEEL SUPERSTRUCTURE 3) INSTALL NEW ABUTMENTS 4) INSTALL NEW CENTER PIER 5) CUT BACK TOPS OF EXISTING ABUTMENTS 6) INSTALL NEW SUPERSTRUCTURE 7) INSTALL NEW TRACK 1 AT GREENWICH AVE.	1,3	CONTINUOUS TRACK OUTAGE

**SOUTH STAMFORD ACCESSIBILITY
& MNRR BRIDGE REPLACEMENT
FEASIBILITY STUDY**

**GREENWICH AVENUE
CONSTRUCTION STAGING**

STAGE 2

URS

SCALE: N.T.S.

FIGURE 3.1b

LEGEND:

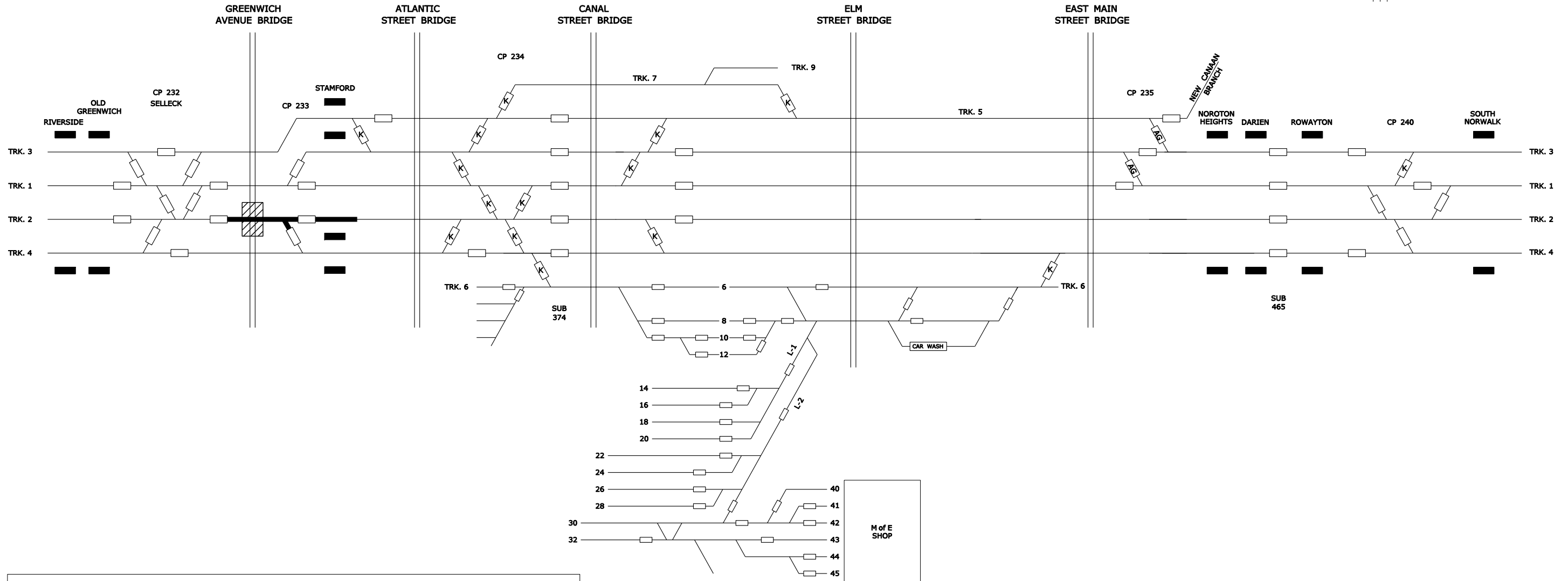
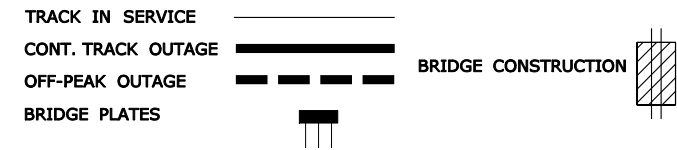

STAGE	TASK	TRACK	TRACK OUTAGE
3	1) REMOVE TRACK 2 AT GREENWICH AVE. 2) REMOVE EXISTING STEEL SUPERSTRUCTURE 3) INSTALL NEW ABUTMENTS 4) INSTALL NEW CENTER PIER 5) CUT BACK TOPS OF EXISTING ABUTMENTS 6) INSTALL NEW SUPERSTRUCTURE 7) INSTALL NEW TRACK 2 AT GREENWICH AVE.	2	CONTINUOUS TRACK OUTAGE

**SOUTH STAMFORD ACCESSIBILITY
& MNRR BRIDGE REPLACEMENT
FEASIBILITY STUDY**

**GREENWICH AVENUE
CONSTRUCTION STAGING**

STAGE 3

URS

SCALE: N.T.S.

FIGURE 3.1c

LEGEND:

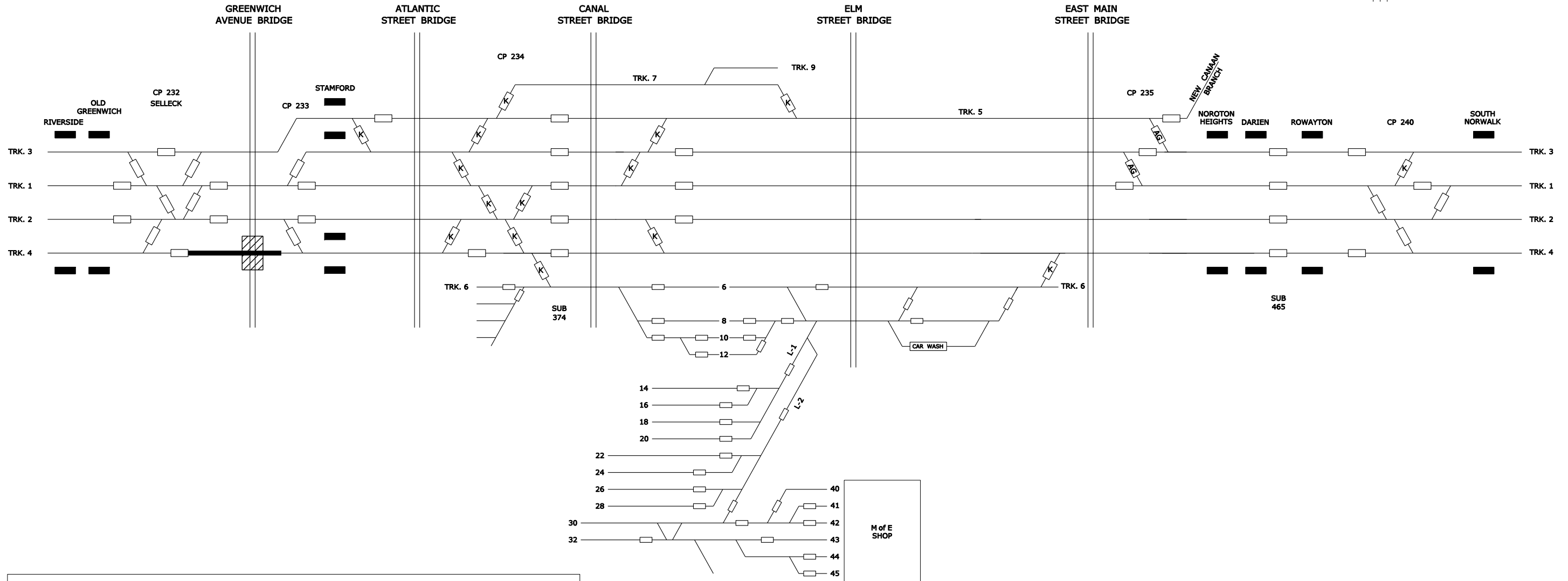
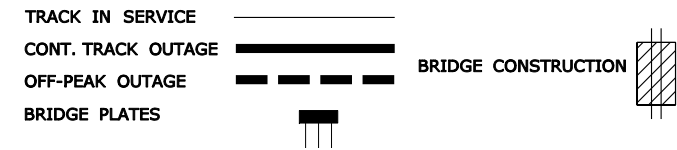

STAGE	TASK	TRACK	TRACK OUTAGE
4	1) REMOVE TRACK 4 AT GREENWICH AVE. 2) REMOVE EXISTING STEEL SUPERSTRUCTURE 3) INSTALL NEW ABUTMENTS 4) INSTALL NEW CENTER PIER 5) CUT BACK TOPS OF EXISTING ABUTMENTS 6) INSTALL NEW SUPERSTRUCTURE 7) INSTALL NEW TRACK 4 AT GREENWICH AVE.	4	CONTINUOUS TRACK OUTAGE

**SOUTH STAMFORD ACCESSIBILITY
 & MNR BRIDGE REPLACEMENT
 FEASIBILITY STUDY**

**GREENWICH AVENUE
 CONSTRUCTION STAGING**

STAGE 4

URS | SCALE: N.T.S. | FIGURE 3.1d

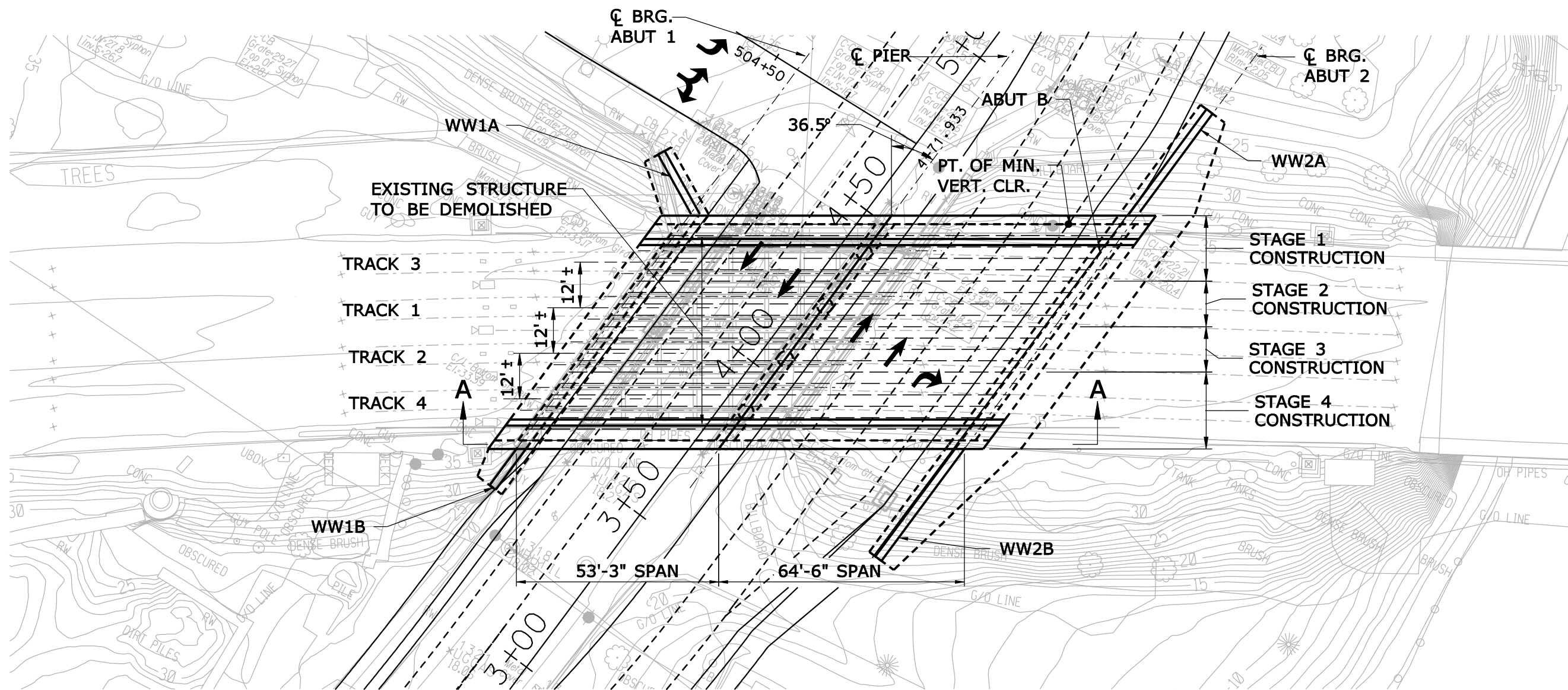

PLAN

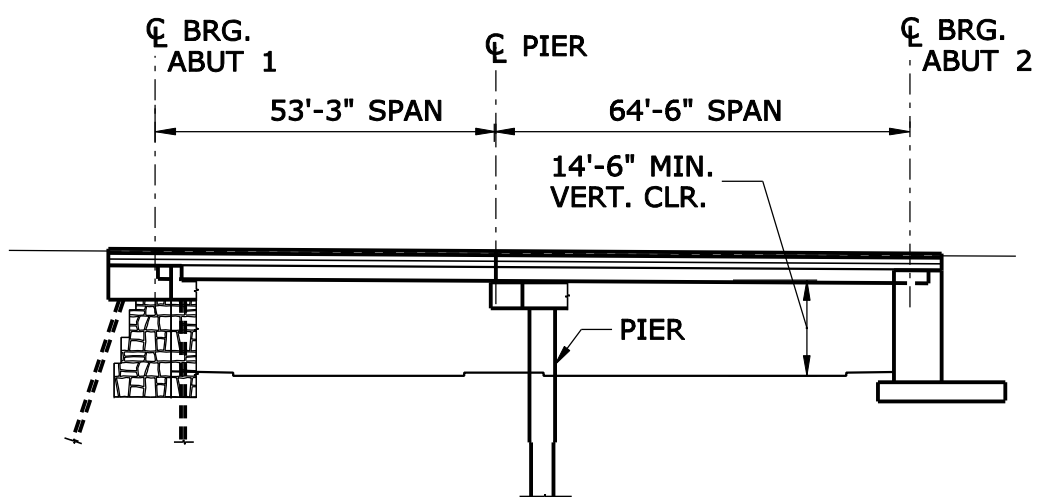

ELEVATION A-A

NOTE: ALT 1 SHOWN. ALT 2 IS SIMILAR.

METRO NORTH RAILROAD BRIDGE REPLACEMENT FEASIBILITY STUDY		
GREENWICH AVENUE PROPOSED PLAN & ELEVATION		
GM2 Associates	SCALE: 1"= 30'	FIGURE 4.1

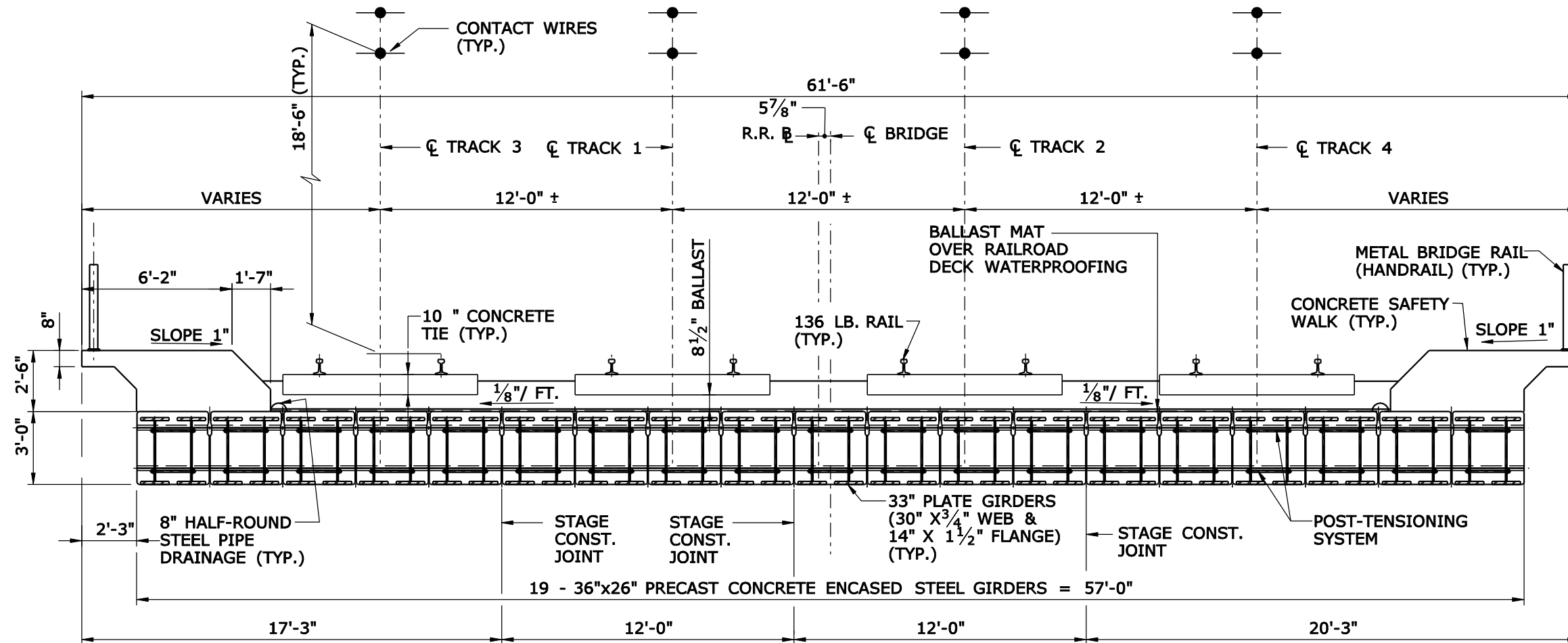

ALT 1: TYPICAL SECTION

SCALE: $\frac{3}{16}$ " = 1'-0"

METRO NORTH RAILROAD BRIDGE REPLACEMENT FEASIBILITY STUDY		
GREENWICH AVENUE ALT 1: TYPICAL SECTION		
GM2 Associates	SCALE: $\frac{3}{16}$ " = 1'-0"	FIGURE 4.2

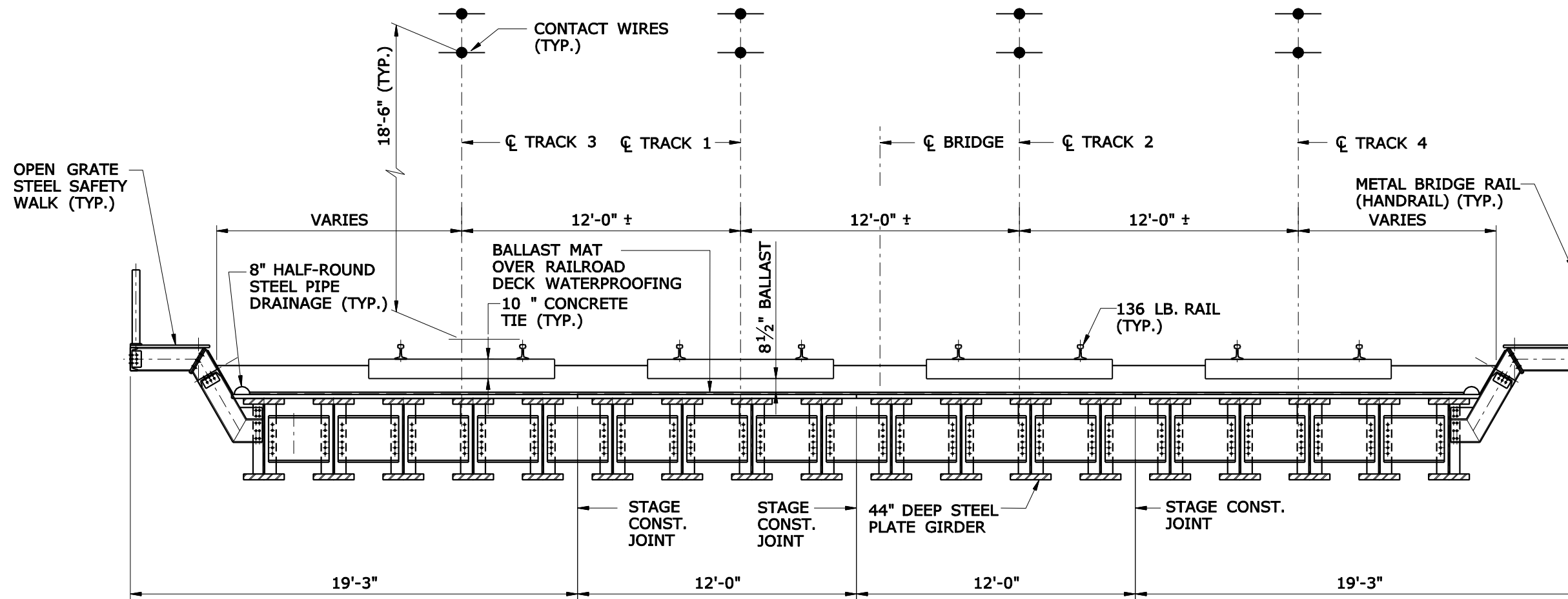

ALT 2: TYPICAL SECTION

SCALE: 3/16" = 1'-0"

METRO NORTH RAILROAD
BRIDGE REPLACEMENT
FEASIBILITY STUDY

GREENWICH AVENUE
ALT 2: TYPICAL SECTION

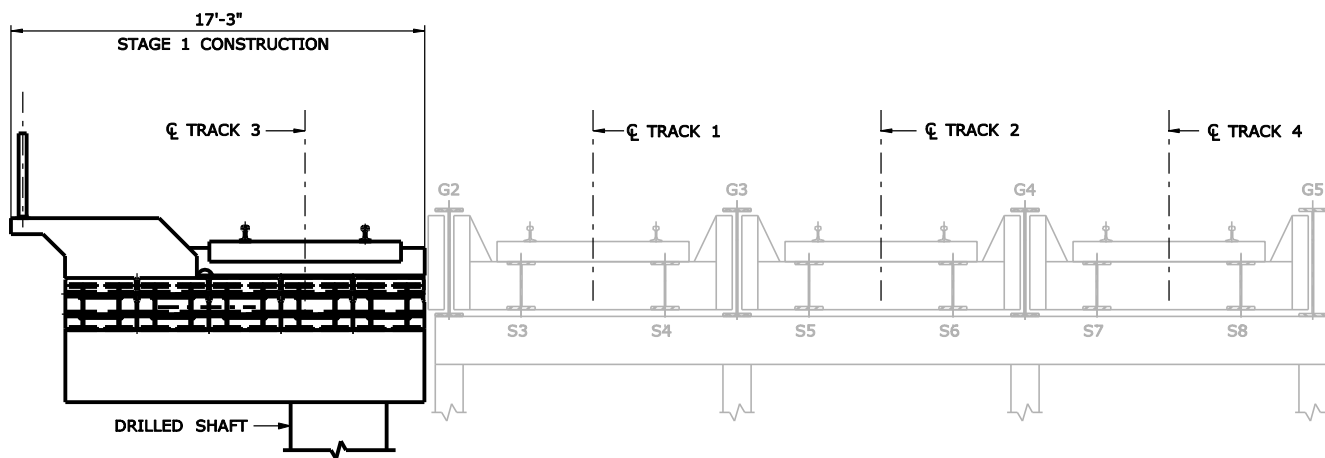

STAGE 1

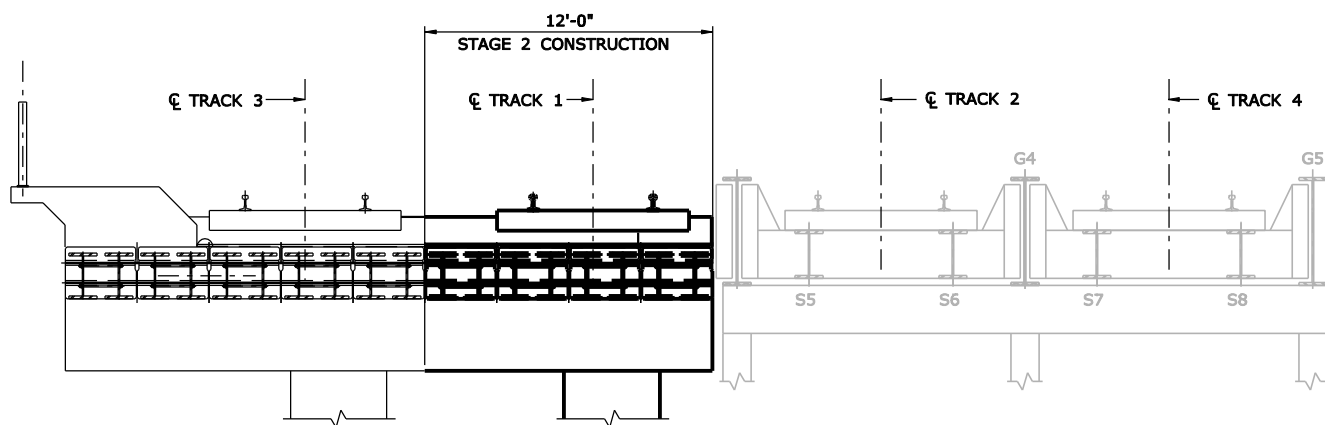

STAGE 2

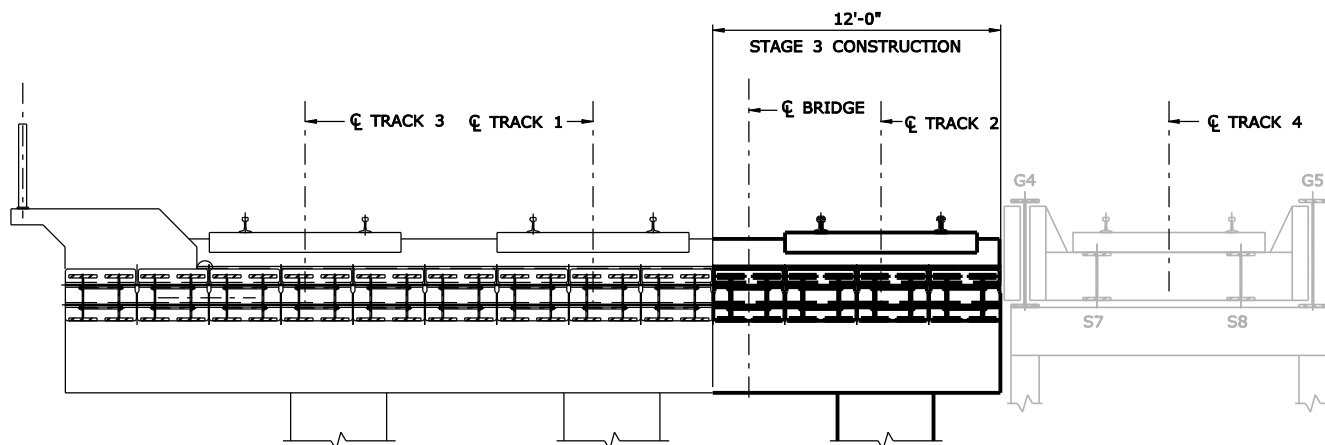

STAGE 3

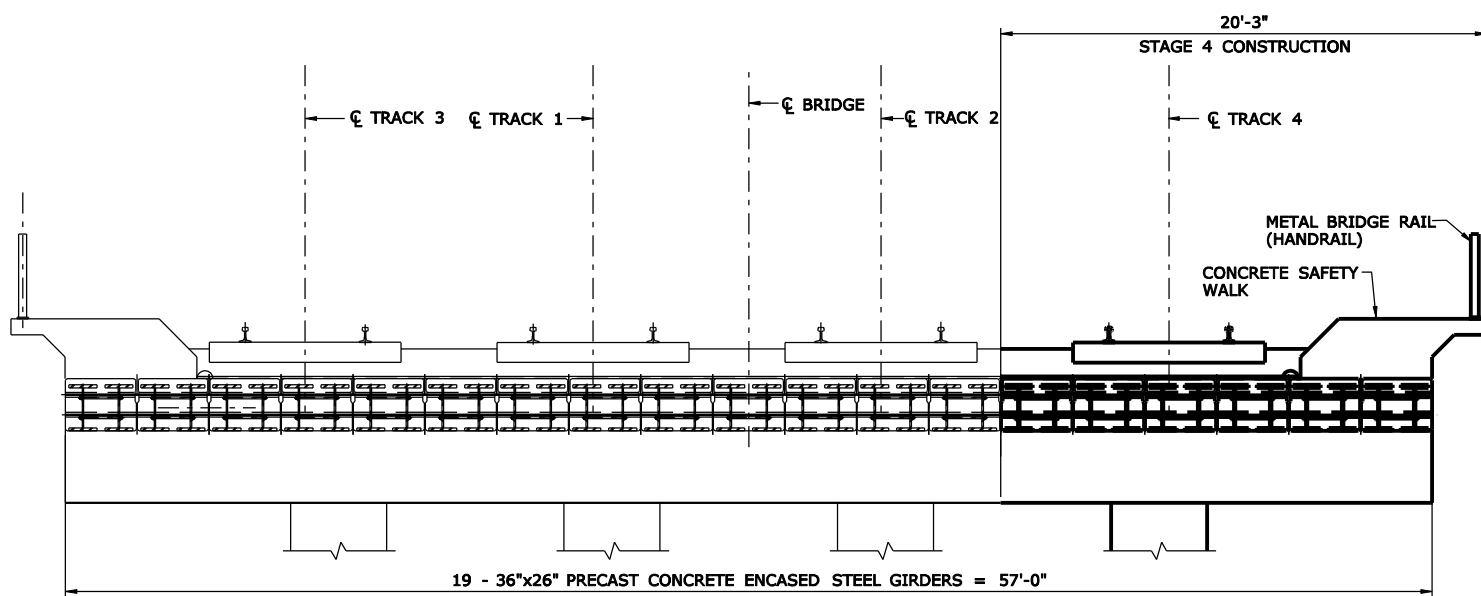

STAGE 4

METRO NORTH RAILROAD
BRIDGE REPLACEMENT
FEASIBILITY STUDY

GREENWICH AVENUE
STAGE CONSTRUCTION

NOTE: STAGE CONSTRUCTION SHOWN FOR ALT 1. ALT 2 IS SIMILAR.

GM2 Associates

SCALE: 1/8"= 1'

FIGURE 4.4

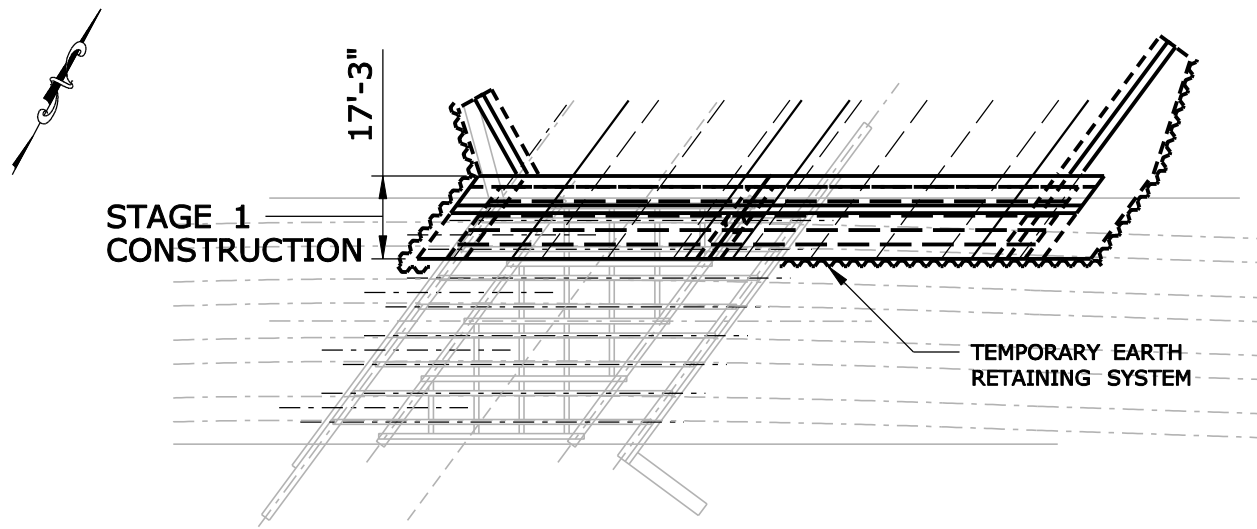

STAGE 1

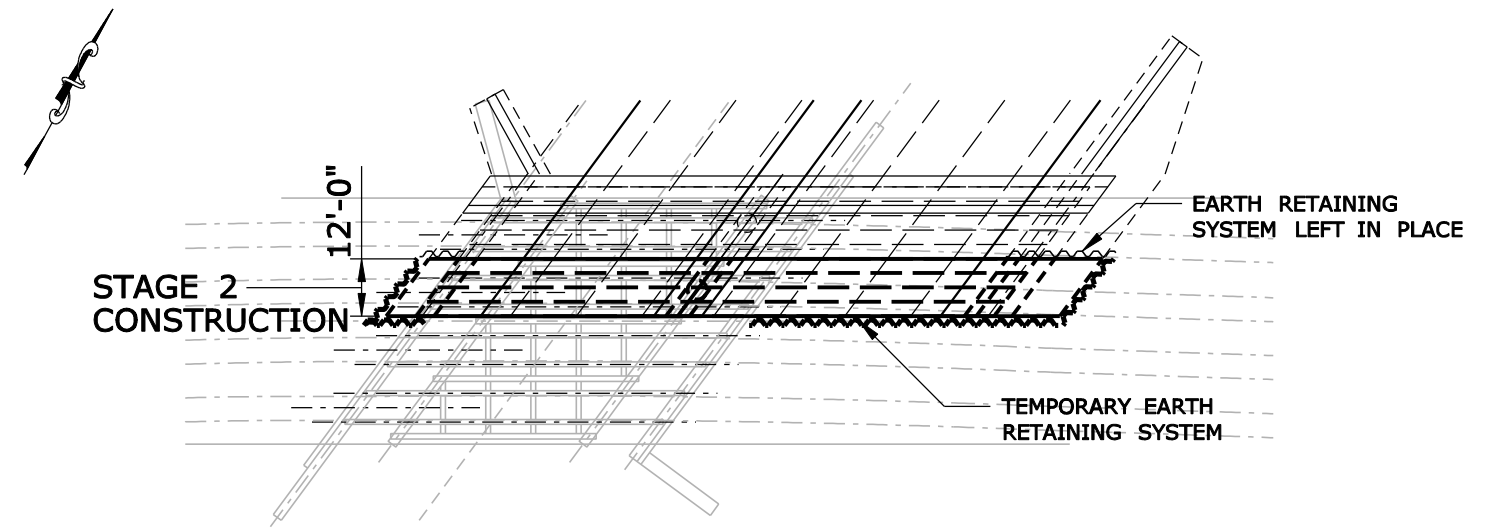

STAGE 2

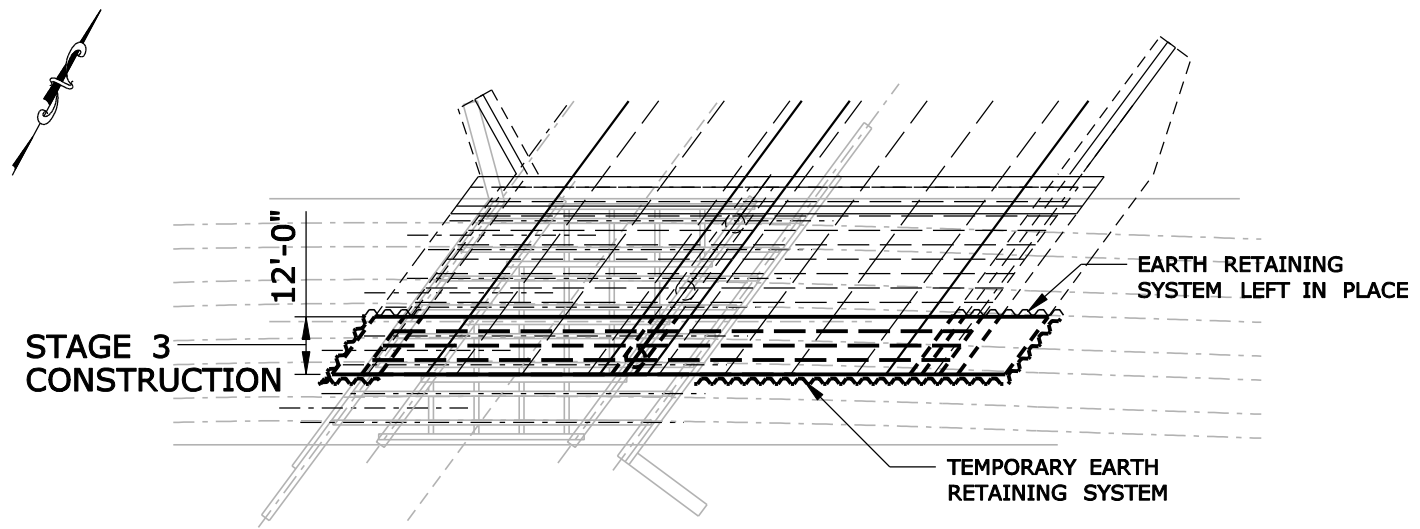

STAGE 3

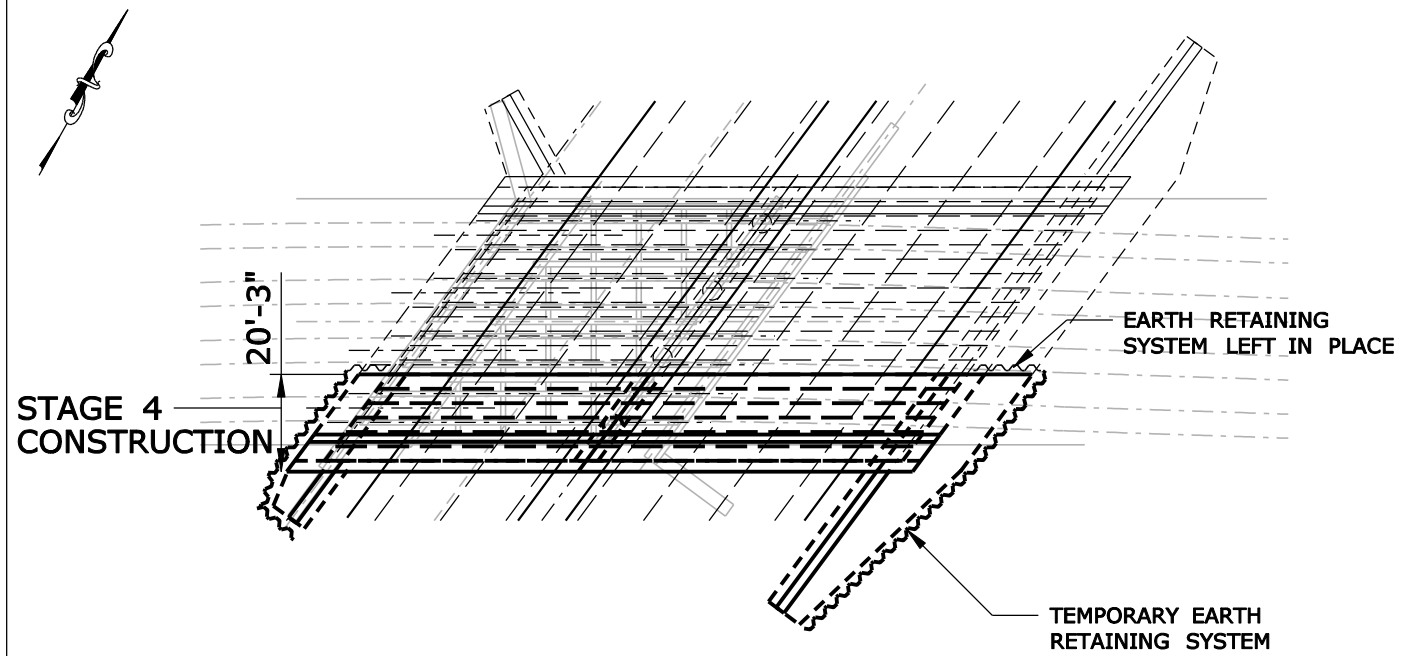

STAGE 4

NOTE: 1. ALT 1 SHOWN. ALT 2 IS ISMILAR.
2. SEE FIGURE 4.4 FOR SECTIONS.

**METRO NORTH RAILROAD
BRIDGE REPLACEMENT
FEASIBILITY STUDY**

**GREENWICH AVENUE
STAGE CONSTRUCTION PLAN**

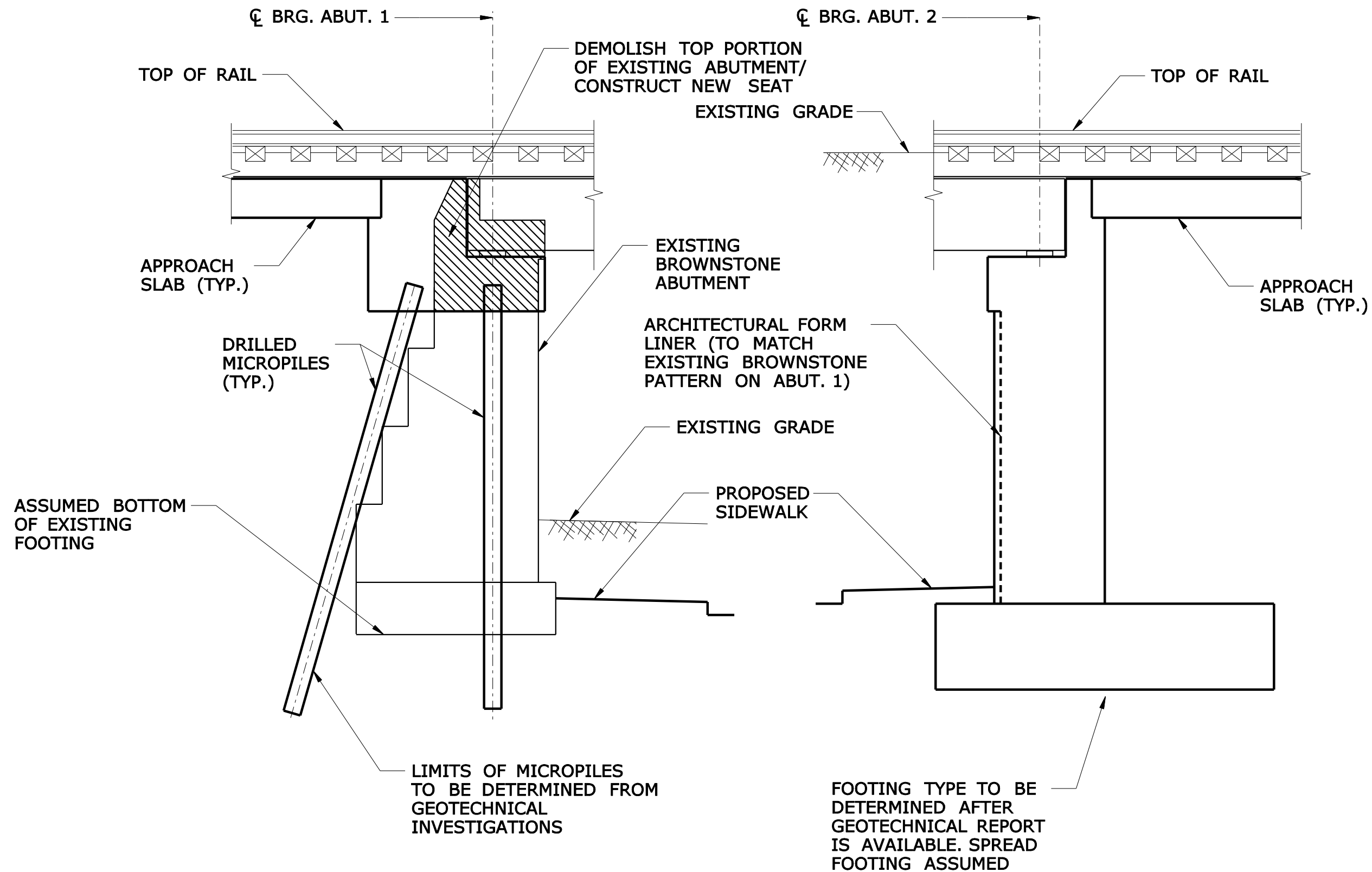

ABUTMENT 1 (WEST)
SCALE: 1/4" = 1'-0"

ABUTMENT 2 (EAST)
SCALE: 1/4" = 1'-0"

METRO NORTH RAILROAD BRIDGE REPLACEMENT FEASIBILITY STUDY		
GREENWICH AVENUE ABUTMENTS		
GM2 Associates	SCALE: 1/4" = 1'	FIGURE 4.6

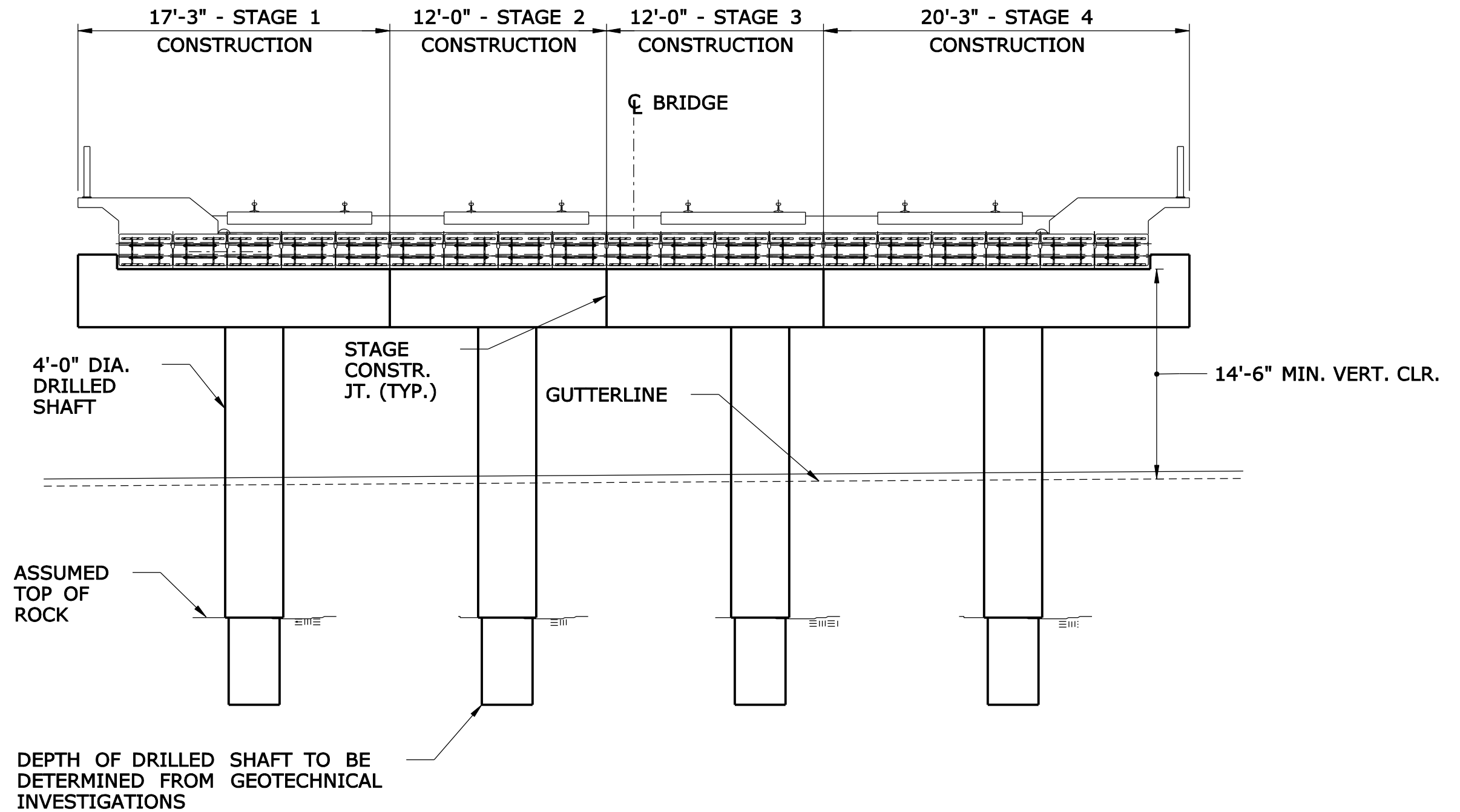

PIER ELEVATION (LOOKING EAST TOWARDS NEW HAVEN)

SCALE: 1/8" = 1'-0"

NOTE: ALT 1 SHOWN. ALT 2 IS SIMILAR.

METRO NORTH RAILROAD BRIDGE REPLACEMENT FEASIBILITY STUDY		
GREENWICH AVENUE PIER		
GM2 Associates	SCALE: 1/8"= 1'	FIGURE 4.7

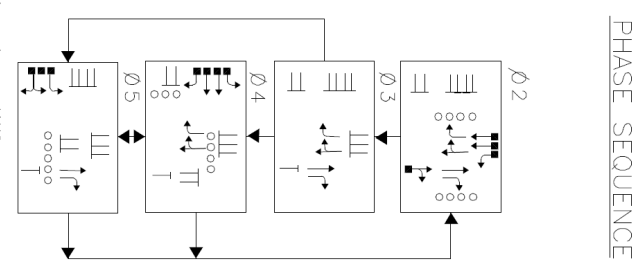
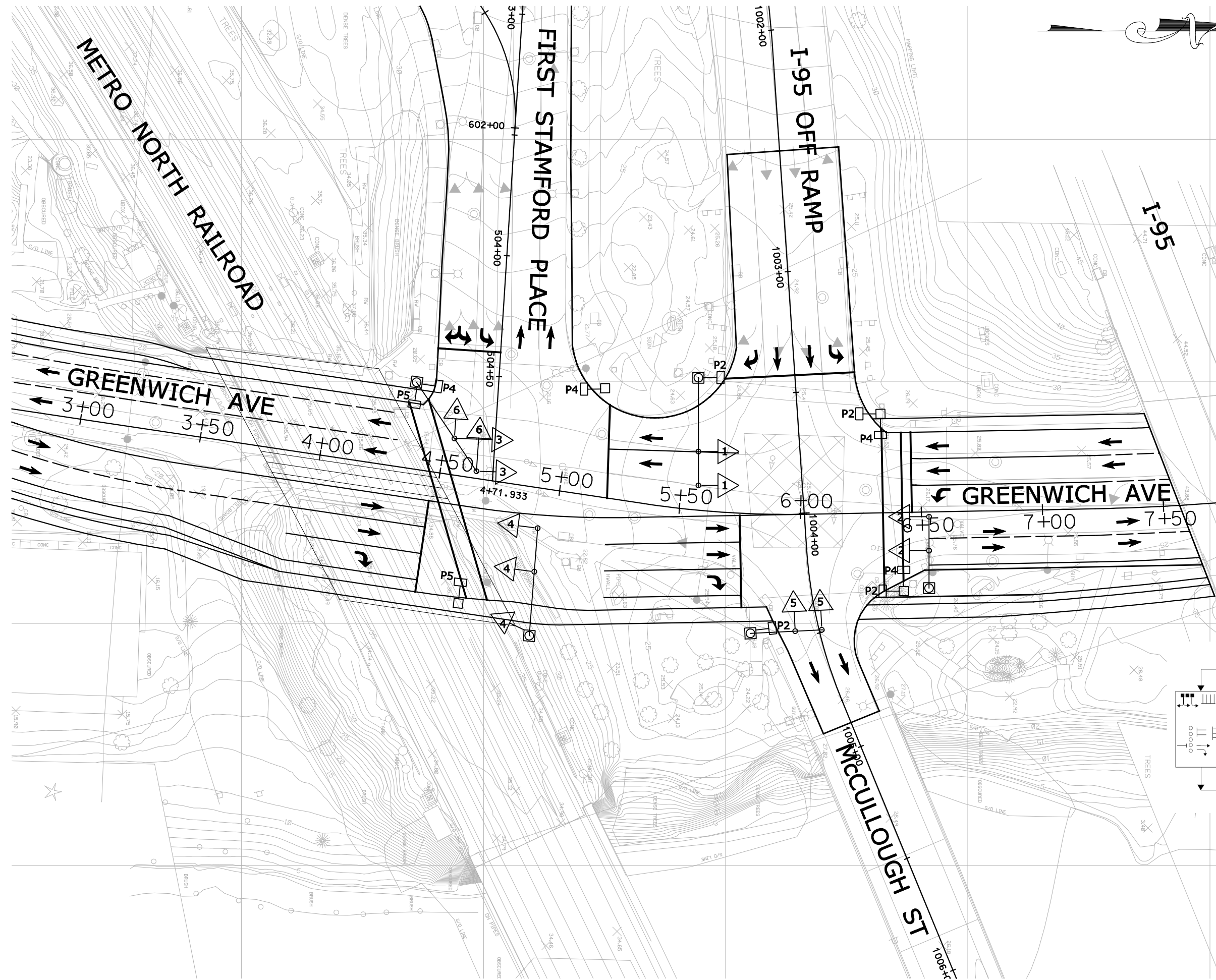
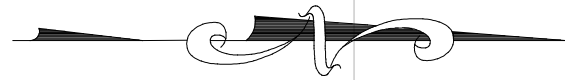

METRO NORTH RAILROAD BRIDGE REPLACEMENT FEASIBILITY STUDY		
GREENWICH AVENUE SIGNAL LAYOUT PLAN		
GM2 Associates	SCALE: 1"=40'	FIGURE 5.1

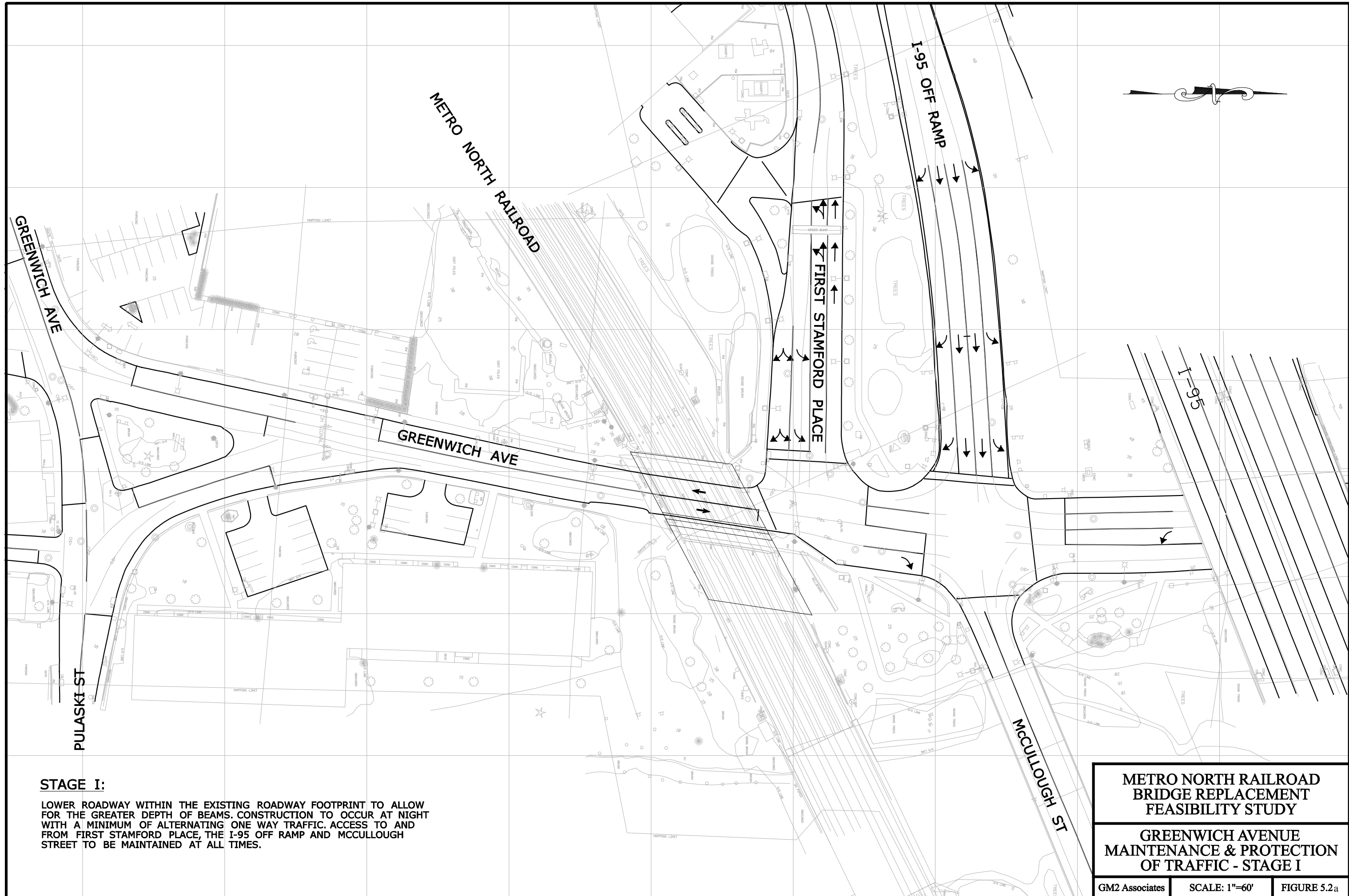

STAGE I:

LOWER ROADWAY WITHIN THE EXISTING ROADWAY FOOTPRINT TO ALLOW FOR THE GREATER DEPTH OF BEAMS. CONSTRUCTION TO OCCUR AT NIGHT WITH A MINIMUM OF ALTERNATING ONE WAY TRAFFIC. ACCESS TO AND FROM FIRST STAMFORD PLACE, THE I-95 OFF RAMP AND MCCULLOUGH STREET TO BE MAINTAINED AT ALL TIMES.

METRO NORTH RAILROAD BRIDGE REPLACEMENT FEASIBILITY STUDY		
GREENWICH AVENUE MAINTENANCE & PROTECTION OF TRAFFIC - STAGE I		
GM2 Associates	SCALE: 1"=60'	FIGURE 5.2a

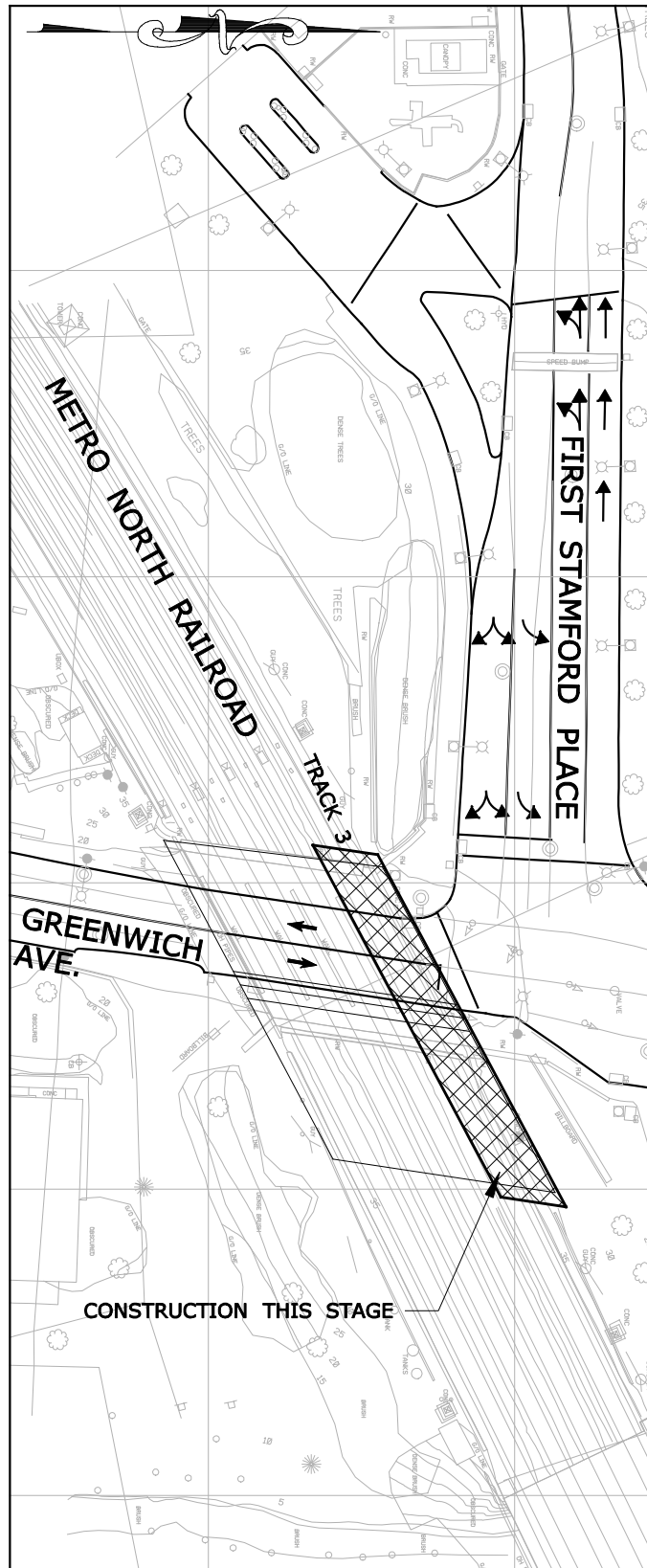

STAGE II-A:
CONSTRUCT TRACK 3.

STAGE II-A, B, C, D:

CONSTRUCT BRIDGE. MAINTAIN TWO-WAY TRAFFIC ON THE LOWERED ROADWAY. CLOSE ROAD AT NIGHT FOR THE CONSTRUCTION OF THE DRILLED SHAFTS AND ERECTION OF BEAMS. OTHERWISE, MAINTAIN ONE LANE OF TRAFFIC IN EACH DIRECTION AT ALL TIMES. ACCESS TO AND FROM FIRST STAMFORD PLACE, THE I-95 OFF RAMP AND MCCULLOUGH STREET TO BE MAINTAINED AT ALL TIMES.

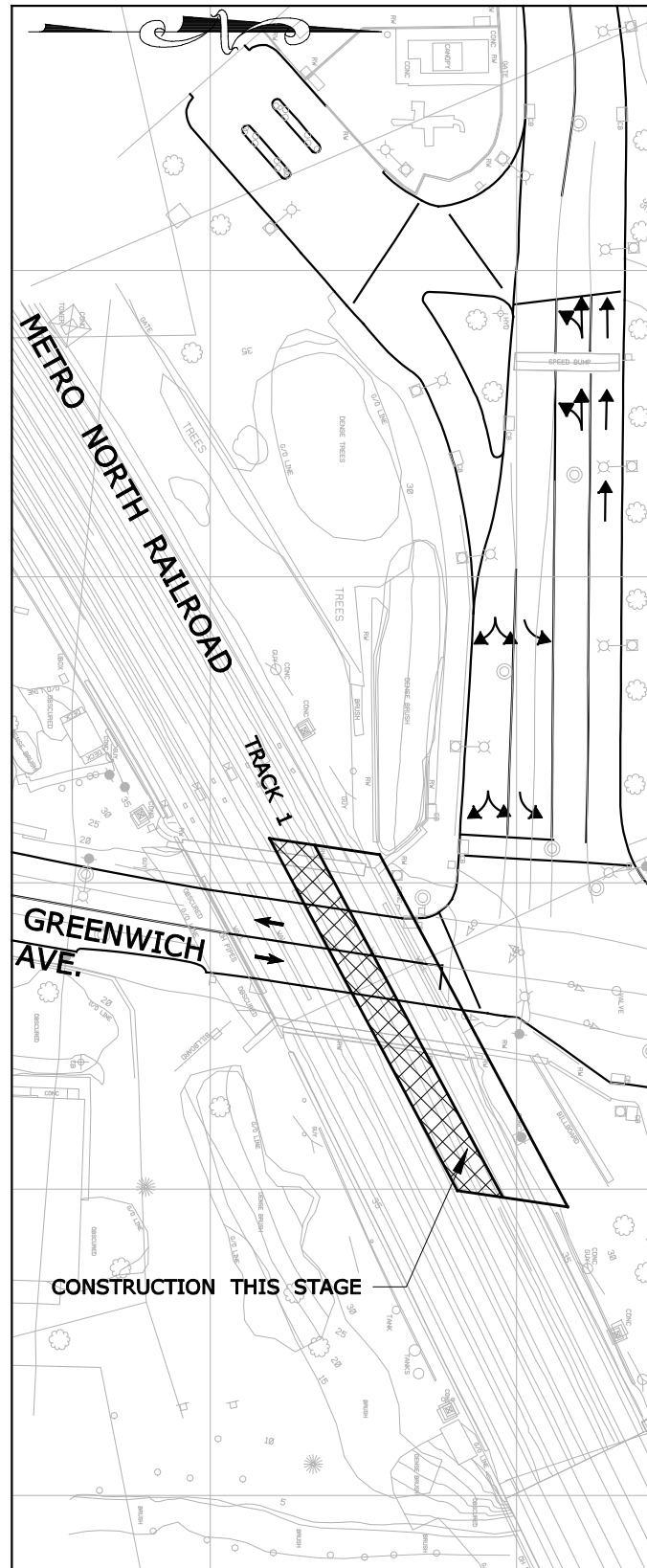

STAGE II-B:
CONSTRUCT TRACK 1.

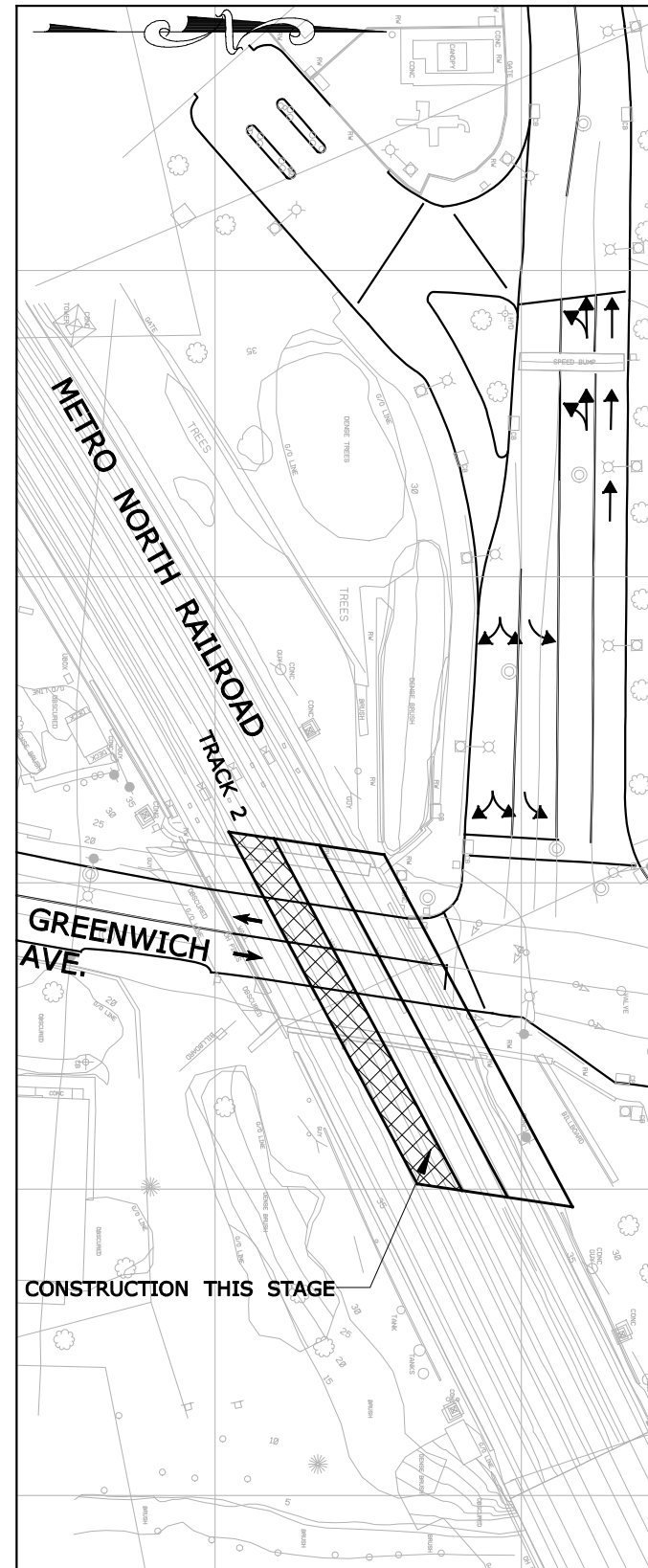

STAGE II-C:
CONSTRUCT TRACK 2.

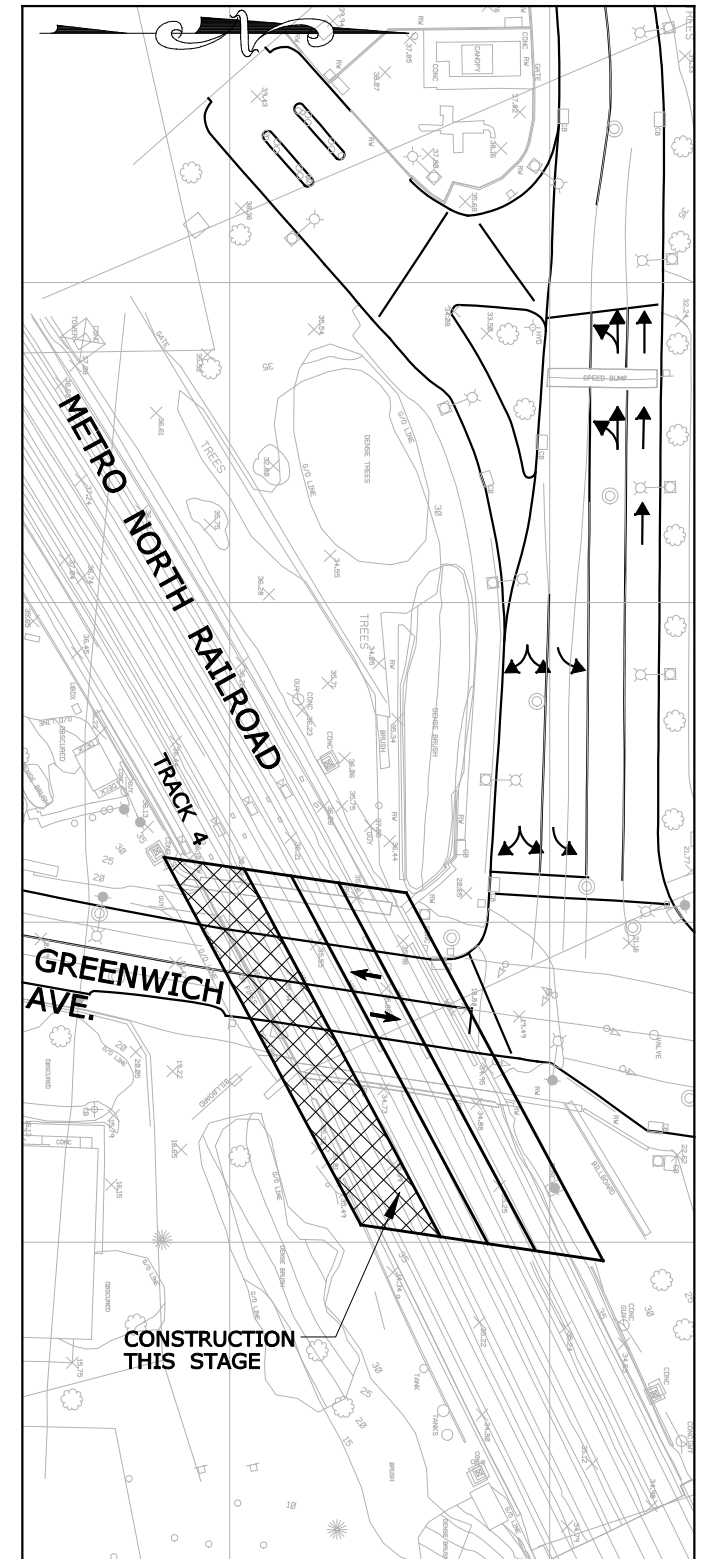

STAGE II-D:
CONSTRUCT TRACK 4.

METRO NORTH RAILROAD BRIDGE REPLACEMENT FEASIBILITY STUDY		
GREENWICH AVENUE MAINTENANCE & PROTECTION OF TRAFFIC - STAGE II		
GM2 Associates	SCALE: 1"=60'	FIGURE 5.2b

V:\135-301-Stamford_MNRB\GM2\FEASIBILITY STUDY FINAL SUBMISSION\DRG.Greenwich Ave MPT_Stage 3_REV. 02-25-11.dgn
2/25/2011

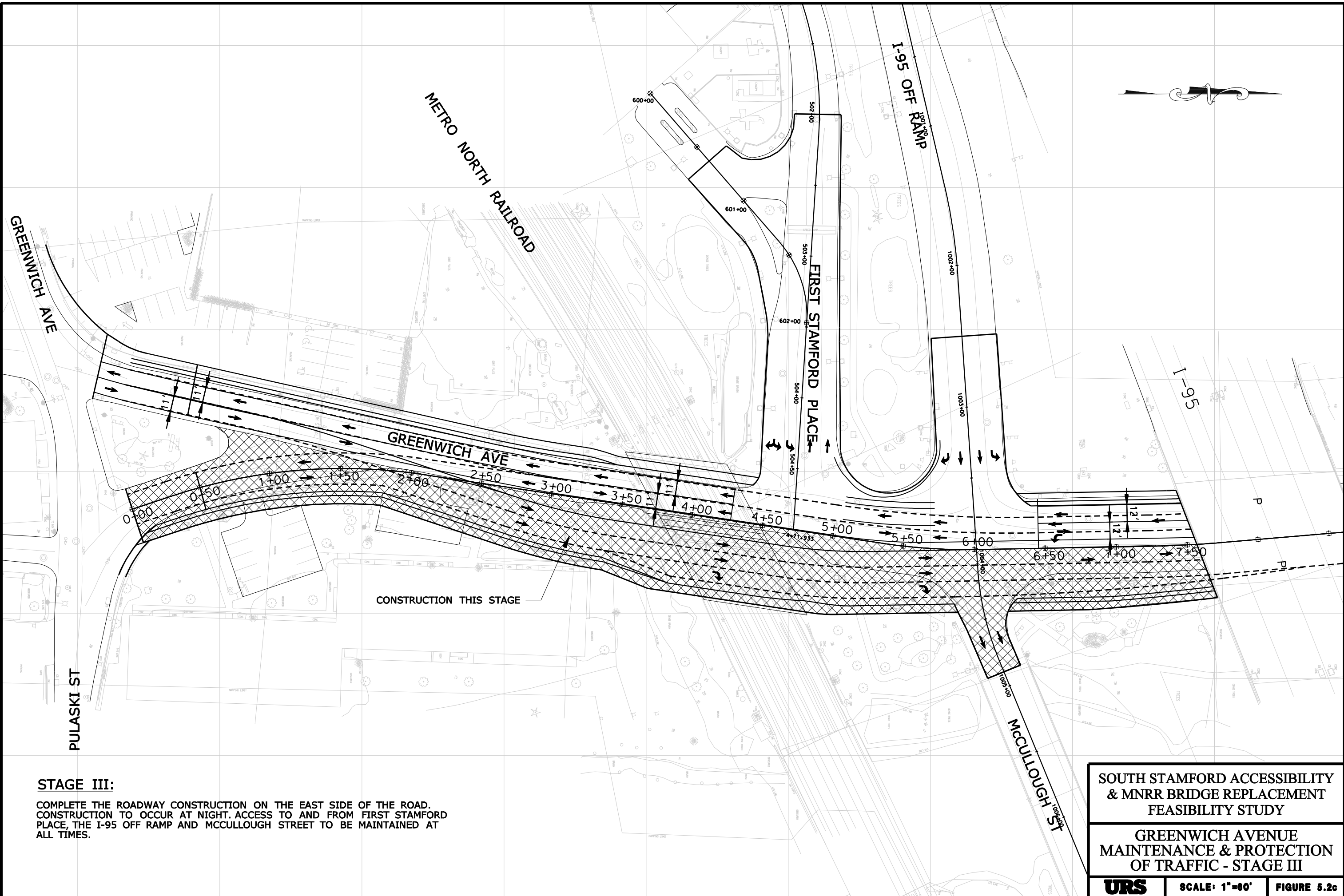

STAGE III:

COMPLETE THE ROADWAY CONSTRUCTION ON THE EAST SIDE OF THE ROAD. CONSTRUCTION TO OCCUR AT NIGHT. ACCESS TO AND FROM FIRST STAMFORD PLACE, THE I-95 OFF RAMP AND MCCULLOUGH STREET TO BE MAINTAINED AT ALL TIMES.

SOUTH STAMFORD ACCESSIBILITY & MNRR BRIDGE REPLACEMENT FEASIBILITY STUDY		
GREENWICH AVENUE MAINTENANCE & PROTECTION OF TRAFFIC - STAGE III		
URS	SCALE: 1"=60'	FIGURE 5.2c

V:\135-301-Stamford_MNRB\GM2\FEASIBILITY STUDY FINAL SUBMISSION\DRG.Greenwich Ave MPT-Stage 4-REV. 02-28-11.dgn
2/25/2011

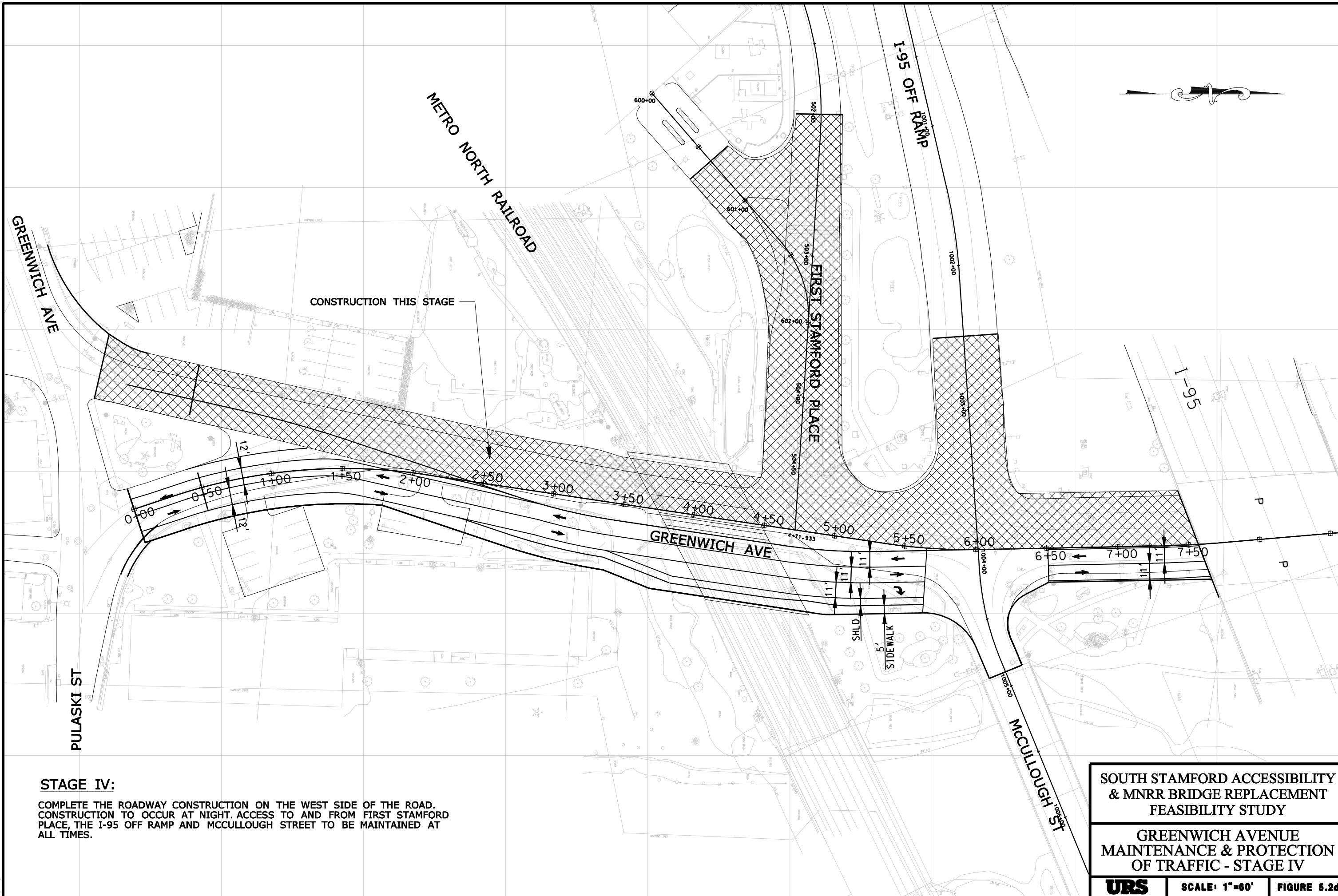

STAGE IV:

COMPLETE THE ROADWAY CONSTRUCTION ON THE WEST SIDE OF THE ROAD. CONSTRUCTION TO OCCUR AT NIGHT. ACCESS TO AND FROM FIRST STAMFORD PLACE, THE I-95 OFF RAMP AND MCCULLOUGH STREET TO BE MAINTAINED AT ALL TIMES.

SOUTH STAMFORD ACCESSIBILITY & MNRR BRIDGE REPLACEMENT FEASIBILITY STUDY		
GREENWICH AVENUE MAINTENANCE & PROTECTION OF TRAFFIC - STAGE IV		
URS	SCALE: 1"=60'	FIGURE 5.2d

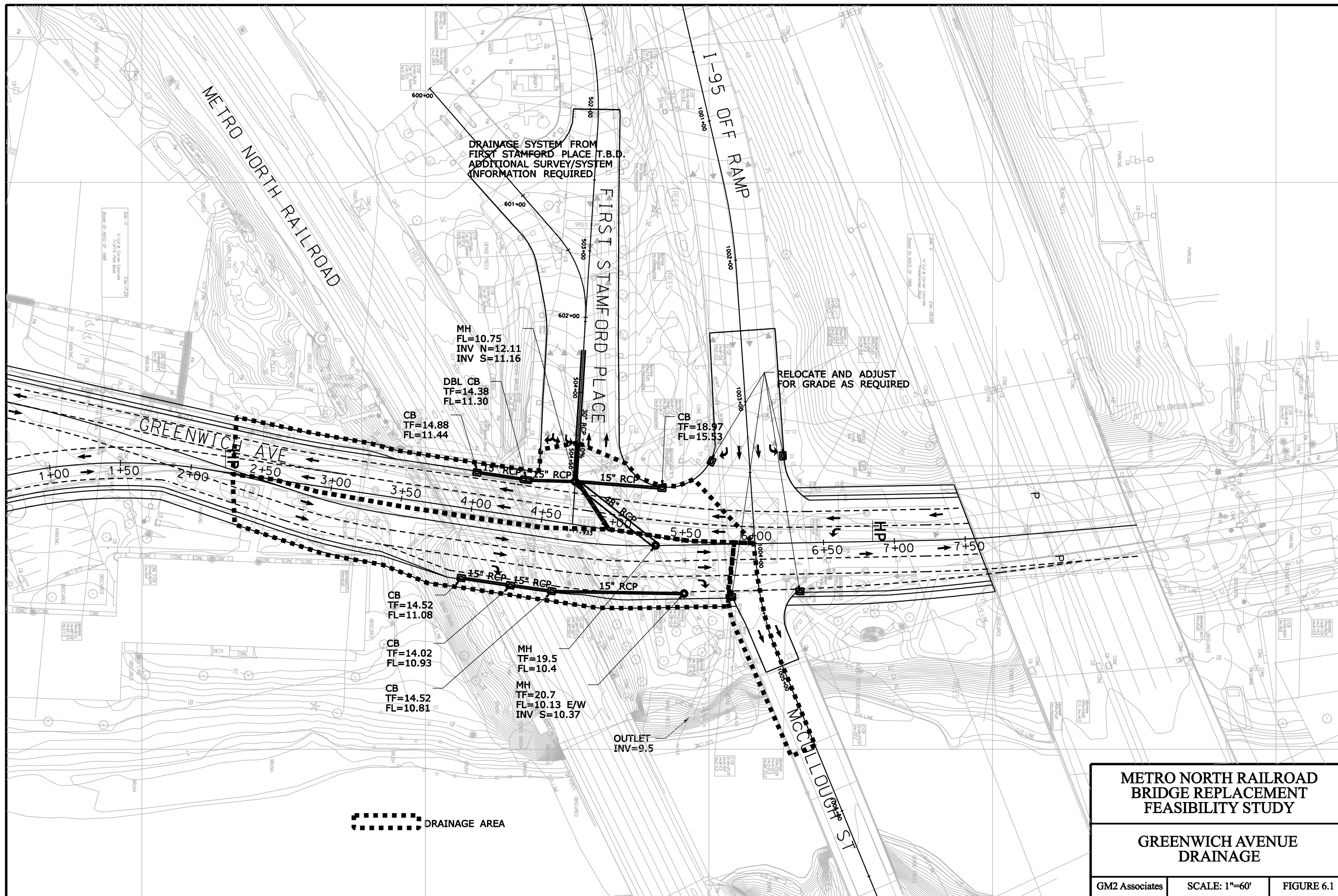

**METRO NORTH RAILROAD
BRIDGE REPLACEMENT
FEASIBILITY STUDY**

**GREENWICH AVENUE
DRAINAGE**

GM2 Associates SCALE: 1"=60' FIGURE 6.1

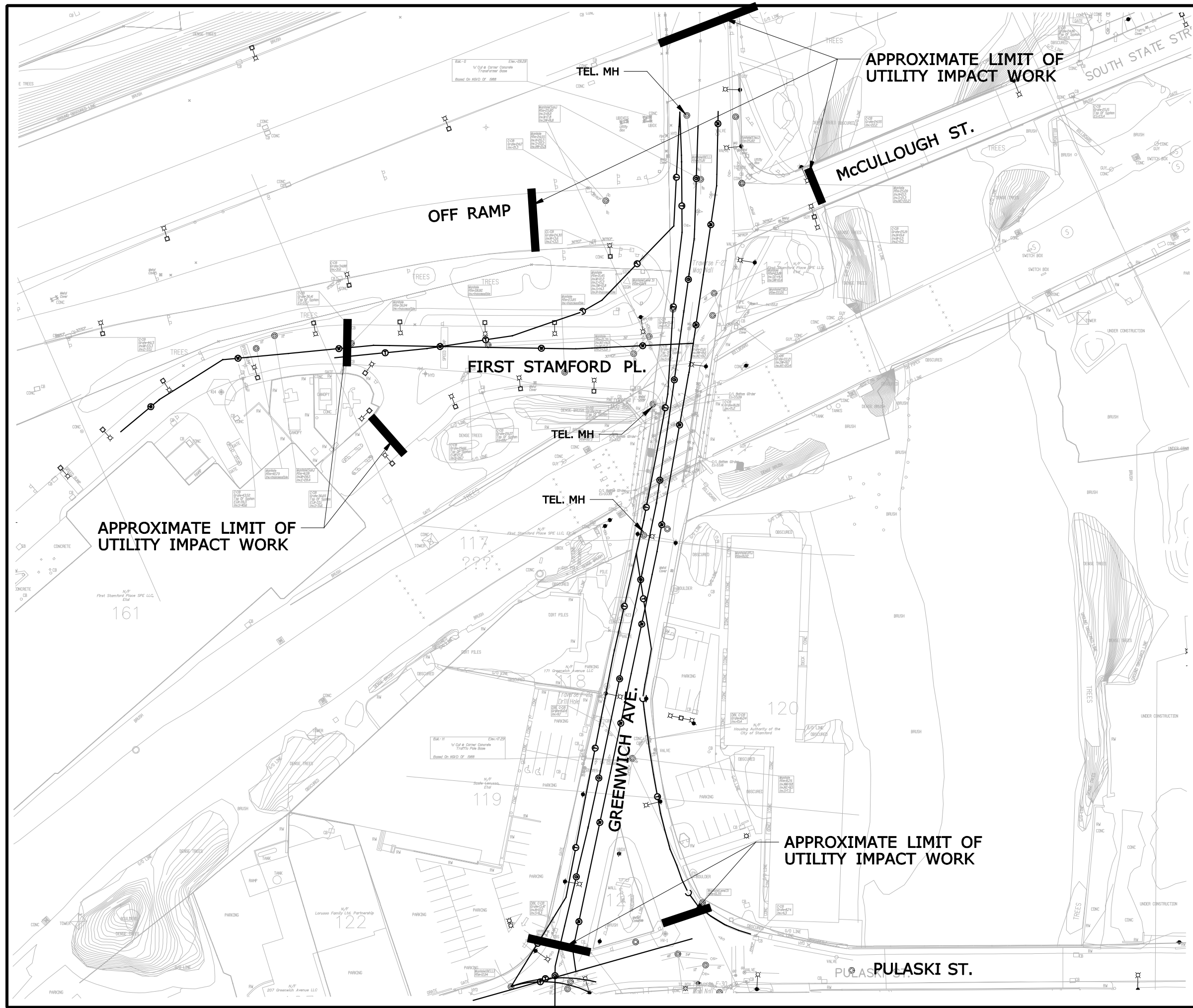

UTILITY IMPACT

- ELECTRIC:**
 - MH - 0
 - DUCT - 0'
- TELEPHONE:**
 - MH - 3
 - DUCT - 1400'
- GAS - 755'**
- WATER - 1030'**
- UTILITY POLES - 11**
- LIGHT POLES - 0**
- CITY ITS - UNDERGROUND & OVERHEAD**
- COPPER WIRES**

LEGEND

- GAS LINE
- TELEPHONE LINE
- WATER MAIN
- ELECTRIC UTILITY LINE

METRO NORTH RAILROAD BRIDGE REPLACEMENT FEASIBILITY STUDY		
GREENWICH AVENUE UTILITY PLAN		
GM2 Associates	SCALE: 1"=80'	FIGURE 7.1

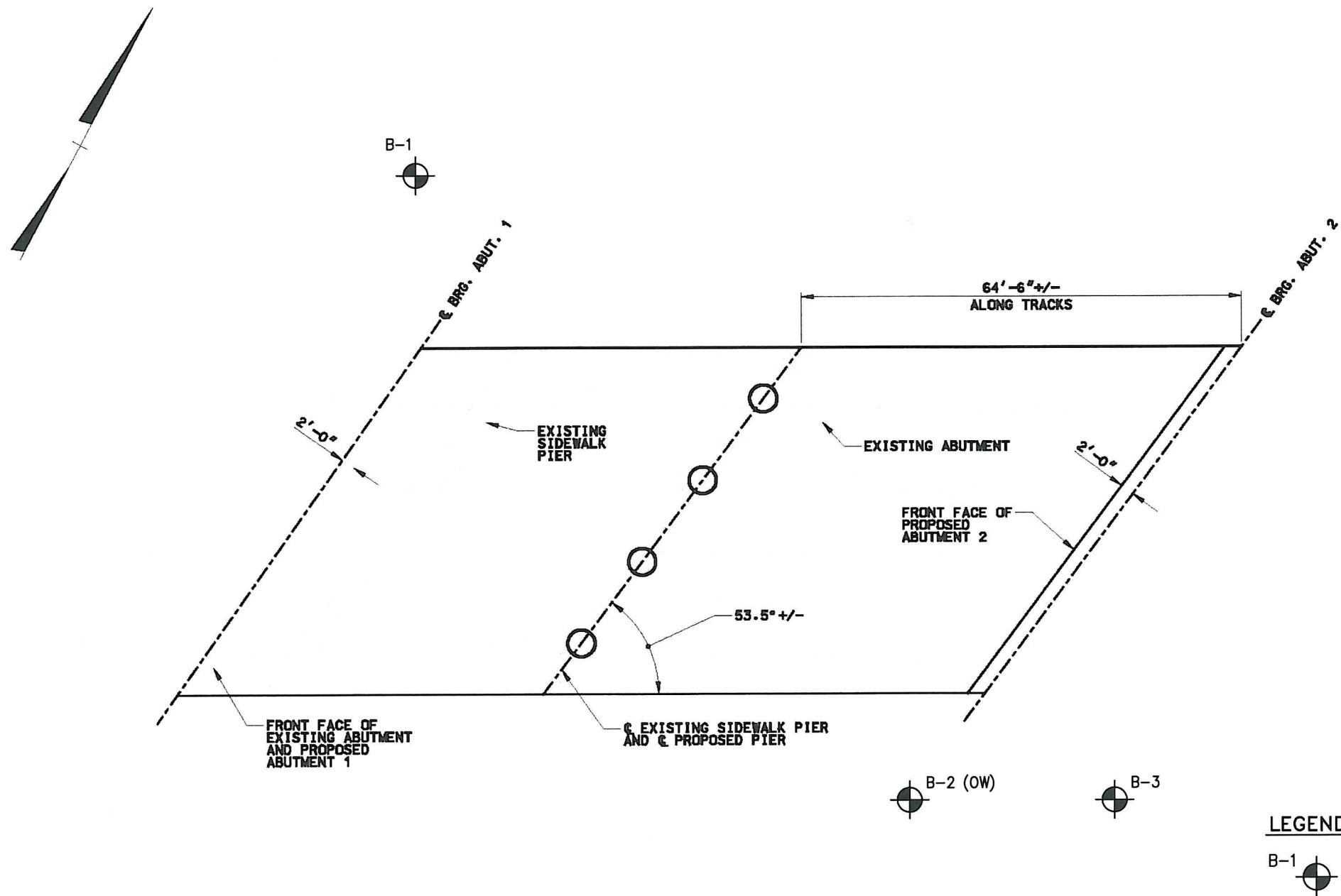

LEGEND
 B-1 PROPOSED PILOT BORING

NOTES:
 1) BASE MAP DEVELOPED FROM AN ELECTRONIC FILE PROVIDED BY URS ENTITLED 'Proposed Bridge Layout 12-22-2009.pdf' DATED 1/11/2010.
 2) THE LOCATIONS OF THE BORINGS WERE DETERMINED BY TAPING AND VISUAL ESTIMATES FROM EXISTING SITE FEATURES.

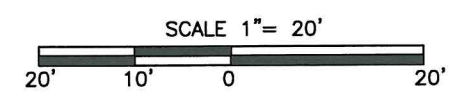

METRO NORTH RAILROAD BRIDGE REPLACEMENT FEASIBILITY STUDY		
GREENWICH AVENUE PILOT BORING PROGRAM		
URS	SCALE: 1"=20'	FIGURE 8.1

M:\A\1\01011\25\PHASE 1\CADD\GREENWICH AVE.dwg

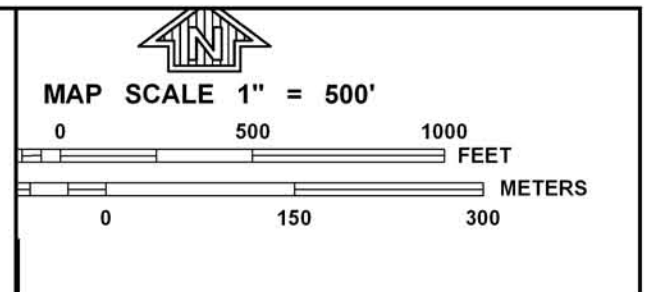
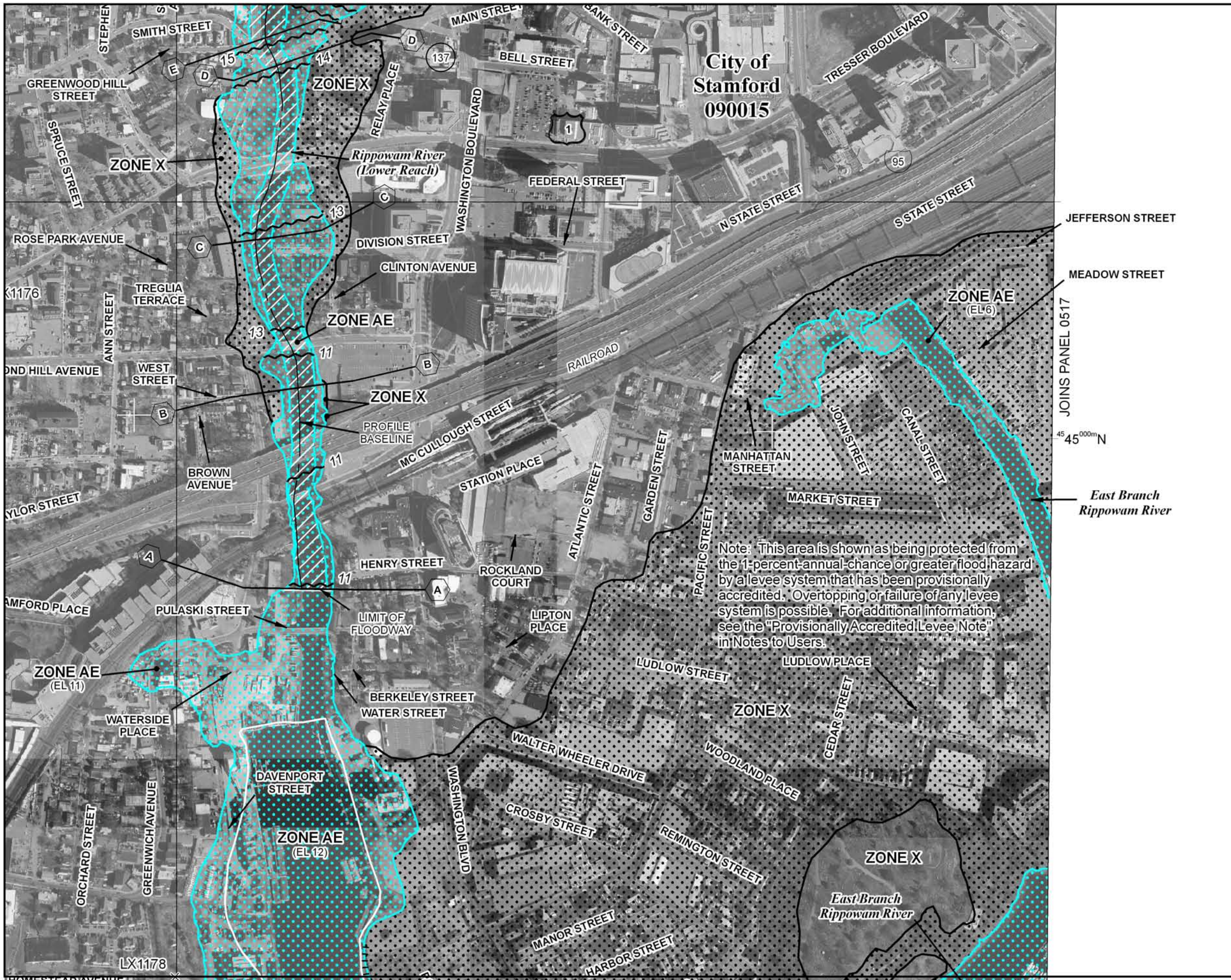

NFIP PANEL 0516F

FIRM
FLOOD INSURANCE RATE MAP

FAIRFIELD COUNTY, CONNECTICUT
(ALL JURISDICTIONS)

PANEL 516 OF 626
(SEE MAP INDEX FOR FIRM PANEL LAYOUT)

CONTAINS:

COMMUNITY	NUMBER	PANEL	SUFFIX
GREENWICH, TOWN OF	090008	0516	F
STAMFORD, CITY OF	090015	0516	F

Notice to User: The Map Number shown below should be used when placing map orders; the Community Number shown above should be used on insurance applications for the subject community.

MAP NUMBER
09001C0516F

EFFECTIVE DATE
JUNE 18, 2010

Federal Emergency Management Agency

**METRO NORTH RAILROAD
BRIDGE REPLACEMENT
FEASIBILITY STUDY**

**ATLANTIC STREET
100-YEAR FEMA FLOODPLAIN**

URS FIGURE 9.1

This is an official copy of a portion of the above referenced flood map. It was extracted using F-MIT On-Line. This map does not reflect changes or amendments which may have been made subsequent to the date on the title block. For the latest product information about National Flood Insurance Program flood maps check the FEMA Flood Map Store at www.msc.fema.gov