

Connecticut Department of Transportation

Qualified Product List

November 2023

Connecticut Department of Transportation
Bureau of Engineering and Construction
Division of Facilities & Transit
Engineering Services

Product Evaluation Committee Secretary

11/15/23
Date

Product Evaluation Committee Chairman

11/15/23
Date

David J. Kilpatrick
Transportation Supervising Engineer
Product Evaluation Committee Secretary
Division of Facilities & Transit
Engineering Services

Leo L. Fontaine, P.E.
Transportation Principal Engineer
Product Evaluation Committee Chairman
Division of Facilities & Transit
Engineering Services

Preface

This report has been developed as a means for determining what products, suppliers, manufacturers, equipment and methodologies may be used on CTDOT construction projects. The items referenced have met the approval of CTDOT in one of the following ways:

- They have been acceptable found for use by the Product Evaluation Committee
- They have been used successfully since before the establishment of a formal review process.
- They currently satisfy Department of Transportation specifications.

It should be understood that this document is open to refinement and will be under close scrutiny to ensure that the information contained herein is complete and accurate. Over the years, many items will be added and deleted.

Many products that may be used in CTDOT will not be represented in this document because they conform to a generic specification, and the approval procedure is in accordance with the standard specifications.

Helpful links:

- **[CTDOT's Product Evaluation Web Site \(Policy and Procedure for New Product Evaluation \)](#)**
- **[AASHTO Product Evaluation and Audit Solutions - Technical Service Program](#)**
- **[AASHTO Product Evaluation and Audit Solutions - DATAMINE](#)**

<p>If you have any questions, inquires or suggestions, please contact:</p>	<p><u>Technical Contact:</u></p> <p>David J. Kilpatrick Product Evaluation Committee Secretary Voice: (860) 594-3288 E-mail: David.Kilpatrick@ct.gov</p> <p><u>Administrative Contact:</u></p> <p>Leo L. Fontaine, P.E. Product Evaluation Committee Chairman Voice: (860) 594-3180 E-mail: Leo.Fontaine@ct.gov</p>
---	---

Table of Contents

Qualified Product Lists:

	Page
Title Page.....	i
Approvals.....	ii
Preface.....	iii
Table of Contents.....	iv
Addendum.....	vi
Historical listing of Connecticut DOT’s Qualified Product List(s).....	vii

Qualified Product Lists:

Detectable Warning ADA Truncated Dome Detectable Warning Systems.....	2
Erosion Control Matting.....	4
Erosion Control Matting Manufacturer/Supplier Contact Information	11
Geotextiles.....	12
Geotextile Manufacturer/Supplier Contact Information	19
Impact Attenuation Systems.....	20
Sand Barrels.....	20
Impact Attenuation Systems (Tangential).....	21
Impact Attenuation Systems (Flared).....	23
Impact Attenuation Systems (Median/Gore).....	24
Impact Attenuation Systems (Non-Gating).....	25
Impact Attenuation Systems (Non-Gating – High Incident).....	28
Pedestrian Barricade	29
Penetrating Sealer Protective Compound	31
Retroreflective Sheeting.....	33
Construction Barricade Sheeting.....	33

Continued on Next Page

Table of Contents

Retroreflective Sheeting-Continued

Traffic Drums, 42” Traffic Cones, Opposing Traffic Lane Divider, Glare Screens and Posts and Tubular Markers (Flexible) Sheeting.....	34
Traffic Cone Collar Sheeting.....	34
Construction Roll-Up Sign Sheeting.....	35
Delineator Non-Adhesive Backing Type Sheeting.....	36
Sign and Delineator Sheeting.....	37
Spray-Applied Membrane Waterproofing.....	41
Walls: Embankment Walls.....	43
Walls: Retaining Walls - Mechanically Stabilized Earth (MSE) Walls.....	44
Walls: Retaining Walls - Prefabricated Modular Walls.....	45

Department’s Non-Proprietary Roadside Safety Hardware

Parapets and Railing Designs for Bridges and Retaining Walls.....	47
Three-Cable Guide Railing and Anchorages	48
Metal Beam Rail and Anchorages.....	49
Precast Concrete Barrier Curbs.....	54
Merritt Parkway Guiderail and Anchorages.....	56
Other Safety Hardware (Metal Sign Posts, Breakaway Sign Supports, Pedestal Base and Breakaway Luminaire Transformer Base).....	59
Temporary Precast Concrete Barrier Curb.....	60

Bureau of Highway Operations - Qualified Products

Note: Products listed in this section are only qualified for maintenance work that is administered by the Connecticut Department of Transportation, Bureau of Highway Operations.

Pre-packaged Concrete Repair Material	62
Bituminous Concrete Patching Materials (Cold Applied)	64

<u>Date:</u>	<u>Item Changed</u>	<u>Page #:</u>
9/1/22	Revised Spray-Applied membrane test requirements of material thickness Note: All current listed companies were notified of this change.	43
9/1/22	Extended Expiration date for GCP Applied Technologies “Eliminator” product to April 3, 2024	44
9/1/22	Change in Futerra Mat (Erosion Control Matting) from Conwed Fibers brand to Profile Products LLC.	12
9/1/22	Chemical Anchor category eliminated due to change in Department practice announced in Engineering & Construction Directive ECD-2021-8	
9/1/22	Trinity Highway announced company rebrand name change to VALTIR, LLC with headquarters located at 15601 Dallas Parkway, Suite 525 Addison, TX 75001 Pages 22 to 30	
9/1/22	Established MASH compliant Sand Barrels (Test Level 3 barrel arrays only) listing; Plastic Safety Systems: CrashGard Sand Barrel System, TraFFix Devices: Big Sandy, Valtir (Formerly Trinity Highway):Energite III	
9/1/22	Added web link for Department’s MASH TL-4 3-Tube Curb Mount Bridge Rail drawing.	47
9/1/22	New Section Developed for Bureau of Highway Operations Qualified Products List for use by Office of Maintenance only for item Pre-packaged Concrete Repair Material	
9/14/22	Moved 3M Company Transportation Safety Division’s 3910 – White and 3914 Fluorescent Orange listed for Sign and Delineator sheeting Type IX to the category Traffic Drums, 42” Traffic Cones, Opposing Traffic Lane Divider, Glare Screens and Posts and Tubular Markers (Flexible) Retroreflective Sheeting Type IV.	31
10/13/22	Removed The Reinforced Earth Company product “ Pyamid Modular Blockwall” no longer available on East Coast	
10/13/22	Updated product address information for The Reinforced Earth Company’s product in QPL to 45610 Woodland Rd, Suite 200 Sterling, VA 20166 Telephone No. 978-764-7315	
10/13/22	Updated the “T-Wall Retaining Wall System” to The Reinforced Earth Company. The Neel Company and The Reinforced Earth Company merged in 2018.	
12/22/22	American Engineering Fabrics In. New Bedford MA – out of business – Geotextile	

- 12/27/22 Updated product address information for B. Metcalf Asphalt product in the QPL to 235 East Canaan Rd East Canaan, CT 06024
 - 12/22/22 Big R Bridge Corp. - Now- CONTECH ENGINEERED SOLUTIONS
 - 1/5/23 Contech is no longer distributing rolls of; Ero-Mat, Ero-Mat Hi-Velocity and Ero-Mat Standard products – Company an product line removed from table.
 - 2/3/23 Keystone Retaining Wall Systems no longer offers the “KeySystem I Retaining Wall” for Embankment Wall applications. 44
 - 2/3/23 Big R Bridge Corporate purchased by Contech Engineering Solutions in 2018. Listing changed for Vist-A-Wall Systems for retaining wall applications
 - 3/7/23 Lindsay Transportation Solutions will no longer provide their TAU II-R and there is limited amount of cartridge inventory for sale on spare parts. Item was removed from QPL Impact Attenuation Systems (Non-Gating) table.
 - 6/26/23 Bituminous Concrete Patching Material (Cold Applied) moved to the new QPL section dedicated to Bureau of Highway Operations Qualified Products List for use by Office of Maintenance for Products utilized exclusively for Contracts Administrated by Maintenance. Revised pre-approval criteria to bulk supplied only, eliminated all bagged or bucket supplied material from category.
 - 5/4/23 Revised All National Transportation Product Evaluation Program (NTPEP) references to indicate AASHTO Product Evaluation and Audit Solutions
 - 7/31/23 Contacted all manufacturer /suppliers listed in the Department’s QPL report and implemented the following to identify Product’s BABA compliance;
 - If Compliant – product listed
 - If not compliant according to manufacturer or unknown - **Product name Shaded**
 - If no contact established – product removed.
 - 7/11/23 Revised Penetrating Sealer Protective Compound prequalification criteria.
 - 11/2/23 Extended Wasser Coatings Inc. Wasser Polyflex Bridge Deck System product’s Nov. 7, 2023 expiration date to April 1, 2024. Product remains “Qualified” while test data is under review.
-

Historical listing of Connecticut Department of Transportation Qualified Product List(s)

Posting Date Report Link

- August 2021 Link [CTDOT-Qualified-Product-List \(August 2021 Posting\).pdf](#)
- March 2020 link - [CTDOT- Qualified-Product-List \(March 2020 Posting \)](#)
- June 2019 link - [CTDOT- Qualified-Product-List \(June 2019 Posting \)](#)

NOTE: Current Qualified Products List; is available through the Department’s Website by selecting “Doing Business with CTDOT”, a link is provided to the current Qualified Products List is located in the right hand column of items as you scroll down the web page, listed under the major category of “Standards and Specifications” click on “[CTDOT Qualified Product List](#)

Qualified Product Lists – Continued

The following pages contain lists, which are directly referenced in either the standard specifications or in special provisions as Qualified Products Lists (QPL). These lists will be updated annually, and no product may be used in these categories unless it is shown on an appropriate list.

Detectable Warning – (ADA Truncated Dome Detectable Warning Systems)

SPECIFICATION: Standard Specification Section 9.21

PREQUALIFICATION CRITERIA: AMS-STD-595 Color #22144

Manufacturer/Supplier	Product Brand Name
Access Products Inc. 241 Main Street, Suite 100 Buffalo, NY 14203 Telephone: 888-679-4022 Website: www.accessproducts.com	Access Tile Detectable Warning Tiles
ADA Solutions, Div. of SureWerx USA 323 Andover Street Suite 3 Wilmington, MA 01887 Telephone: 800-372-0519 Website: www.adatile.com	Detectable Warning Tile: Iron Dome Cast-In-Place Tactile Surface Applied Tactile (Retrofit) Cast-In-Place Replaceable Tactile
Armor-Tile 300 International Drive, Suite 100 Williamsville, NY 14221 Telephone: 800-682-2525 Website: www.armor-tile.com/	Armor-Tile Tactile System: Cast-In-Place System Surface Applied System (Retrofit)
Detectable Warning Systems, Div. of Mar-Bal, Inc. 3205 Randall Parkway, Ste 215 Wilmington, NC 28403 Telephone: 866-999-7452 Website: www.detectable-warning.com	AlertTile - Surfaced Applied AlertCast – Cast in- Place

[Posted Nov. 23 - Table Last Revised 3/15/23]

Continued on Next Page:

Qualified Product Lists – Continued

Detectable Warning Products – Continued:

Manufacturer/Supplier	Product Brand Name
EJ USA, Inc. 1125 Pearl Street Brockton, MA 02301 Telephone: 508-586-3130 Website: www.ejco.com	DURALAST Detectable Warning Plates Cast Iron Uncoated Natural Finish
TufTile Inc. 1200 Flex Court Lake Zurich, IL 60047 Telephone: 888-960-8897 Website: www.tuftile.com	Cast Iron Wet Set (cast-in-place) 10 GA Galvanized Powder Coated Steel (wet-set) Polymer Wet-Set (cast-in-place) Polymer Surface-Applied

[Posted Nov. 23 - Table Last Revised 8/22/23]

Qualified Product Lists – Continued

Erosion Control Matting

SPECIFICATION: Standard Specification Section 9.50 & M.13.09

PREQUALIFICATION CRITERIA: See below.

In general, organic materials are cheaper than synthetics, will photo-degrade after a period of time leaving a naturally vegetated area, and are adequate for channels that are expected to carry storm water flows not exceeding 95.76 Pa shear stress. Synthetic materials generally do not photo-degrade and often remain as a permanent element within a drainage channel; Although more expensive, synthetic materials are generally best for critical channels which will carry higher flows or velocities of storm water runoff.

Minimum Performance Standards

Erosion control matting is evaluated for use in eight Types, grouped in two Classes. In order for a product to be placed upon the Department’s Qualified Products List, it must meet the following Minimum Performance Standards.

Class 1: Slope Protection – Classification is based upon steepness of slope and soil type. The purpose is to protect the seedbed from loss of sediment and promote the establishment of a warm season, perennial vegetative cover.

- Type A. Slopes 3:1 or Flatter – Clay Soils
- Type B. Slopes 3:1 or Flatter – Sandy Soils
- Type C. Slopes Steeper than 3:1 – Clay Soils
- Type D. Slopes Steeper than 3:1 – Sandy Soils

Minimum Acceptable Vegetation Density Standards¹

	<u>Clay Soils</u>	<u>Sandy Soils</u>
Slopes 3:1 or Flatter	80%	70%
Slopes Steeper than 3:1	80%	70%

Minimum Acceptable Sediment Loss Standards (kg/10 m²)¹

	<u>Clay Soils</u>	<u>Sandy Soils</u>
Slopes 3:1 or Flatter	0.35	12.00
Slopes Steeper than 3:1	0.35	27.00

Continued on Next Page:

Qualified Product Lists – Continued

Erosion Control Matting - Continued:

Class 2: Flexible Channel Liner Protection – Classification is based upon the permissible shear stress² (T_p) present. The purpose is to protect the geometry of the channel from loss of sediment, and to promote the establishment of a warm-season, perennial vegetative cover.

- Type E. Permissible shear stress: <25 Pa
- Type F. Permissible shear stress: 25 to <50 Pa
- Type G. Permissible shear stress: 50 to <100 Pa
- Type H. Permissible shear stress: \geq 100 Pa

T_p , the permissible shear stress, indicates the force required to initiate the movement of the lining material.

Minimum Acceptable Vegetation Density Standards¹

70%

Minimum Acceptable Sediment Loss Standards¹

	<u>Average Soil Deformation (cm)</u>
Shear Stress 1 to 100 Pa	1.15
Shear Stress > 100 Pa	1.00

It should be recognized that those products listed by brand or trade name on the Qualified Products List have demonstrated their ability to meet or exceed the Department's minimum Performance standards. It is the Contractor's option as to which product he or she actually uses on a project, provided that the product used is on the Qualified Products List for that application.

It will be the District's responsibility to verify that the Erosion Control Matting proposed by the Contractor is, in fact, listed as an acceptable product on the Qualified Products List.

It should also be recognized that the decision to undergo testing for possible approval rests solely with the manufacturers or distributors of Erosion Control Matting. The Department has created a fair but rigorous testing process for Erosion Control Matting. The Department does not choose or stipulate which products are to be tested.

The Department's position is that, while we encourage the evaluation of new products for possible use in our operations, we cannot accept a product that has not been tested and approved through the Department's evaluation process.

Continued on Next Page:

Qualified Product Lists – Continued

Erosion Control Matting - Continued:

As new products are tested on an annual basis, those meeting our requirements will be added to the Qualified Products List. If, by the time actual field installation of Erosion Control Matting commences on a project, new products have been added to the Qualified Products List, the Contractor may elect to use these newly approved products even though they were not an “approved” product at the time bids were received on the project.

¹ Final Performance Analysis – 1995 Evaluation Cycle, Texas DOT/Texas Transportation Institute, Hydraulics and Erosion Control Laboratory, February 1996.

² Shear Stress ranges based on values published in FHWA Hydraulic Engineering Circular No. 15 (HEC-15), Design of Roadside Channels with Flexible Linings, Publication No. FHWA-ZP-87-7, April 19

Continued on Next Page:

Qualified Product Lists – Continued

Erosion Control Matting - Continued:

Manufacturer/Supplier		Class 1: Slope Protection *				Class 2: Flexible Channel Type Protection			
		Type A	Type B	Type C	Type D	Type E*	Type F*	Type G*	Type H**
American Excelsior Company									
	AEC Premier Coconut	X	X	X	X		X		
	AEC Premier Straw/Coconut	X	X	X	X	X	X		
	AEC Premier StrawDoubleNet	X	X	X	X	X	X		
	AEC Premier StrawSingleNet	X	X						
	Bindex BFM	X	X	X	X				
	Curlex Enforcer					X	X	X	X
	Curlex I	X	X	X	X				
	Curlex I CL	X	X	X	X				
	Curlex II	X			X	X	X		
	Curlex II CL		X		X	X	X		
	Curlex III					X	X		
	Curlex NetFree	X	X		X				
	Recyclex					X	X	X	X
	Recyclex TRM-V					X	X	X	X
Belton Industries									
	Geocoir/DeKoWe 700				X				
	Geocoir/DeKoWe 900				X				
Enviroscape ECM									
	C4000			X	X		X		
	C4000BD			X	X		X		
	S1000	X	X			X			
	S1000BD	X	X			X			
	S2000	X	X			X			
	S2000BD	X	X			X			
	SC3000	X	X			X			
	SC3000BD	X	X			X			

* Products listed in this category are generally temporary (bio- or photo-degradable). Exceptions are noted.

[Posted Nov. 23 – Table last revised 10/30/23]

** Products listed in this category are generally permanent (non-bio- or non-photo-degradable). Exceptions are noted.

TYPE E – Generally includes, but is not limited to, Woven Paper Net, Jute Net.

TYPE F – Generally includes, but is not limited to, Fiberglass Roving (single or double).

TYPE G – Generally includes, but is not limited to, Straw with Net, Curled Wood Mat.

TYPE H – Generally includes, but is not limited to, Synthetic Net.

Continued on Next Page

Qualified Product Lists – Continued

Erosion Control Matting - Continued:

		Class 1: Slope Protection *				Class 2: Flexible Channel Type Protection			
Manufacturer/Supplier		Type A	Type B	Type C	Type D	Type E*	Type F*	Type G*	Type H**
Erosion Control Blankets									
	P42					X	X	X	X
	S31	X	X						
	S31 UVD	X	X						
	S32			X	X	X	X		
	S32 UVD			X	X	X	X		
Profile Products LLC									
	Futerra Mat	X	X						
US Erosion Control Products									
	US-1S							X	
	US-2C							X	
	US-2S							X	
Western Excelsior Corporation.									
	Excel PP5-8					X	X	X	
	Excel PP5-10							X	X
	Excel PP5-12							X	X
	Excel R-1	X	X						
	Excel S-2	X	X	X	X	X			
	Excel SD-3					X	X		
	Excel SR-1	X	X						
	Excel SS-2	X	X	X	X				

* Products listed in this category are generally temporary (bio- or photo-degradable). Exceptions are noted.

[Posted Nov. 23 – Table last revised 10/30/23]

** Products listed in this category are generally permanent (non-bio- or non-photo-degradable). Exceptions are noted.

TYPE E – Generally includes, but is not limited to, Woven Paper Net, Jute Net.

TYPE F – Generally includes, but is not limited to, Fiberglass Roving (single or double).

TYPE G – Generally includes, but is not limited to, Straw with Net, Curled Wood Mat.

TYPE H – Generally includes, but is not limited to, Synthetic Net.

Continued on Next Page

Qualified Product Lists – Continued

Erosion Control Matting - Continued:

Manufacturer/Supplier		Class 1: Slope Protection *				Class 2: Flexible Channel Type Protection			
		Type A	Type B	Type C	Type D	Type E*	Type F*	Type G*	Type H**
Western Green									
	EC – 7Y		X		X				
	EC – 9Y		X		X				
	ECC - 3			X	X	X	X	X	X
	ECP - 2 T-RECS					X	X	X	X
	ECP - 3					X	X	X	X
	ECSC - 3					X	X	X	X
	ECX - 1	X	X	X	X				
	ECX - 2	X	X	X	X				
	Excel CC-4			X	X	X	X	X	X
	Excel CC-4 All Natural			X	X	X	X	X	X
	Excel CS-3	X	X	X	X				
	Excel CS-3 All Natural	X	X	X	X				
	Excel ECSC-2 Natural	X	X	X	X				
	Excel ECSC-3 All Natural	X	X	X	X				
	Excel SR-1	X	X						
	Excel SR-1 All Natural	X	X						
	Excel SR-1 Rapid Go	X	X						
	Excel SS-2	X	X	X	X				
	Excel SS-2 All Natural	X	X	X	X				
	Excel SS-2 Rapid Go	X	X	X	X				
	PP5 - 10 oz					X	X	X	X
	PP5 - 12 oz			X	X				

* Products listed in this category are generally temporary (bio- or photo-degradable). Exceptions are noted.

** Products listed in this category are generally permanent (non-bio- or non-photo-degradable). Exceptions are noted.

TYPE E – Generally includes, but is not limited to, Woven Paper Net, Jute Net.

TYPE F – Generally includes, but is not limited to, Fiberglass Roving (single or double).

TYPE G – Generally includes, but is not limited to, Straw with Net, Curled Wood Mat.

TYPE H – Generally includes, but is not limited to, Synthetic Net.

[Posted Nov. 23 – Table last revised 10/30/23

Continued on Next Page

Qualified Product Lists – Continued

Erosion Control Matting - Continued:

Manufacturer/Supplier		Class 1: Slope Protection *				Class 2: Flexible Channel Type Protection			
		Type A	Type B	Type C	Type D	Type E*	Type F*	Type G*	Type H**
North American Green (Part of Western Green)									
	C125				X	X			
	C125BN				X	X			
	C350 Biodegradable								X
	P300					X	X	X	X
	S150	X	X	X	X				
	S150BN	X	X	X	X				
	S75	X	X						
	S75BN	X	X						
	SC150	X	X	X	X				
	SC150BN	X	X	X	X				

* Products listed in this category are generally temporary (bio- or photo-degradable). Exceptions are noted.

[Posted Nov. 23 – Table last revised 10/30/23

** Products listed in this category are generally permanent (non-bio- or non-photo-degradable). Exceptions are noted.

TYPE E – Generally includes, but is not limited to, Woven Paper Net, Jute Net.

TYPE F – Generally includes, but is not limited to, Fiberglass Roving (single or double).

TYPE G – Generally includes, but is not limited to, Straw with Net, Curled Wood Mat.

TYPE H – Generally includes, but is not limited to, Synthetic Net.

Continued on Next Page

Qualified Product Lists – Continued

Erosion Control Matting - Continued:

Erosion Control Matting Company's Contact Information							
Manufacturer/Supplier	Street	City/Town	State	ZIP	Website	Email	Telephone
American Excelsior Company	831 Pioneer Avenue	Rice Lake	WI	54868	americanexcelsior.com	cshultz@americanexcelsior.com	715-475-9063
Belton Industries	8613 Roswell Rd	Atlanta	GA	30350			
Enviroscape ECM	300 S Chestnut St	Deshler	OH	43516	strawblanket.com	info@strawblanket.com	1-888-550-1999
Erosion Control Blankets	P.O. Box 69	Riverton	MB	R0C 2RO			
North American Green (Part of Western Green)	14649 Highway 41	Evansville	IN	47711			
Profile Products LLC	750 Lake Cook Rd #440	Buffalo Grove	IL	60089	www.profileevs.com	ldem@profileproducts.com	808-312-7671
US Erosion Control Products	1034 Albany Avenue W.	Pearson	GA	31642			
Western Excelsior Corporation.	4609 E Boonville-New Harmony Rd	Evansville	IN	47725			
Western Green	443 Bricker Rd.	Bernville	PA	19506	www.westerngreen.com		

[Posted Nov. 23 – Table last revised 10/30/23

Qualified Product Lists – Continued

Geotextiles:

SPECIFICATION: Standard Specification, Sections 2.19, 7.51, 7.55 and M.08.01-19

PREQUALIFICATION CRITERIA:

The following list denotes those geotextiles that are approved for use on CTDOT projects. The categories listed are in accordance with the AASHTO M 288 specification. Geotextile selection shall be based on the following definitive information and the applicable design criteria.

1. **Subsurface Drainage** – Geotextiles within this category shall be used for, but not limited to, the following applications: pavement edge drains; interceptor drains; wall drains; recharge basins and relief wells. The geotextile shall be designed to allow the passage of water normal to its surface while retaining in situ soil without clogging. Class A drainage applications for fabrics are where installation stresses are more severe than Class B applications, i.e., very coarse, sharp, angular aggregate is used; a heavy degree of compaction (95% or greater by AASHTO method T 99) is specified; or, depth of trench is greater than 3.00 m. Class B drainage applications are those where the fabric is used with smooth graded surfaces having no sharp angular projections, no sharp angular aggregate is used; compaction requirements are light (less than 95% by AASHTO method T 99); and, trenches are less than 3.00 m in depth.
2. **Sediment Control** – Geotextiles within this category shall be used as a barrier-fence designed to remove suspended particles from the water that passes through it. “Wire Supported” signifies that fabric is supported with a mesh made of wire or plastic.
3. **Erosion Control** – Geotextiles within this category shall be used for, but not limited to, the following applications: cut and fill slope protection; protection of various small drainage structures and ditches, wave protection for causeways and shoreline roadway embankments; and, scour protection for structures such as bridges and abutments. The geotextile shall be designed to allow the passage of water while retaining in situ soil without clogging. Class A erosion control applications are those where the fabrics are used under conditions where installation stresses are more severe than Class B, i.e., aggregate placement height should be less than 1.00 m; and, aggregate weights should not exceed 115.00 kg. Class B erosion control applications are those where the fabric is used in structures or under conditions where the fabric is protected by a sand cushion or by “zero drop height” placement of aggregate.
4. **Separation** – Geotextiles within this category shall be used for, but are not limited to, the following applications: separation of dissimilar materials, such as subgrades and pavement base courses and zones in embankments, foundations and select fill materials. When soil stabilization is the primary concern, the Design Engineer is cautioned that a detailed process must be followed, taking into consideration not only the separation properties of the geotextile, but its reinforcement function as well. The geotextile shall be designed to allow the passage of water while retaining in situ soil without clogging.

Continued on Next Page:

Qualified Product Lists – Continued

Geotextiles - Continued:

Manufacturer/Supplier	Subsurface Drainage		Sediment Control		Erosion Control		Separation	
	Class A	Class B	Wire Supported	Self Supported	Class A	Class B	High Survivability	Medium Survivability
Advanced Drainage, Inc.								
2 x 2 [GTX-2021-01-106]	X	X	X	X	X		X	X
104F [GTX-2021-01-099]			X	X		X		
200W [GTX-2021-01-100]			X	X				
250W [GTX-2021-01-101]			X	X				X
315W [GTX-2021-01-102]			X	X			X	X
351T [GTX-2021-01-109]			X	X				
370HP [GTX-2021-01-116]			X	X			X	X
401T [GTX-2021-01-110]			X					
451T [GTX-2021-01-111]			X					
601T [GTX-2021-01-112]		X	X	X				X
701T [GTX-2021-01-113]	X	X	X	X	X		X	X
801T [GTX-2021-01-114]	X	X	X	X	X		X	X
3302WP [GTX-2020-01-246]			X	X				

* Product is satisfactory only where the affected soil contains less than 50% material, by weight, passing the number 200 sieve.

[Posted Nov 23 Table Last Revised 10/13/23]

Continued on Next Page

Qualified Product Lists – Continued

Geotextiles – Continued:

Manufacturer/Supplier	Subsurface Drainage		Sediment Control		Erosion Control		Separation	
	Class A	Class B	Wire Supported	Self Supported	Class A	Class B	High Survivability	Medium Survivability
Belton Industries, Inc								
307		X		X		X		
308		X						
751		X						
768	X	X						X
769	X	X			X	X		
940			X	X		X		
977	X	X						X
1475	X	X			X	X	X	X
Carthage Mills								
FX-35HS		X				X		
FX-40HS		X				X		
FX-11			X	X				
FX-55*					X	X		X
FX-66					X	X	X	X
Hanes GEO Components								
Terratex: EP	X	X					X	X
Terratex: GS*								
Terratex: GS-150*						X		
Terratex: HD*							X	X
Terratex: N04		X				X		
Terratex: N08	X	X			X			X
Terratex: S04		X						
Terratex: SC			X	X				
Terratex: SC-90			X	X				
Terratex: SD		X				X		

* Product is satisfactory only where the affected soil contains less than 50% material, by weight, passing the number 200 sieve. .

[Posted Nov 23 Table Last Revised 10/13/23]

Continued on Next Page

Qualified Product Lists – Continued

Geotextiles – Continued

Manufacturer/Supplier	Subsurface Drainage		Sediment Control		Erosion Control		Separation	
	Class A	Class B	Wire Supported	Self Supported	Class A	Class B	High Survivability	Medium Survivability
Indian Valley Industries Inc.								
CT-3611			X	X		X		
Mutual Industries Inc.								
MISF 1830			X	X				
MISF 1855			X	X				
Propex Geosolutions								
102F	X				X	X		
104F	X				X	X		
117F				X				
135ST	X							
200ST	X	X			X	X		X
311		X						
315ST					X	X	X	X
351		X				X		
401	X	X				X		
451		X				X		X

* Product is satisfactory only where the affected soil contains less than 50% material, by weight, passing the number 200 sieve. .

[Posted Nov 23 Table Last Revised 10/13/23]

Continued on Next Page

Qualified Product Lists – Continued

Geotextiles – Continued

Manufacturer/Supplier	Subsurface Drainage		Sediment Control		Erosion Control		Separation	
	Class A	Class B	Wire Supported	Self Supported	Class A	Class B	High Survivability	Medium Survivability
Propex Geosolutions								
501		X						X
601		X				X		X
701	X	X					X	X
801	X	X			X	X	X	X
1071	X	X			X	X	X	X
1291	X	X			X	X	X	X
1701	X	X			X	X	X	X
2130				X				
2x2HF								X
SKAPS Industries								
GT131		X						
GT135		X	X			X		
GT140		X				X		X
GT142		X				X		X
GT170	X							
GT180	X				X			X
M706	X	X			X			X
SW200					X	X		X
SW315					X	X		X
W100			X	X				

* Product is satisfactory only where the affected soil contains less than 50% material, by weight, passing the number 200 sieve. .

[Posted Nov 23 Table Last Revised 10-13-23]

Continued on Next Page

Qualified Product Lists – Continued

Geotextiles – Continued

Manufacturer/Supplier	Subsurface Drainage		Sediment Control		Erosion Control		Separation	
	Class A	Class B	Wire Supported	Self Supported	Class A	Class B	High Survivability	Medium Survivability
TenCate Geosynthetics								
135N		X						
140N		X				X		X
140NC		X						
140NL		X				X		
170N	X						X	
180N	X				X		X	
500X					X*	X*		X*
550X								X
600X					X*	X*	X*	X*
FW404	X	X		X	X	X	X	
FW500	X	X	X	X	X	X	X	X
FW700	X	X	X	X	X	X	X	X
HP370							X	
US Silt & Site Supply/GetSco								
CT3611213			X	X				

* Product is satisfactory only where the affected soil contains less than 50% material, by weight, passing the number 200 sieve. .

[Posted Nov 23 Table Last Revised 12-29-22]

Continued on Next Page

Qualified Product Lists – Continued

Geotextiles – Continued

Manufacturer/Supplier	Subsurface Drainage		Sediment Control		Erosion Control		Separation	
	Class A	Class B	Wire Supported	Self Supported	Class A	Class B	High Survivability	Medium Survivability
Willacoochee Industrial Fabrics								
WINFAB: 77SF			X					
WINFAB: 105SF				X				
WINFAB: 200W	X				X	X		X
WINFAB: 315W					X	X	X	X
WINFAB: 400N	X					X		
WINFAB: 600N		X				X		X
WINFAB: 700N	X	X				X	X	X
WINFAB: 800N	X	X			X	X	X	X
WINFAB: 1000NE	X	X			X	X	X	X
WINFAB: 2199	X				X	X		
WINFAB: 2x2HF							X	X

* Product is satisfactory only where the affected soil contains less than 50% material, by weight, passing the number 200 sieve. .

[Posted Nov 23 Table Last Revised 12/29/22]

Continued on Next Page

Qualified Product Lists – Continued

Geotextiles – Continued

Geotextile Company’s Contact Information						
Manufacturer/Supplier	Street	City/Town	State	ZIP	Website	Email
Advanced Drainage Systems, Inc.	4640 Trueman Blvd	Hilliard	OH	43026	www.adspipe.com	greg.baryluk@ads-pipe.com
A.H. Harris & Sons, Inc	91 Holmes Road	Newington	CT	06131		
Berry Global Inc.	70 Old Hickory Blvd	Old Hickory	TN	37138		
Belton Industries, Inc.	P.O. Box 127	Belton	SC	29627	boomenviro.com	
Carthage Mills	4243 Hunt Rd	Cincinnati	OH	45242	carthagemills.com	
Hanes GEO Components	815 Buxton St	Winston-Salem	NC	27101	www.hanesgeo.com	
Hoechst Celanese Corp.	P.O. Box 5650	Spartanburg	SC	29304		
Indian Valley Industries	60 – 100 Corliss Ave.	Johnson City	NY	13790		
LINQ Industrial	4550 W. Fifth North St.	Summerville	SC	29483		
Mutual Industries Inc.	707 West Grange St	Philadelphia	PA	19120		
Propex Geosolutions	6025 Lee Highway Suite 425 PO Box 22788	Chattanooga	TN	37422	geotextile.com	
SKAPS Industries	335 Athena Dr	Athens	GA	30601		
TenCate Geosynthetics	365 South Holland Dr.	Pendergrass	GA	30567	www.tencategeo.us	
TNS Advanced Technologies, Inc.	681 DeYoung Rd	Greer, SC 29651	SC	29651		
US Silt & Site Supply	75 Dow Rd	Bow	NH	03304	ussilt.com	
Willacoochee Industrial Fabrics	1 Nashville Mills Rd	Nashville	GA	31650	www.winfabusa.com	info@winfabusa

[Posted Nov 23 Table Last Revised 10/13/23]



Qualified Product Lists – Continued

Impact Attenuation Systems:

SPECIFICATION: Standard Specification Section 18.02 SAND BARRELS

PREQUALIFICATION CRITERIA: Crash Tested in accordance with “AASHTO Manual for Assessing Safety Hardware (MASH)” Test Level 3 non-redirective, gating crash cushion criteria.

Comments: For all attenuators, see the [CTDOT Highway Design Manual](#) for guidance.

Sand Barrels				
ROADWAY SAFETY HARDWARE	Manufacturer	Testing Criteria	Test Level	Approval Basis
CrashGard Barrels	Plastic Safety Services	MASH 2016	TL-3	CC-145
				
				Related Documents
				Hardware Drawing
				Installation Manual
				CrashGard (MASH Tested 12 Barrel Array)
Big Sandy	Traffix Devices	MASH 2016	TL-3	CC-139
				
				Related Documents
				Hardware Drawing
				Installation Manual
				Big Sandy (MASH Tested 12 Barrel Array)
Energite III	Valtir (Formerly Trinity Highway)	MASH 2016	TL-3	CC-164
				
				Related Documents
				Hardware Drawing
				Installation Manual
				Energite III (MASH Tested 12 Barrel Array)

[Posted Nov 23 Table last revised on 7/13/22]

Impact Attenuation Systems - Continued:



Qualified Product Lists – Continued

Impact Attenuation Systems (Tangential)

SPECIFICATION: Standard Specification Section 18.03 IMPACT ATTENUATION SYSTEM

PREQUALIFICATION CRITERIA: Crash Tested in accordance with “AASHTO Manual for Assessing Safety Hardware (MASH)” Test Level 3 criteria; or, crash tested in accordance with “National Cooperative Highway Research (NCHRP) Report 350 – Recommended Procedures for the Safety Performance Evaluation of Highway Features” Test Level 3 criteria.

Comments: For all attenuators, see the [CTDOT Highway Design Manual](#) for guidance.



Impact Attenuation Systems (Tangential)				
ROADWAY SAFETY HARDWARE	Manufacturer	Testing Criteria	Test Level	Approval Basis
SoftStop	Valtir (formerly Trinity Highway)	MASH 2016	TL-3	CC-115*
	Related Documents Hardware Drawings Installation Manual			
MSKT-SP	Road Systems, Inc.	MASH 2016	TL-3	CC-126*
	Related Documents Hardware Drawing(s) Installation Manual MSKT - Components			
Max-Tension	Lindsey Transportation Solutions	MASH 2016	TL-3	CC-133
	Related Documents Installation Manual			

Note: CC-####* is FHWA HARDWARE ELIGIBILITY LETTER
[Posted Nov 23 Table last revised on 3/20/20]

Continued on Next Page:

Qualified Product Lists – Continued

Impact Attenuation Systems (Tangential) - Continued:

Impact Attenuation Systems (Tangential)				
ROADWAY SAFETY HARDWARE	Manufacturer	Testing Criteria	Test Level	Approval Basis
SKT-SP	Road Systems, Inc.	NCHRP 350	TL-3	CC-88*
	** FOR REPAIR ONLY UNLESS SPECIFIED **			
	ON CONTRACT DRAWINGS			
	Related Documents			
	Hardware Drawing(s)			
	Installation Manual			
BEAT-MT	Road Systems, Inc.	NCHRP 350	TL-3	CC-69*
	Related Documents			
	Hardware Drawing(s)			
	Installation Manual			

Note: CC-###* is FHWA HARDWARE ELIGIBILITY LETTER
[Posted Nov 23 Table last revised on 3/20/20]

Continued on Next Page:



Qualified Product Lists – Continued

Impact Attenuation Systems (Flared)

SPECIFICATION: Standard Specification Section 18.03 IMPACT ATTENUATION SYSTEM

PREQUALIFICATION CRITERIA: Crash Tested in accordance with “AASHTO Manual for Assessing Safety Hardware (MASH)” Test Level 3 criteria; or, crash tested in accordance with “National Cooperative Highway Research (NCHRP) Report 350 – Recommended Procedures for the Safety Performance Evaluation of Highway Features” Test Level 3 criteria.

Comments: For all attenuators, see the [CTDOT Highway Design Manual](#) for guidance.

Impact Attenuation Systems (Flared)				
ROADWAY SAFETY HARDWARE	Manufacturer	Testing Criteria	Test Level	Approval Basis
MFLEAT	Road Systems, Inc	MASH 2016	3	CC-143*
	Related Documents			
	Hardware Drawings			
	Installation Manual			
	Manufacturer's Online Installation & Inspection Course			
Slotted Rail Terminal (SRT-31)	Valtir (formerly Trinity Highway)	NCHRP 350	TL-3	CC-100*
	** FOR REPAIR ONLY UNLESS SPECIFIED **			
	Related Documents			
	Hardware Drawing(s)			
	<u>Installation Manual</u>			
Fleat-SP	Road Systems, Inc.	NCHRP 350	TL-3	CC-88*
	** FOR REPAIR ONLY UNLESS SPECIFIED **			
	UPGRADE TO MFLEAT DEVICE			
	Related Documents			
	<u>Hardware Drawing(s)</u>			
	<u>Installation Manual</u>			

Note: CC-####* is FHWA HARDWARE ELIGIBILITY LETTER
[Table last revised on 10/31/22]

Continued on Next Page:

Qualified Product Lists – Continued





Impact Attenuation Systems - Continued:

Impact Attenuation Systems (Median/Gore) *

SPECIFICATION: Standard Specification Section 18.03 IMPACT ATTENUATION SYSTEM

PREQUALIFICATION CRITERIA: Crash Tested in accordance with “AASHTO Manual for Assessing Safety Hardware (MASH)” Test Level 3 criteria; or, crash tested in accordance with “National Cooperative Highway Research (NCHRP) Report 350 – Recommended Procedures for the Safety Performance Evaluation of Highway Features” Test Level 3 criteria.

Comments: For all attenuators, see the CTDOT Highway Design Manual for guidance.

Impact Attenuation Systems (Median/Gore)				
ROADWAY SAFETY HARDWARE	Manufacturer	Testing Criteria	Test Level	Approval Basis
MAX-Tension Median	Lindsay Transportation Solutions	MASH 2016	TL-3	CC-141*
	Related Documents			
	Installation Manual			
Median Attenuating TREND Terminal (MATT)	Valtir (formerly Trinity Highway)	MASH 2016	TL-3	CC-175*
	Related Documents			
	Hardware Drawing			
	Installation Manual			
	CTDOT Engineering Installation Design Guide			
BEAT-MT	Road Systems, Inc.	NCHRP 350	TL-3	CC-69
	***** FOR HW-910 10 BOX BEAM *****			
	Related Documents			
	Hardware Drawing			
	Installation Manual			
C-A-T 350	Valtir (formerly Trinity Highway)	NCHRP 350	TL-3	CC-33*
	***** REPAIR ONLY SYSTEM *****			
	Related Documents			
	Hardware Drawing			
	Installation Manual			

Note: CC-###* is FHWA HARDWARE ELIGIBILITY LETTER
[Posted Nov 23 Table last revised on 10/3/23]

Qualified Product Lists – Continued

Impact Attenuation Systems - Continued:

Impact Attenuation Systems (Non-Gating)

SPECIFICATION(s): Owned Special Provision [0.135 Sec 1803 Impact Attenuation System 20220919](#)
Standard Specification Section 18.03 IMPACT ATTENUATION SYSTEM

PREQUALIFICATION CRITERIA: Crash Tested in accordance with “AASHTO Manual for Assessing Safety Hardware (MASH)” Test Level 3 criteria; or, crash tested in accordance with “National Cooperative Highway Research (NCHRP) Report 350 – Recommended Procedures for the Safety Performance Evaluation of Highway Features” Test Level 3 criteria.

Comments: For all attenuators, see the [CTDOT Highway Design Manual](#) for guidance.

Impact Attenuation Systems (Non-Gating)				
ROADWAY SAFETY HARDWARE	Manufacturer	Testing Criteria	Test Level	Approval Basis
NARROW IMPACT ATTENUATION SYSTEMS – SHIELDING LESS THAN 30” WIDE FIXED OBJECT				
SCI100GM	Hill & Smith Inc.	MASH 2016	TL-3	CC-128*
	Shields fixed object max. 24” wide			
	Unit size is 21’-6 1/8” Long by 37 7/16” wide			
	**** New Installations on Concrete Pad Only ****			
	Related Documents			
	Installation Manual Video(s) on SCI installation & Repair			
TAU-M	Lindsay Transportation Solutions	MASH 2016	TL-3	CC-147*
	Shields fixed object max. 27” wide			
	Unit size is 23-11" Long by 34.5” wide			
	**** New Installations on Concrete Pad Only ****			
	Related Documents			
	Installation Manual			
Delta Crash Cushion	Traffix Devices, Inc	MASH 2016	TL-3	CC-167*
	Shields fixed object max. 24” wide			
	Unit size is 21’ Long by 30” wide			
	**** New Installations on Concrete Pad Only ****			
	Related Documents			
	Hardware Drawings Installation Manual			
QUADGUARD M10	Valtir LLC	MASH 2016	TL-3	CC-112*
	Shields fixed object max. 24” wide			
	Unit size is 22’-4” Long by 31” wide			
	**** New Installations on Concrete Pad Only ****			
	Related Documents			
	Hardware Drawing(s) Installation Manual			

Note: CC-###* is FHWA HARDWARE ELIGIBILITY LETTER

[Posted Nov 23 Table last revised on 10/3/23]

**** For Concrete Pad size, refer to manufacturer’s drawings found in either Hardware Drawings or Installation Manual of Product

Continued on Next Page:

Qualified Product Lists – Continued

Impact Attenuation Systems (Non-Gating) - Continued:

Impact Attenuation Systems (Non-Gating)				
ROADWAY SAFETY HARDWARE	Manufacturer	Testing Criteria	Test Level	Approval Basis
WIDE IMPACT ATTENUATION SYSTEMS – SHIELDING 30” AND GREATER WIDE FIXED OBJECT				
Note; All Widening Occurs within the Impact Attenuator				
QUADGUARD	Valtir (formerly Trinity Highway)	NCHRP 350	TL-3	CC-35*
	Available System Shielding widths; 30,36,48,69,90,126 inches			
	** REPAIR ONLY SYSTEM FOR 24” SHIELDING **			
	Unit size ranges 19’-1” to 22’-1” Long by 31” to 135” wide			
	**** New Installations on Concrete Pad Only ****			
	Related Document Installation Manual Concrete Foundation Requirements			
QUADGUARD II	Valtir (formerly Trinity Highway)	NCHRP 350	TL-3	CC-35*
	Available System Shielding widths; 30,36,48,69,90,126 inches			
	** REPAIR ONLY SYSTEM FOR 24” SHIELDING **			
	Unit size ranges 19’-1” to 22’-1” Long by 31” to 135” wide			
	**** New Installations on Concrete Pad Only ****			
	Related Document			
TAU-II	Lindsay Transportation Solutions	NCHRP 350	TL-3	CC-75*
	Available System Shielding widths; 30,36,42,48,60,66, 72,78,84,90,96,102 inches			
	** REPAIR ONLY SYSTEM FOR 27” SHIELDING **			
	Unit size ranges 23’-10” Long by 37” to 112” wide			
	**** New Installations on Concrete Pad Only ****			
	Related Documents Installation Manual			

Note: CC-####* is FHWA HARDWARE ELIGIBILITY LETTER
******** For Concrete Pad size, refer to manufacturer’s drawings found
in either Hardware Drawings or Installation Manual of Product
[Posted Nov 23 Table last revised on 3/7/23]

Continued on Next Page:

Qualified Product Lists – Continued

Impact Attenuation Systems (Non-Gating) - Continued:

Impact Attenuation Systems (Non-Gating)				
ROADWAY SAFETY HARDWARE	Manufacturer	Testing Criteria	Test Level	Approval Basis
TRACC	Valtir (formerly Trinity Highway)	NCHRP 350	TL-3	CC-54*
	Available System Shielding width of 30 inches			
	** REPAIR ONLY SYSTEM FOR 24" SHIELDING **			
	Unit size is 22'-4" Long by 31" wide			
	**** New Installations on Concrete Pad Only ****			
	Related Documents			
	Installation Manual			
	Concrete Foundation Requirements			
WIDETRACC	Valtir (formerly Trinity Highway)	NCHRP 350	TL-3	CC-54*
	Available System Shielding widths of 41 or 58 inches			
	Unit size is 23-11" Long by 34.5" wide			
	**** New Installations on Concrete Pad Only ****			
	Related Documents			
	Installation Manual			
Concrete Foundation Requirements				
FASTRACC	Valtir (formerly Trinity Highway)	NCHRP 350	TL-3	CC-54*
 <ul style="list-style-type: none"> ● Plastic Nose Piece ● Base with Rip Plates ● Galvanized Steel Panel 	Available System Shielding width of 30 inches			
	Unit size is 21'-6 1/8" Long by 37 7/16" wide			
	**** New Installations on Concrete Pad Only ****			
	Related Documents			
	Installation Manual			
Concrete Foundation Requirements				

Note: CC-###* is FHWA HARDWARE ELIGIBILITY LETTER
 **** For Concrete Pad size, refer to manufacturer's drawings found
 in either Hardware Drawings or Installation Manual of Product
 [Posted Nov 23 Table last revised on 10/17/22]

Continued on Next Page:



Qualified Product Lists – Continued

Impact Attenuation Systems (Non-Gating - High Incident)

SPECIFICATION(s): Owned Special Provision [0.135 Sec 1803 Impact Attenuation System 20220919](#)
Standard Specification Section 18.03 IMPACT ATTENUATION SYSTEM

PREQUALIFICATION CRITERIA: Crash Tested in accordance with “AASHTO Manual for Assessing Safety Hardware (MASH)” Test Level 3 criteria; or, crash tested in accordance with “National Cooperative Highway Research (NCHRP) Report 350 – Recommended Procedures for the Safety Performance Evaluation of Highway Features” Test Level 3 criteria.

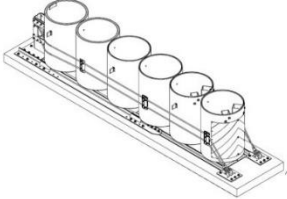
Comments: For all attenuators, see the [CTDOT Highway Design Manual](#) for guidance.

Impact Attenuation Systems (Non-Gating High Incident)				
ROADWAY SAFETY HARDWARE	Manufacturer	Testing Criteria	Test Level	Approval Basis
SCI100GM	Hill & Smith Inc.	MASH 2016	TL-3	CC-128*
	Shields fixed object max. 24” wide			
	Unit size is 21’-6 1/8” Long by 37 7/16” wide			
	**** New Installations on Concrete Pad Only ****			
	Related Document			
	Video on Installation			
	SCI Video on Repairs SCI Manual			
REACT 350	Valtir (formerly Trinity Highway)	NCHRP 350	TL-3	CC-26*
	Shields fixed object ranging from 8” to 36” wide			
	Unit size is 19’- 5” to 30’- 3” long by 41.5” wide			
	**** New Installations on Concrete Pad Only ****			
	Related Documents			
	Product Manual (6 Barrel System)			
	Product Manual (9 Barrel System) Concrete Foundation Requirement			
REACT 350 WIDE	Valtir (formerly Trinity Highway)	NCHRP 350	TL-3	CC-73*
	Available System Shielding widths of 60,96 and 120 inches			
	Unit size is 30’- 7” to 30’- 10” long by 71” to 122” wide			
	**** New Installations on Concrete Pad Only ****			
	Related Documents			
	Product Manual			
	Product Installation Manual			

Note: CC-###* is FHWA HARDWARE ELIGIBILITY LETTER
**** For Concrete Pad size, refer to manufacturer’s drawings found
in either Hardware Drawings or Installation Manual of Product
[Posted Nov 23 Table last revised on 10/17/22]

Qualified Product Lists – Continued

Pedestrian Barricade

SPECIFICATION: 1) Owned Special Provision 0979005A – Pedestrian Barricade
 2) Standard Specification, Section 9.79

PREQUALIFICATION CRITERIA:

- 1) Issuance of FHWA Reimbursement Eligibility Letter certifying that the device was crash tested in accordance with industry standards of 2016 AASHTO MASH for specified test level.
- 2) Compliance with the following Manual on Uniform Traffic Control Devices for Streets and Highways (MUTCD) 2009 Edition requirements:
 - Bottom and top surfaces shall be detectable by a person with a visual disability using a long cane;
 - The bottom of the bottom surface shall be at most 2 inches above the ground;
 - The top of the top surface shall be at least 32 inches above the ground;
 - Barricade color shall be orange, white, or yellow;
 - Devices can be interlocked. Connection points between adjacent barricades/barriers shall be smooth on the pedestrian side of the barricade;
 - Device supports shall not project more than 4 inches into the pedestrian path.

Test Level 3 - Roadways with posted speed limit of 60 mph or less	
Manufacturer/Supplier	Product Brand Name
Plastic Safety Systems 2444 Baldwin Road Cleveland, OH 44104 Website: pss-innovations.com Email: jesus.perez@pss-innovations.com Phone: (800) 662-.6338	SafetyWall SafetyRail
Valtir, LLC 3617 Cincinnati Avenue Rocklin, California 95765 Website: www.valtir.com Email: Paul.Kruse@valtir.com Phone: (916) 644-9102	YODOCK 2001 SiteGuide LCD
Plexco, LLC 3110 70 th Avenue East Tacoma, WA 98424 Website: www.pexco.com Email: Bob.Scott@pexco.com Phone: (253) 284-8000	TPAR (Temporary Pedestrian Access Route) Barricade

[Posted Nov 23 Table last revised on 11/1/23]

Pedestrian Barricade - Continued:

Qualified Product Lists – Continued

Pedestrian Barricade - Continued:

Test Level 2 - Roadways with posted speed limit of 40 mph or less	
Manufacturer/Supplier	Product Brand Name
Valtir, LLC 3617 Cincinnati Avenue Rocklin, California 95765 Website: www.valtir.com Email: Paul.Kruse@valtir.com Phone: (916) 644-9102	YODOCK 2001M

[Posted Nov 23 Table last revised on 11/1/23]

Qualified Product Lists – Continued

Penetrating Sealer Protective Compound

SPECIFICATION:

Owned Special provision 0819002A – Penetrating Sealer Protective Compound

PREQUALIFICATION CRITERIA:

Material Requirements:

- The penetrating sealer shall be a solution that penetrates to a depth of at least ½” into the concrete. The sealer shall react with free calcium within the concrete to form a permanent barrier that is integral with the concrete to protect against water and chloride intrusion.
- The sealer shall be clear and cause no significant change in appearance or texture of the concrete surface.
- The sealer shall not cause loss of traction on sidewalks or bridge decks.
- The VOC content shall be less than 100 grams/liter as calculated according to one of the following:
 - EPA Reference Method 24, 40 CFR 60, Appendix A, or an alternative test method approved by the New York Department of Environmental Conservation and the Administrator pursuant to NYSDEC Regulations Part 205.6(c) as indicated in the Connecticut Department of Energy and Environmental Protection (CT DEEP) Regulation 22a-174-41a.

Continued on Next Page:

Qualified Product Lists – Continued

Penetrating Sealer Protective Compound - Continued

Test Requirements:

Products shall be evaluated by AASHTO Product Evaluation & Audit Solutions (formerly NTPEP) for Concrete Coating and Sealers (CCS) and shall meet the following minimum pre-qualification criteria:

Test	Minimum Pre-Qualification Criteria
Moisture Vapor Transmission Drying Rate Coefficient (DRC)	≥ 80%
Waterproofing Performance/Saltwater Immersion Saltwater Absorption Ratio (SAR)	≥ 90%
Chloride Permeability	≥ 90% reduction
Total Chloride Ingress	≥ 85% reduction in chloride absorbed
Alkali Resistance	≥ 90% reduction
Depth of Penetration	6.35mm Minimum
Weathering/Saltwater Resistance	≥ 85% of non-weathered
Skid Resistance VS. Untreated	≥ 85% of non-weathered and/or
Weathered	≥ 90% BPN before treatment
Freeze Thaw	No visible cracking, spalling or powdering. FTR ≥ 90%
Saltwater Absorption post Freeze Thaw	≥ 85% of non-freeze thaw exposed

[Posted Nov 23 Table last revised on 2/8/23]

A Materials Certificate and Certified Test Report shall be submitted in accordance with Article 1.06.07 indicating that the product meets the requirements above. The date of testing shall be within 5 years of application for initial product approval.

PROVISIONS FOR CONTINUANCE ON QPL:

For current qualified products, testing shall be performed for any reformulation of the product(s).

Manufacturer/Supplier	Product Brand Name	Date of Test Compliance	Expiration Date
Wicktek Inc. 8097 Sacred Heart Lane Cincinnati, OH 45255 Website: www.wicktek.com	DensiCrete		December 31, 2023 ** See Note 1 **

**** Note 1:** Product remains “Qualified” while updated test data is under review.

[Posted Nov 23 Table last revised on 6/22/23]

Qualified Product Lists – Continued

Retroreflective Sheeting: Construction Barricade Sheeting

SPECIFICATION: 1) Standard Specification Section M.18.09

2) Material Certificate submission conforming to Standard Specification 1.06.07.

PREQUALIFICATION CRITERIA: 1) Conformance to ASTM D4956

2) Participation in the AASHTO Product Evaluation and Audit Solutions 1-Year Retroreflective Sheeting Test Deck.

Retroreflective Sheeting Type IV	
Manufacturer/Supplier	Product Brand Name
3M Company Transportation Safety Division 3M Center, Building 235-03W-052 St. Paul, MN 55144	3336 White/Orange
Avery Dennison Reflective Products Division 7542 Natchez Avenue Niles, IL 60714	W11144 White/Orange W11145 White/Orange

[Posted Nov 23 Table last revised on 3/20/20]

Retroreflective Sheeting Type XI	
Manufacturer/Supplier	Product Brand Name
3M Company Transportation Safety Division 3M Center, Building 235-03W-052 St. Paul, MN 55144	446 White/Orange

[Posted Nov 23 Table last revised on 3/20/20]

Qualified Product Lists – Continued

Retroreflective Sheeting: Traffic Drums, 42” Traffic Cones, Opposing Traffic Lane Divider, Glare Screens and Posts and Tubular Markers (Flexible) Sheeting

SPECIFICATION: 1) Standard Specification Section M.18.09
 2) Material Certificate submission conforming to Standard Specification 1.06.07.

PREQUALIFICATION CRITERIA: 1) Conformance to ASTM D4956
 2) Participation in the AASHTO Product Evaluation and Audit Solutions 1-Year Retroreflective Sheeting Test Deck.

Retroreflective Sheeting Type IV	
Manufacturer/Supplier	Product Brand Name
3M Company Transportation Safety Division 3M Center, Building 235-03W-052 St. Paul, MN 55144	3310 – White 3910 – White 3914 – Fluorescent Orange
Avery Dennison Corp. 7542 N. Natchez Avenue Niles, Illinois, 60714	WR-7100 Reboundable White Prismatic WR-7114 Reboundable Fluorescent Orange Prismatic

[Posted Nov 23 Table last revised on 2/15/23]

Retroreflective Sheeting: Traffic Cone Collar Sheeting

SPECIFICATION: 1) Standard Specification M.18.09
 2) Material Certificate submission conforming to Standard Specification 1.06.07.

PREQUALIFICATION CRITERIA: 1) Conformance to ASTM D4956

Retroreflective Sheeting Type VI	
Manufacturer/Supplier	Product Brand Name
3M Company Transportation Safety Division 3M Center, Building 235-03W-052 St. Paul, MN 55144	3340 – Flexible Prismatic Cone Sheeting

[Posted Nov 23 Table last revised on 2/15/23]

Qualified Product Lists – Continued

Retroreflective Sheeting: Construction Roll-Up Sign Sheeting

SPECIFICATION: 1) Standard Specification M.18.09

2) Material Certificate submission conforming to Standard Specification 1.06.07.

PREQUALIFICATION CRITERIA: 1) Conformance to ASTM D4956

2) Participation in the AASHTO Product Evaluation and Audit Solutions 1-Year Retroreflective Sheeting Test Deck.

Retroreflective Sheeting Type VI	
Manufacturer/Supplier	Product Brand Name
Avery Dennison Corp. 7542 N. Natchez Avenue Niles, Illinois, 60714	WU-7014 Fluorescent Orange
3M Company Transportation Safety Division 3M Center, Building 235-03W-052 St. Paul, MN 55144	RS60 - White RS64I – Fluorescent Orange RS20 - White RS24 – Fluorescent Orange RS33 – Fluorescent Pink
ORAFOL Americas, Inc. 120 Darling Drive Avon, CT 06001	ORALITE: Super Bright Roll-Up-Sign-Orange Marathon Roll Up Sign Fluorescent Orange

[Posted Nov 23 Table last revised on 2/15/23]

Qualified Product Lists – Continued

Retroreflective Sheeting: Delineator Non-Adhesive Backing Type Sheeting

SPECIFICATION: 1) Standard Specification M.18.09

2) Material Certificate submission conforming to Standard Specification 1.06.07.

PREQUALIFICATION CRITERIA: 1) Conformance to ASTM D4956

2) Participation in the AASHTO Product Evaluation and Audit Solutions 3-Year Retroreflective Sheeting Test Deck.

Retroreflective Sheeting Type V	
Manufacturer/Supplier	Product Brand Name
ORAFOL Americas, Inc. 120 Darling Drive Avon, CT 06001	ORALITE: AP1000 Red AP1000 White AP1000 Yellow AR1000 White AR1000 Yellow

[Posted Nov. 23 Table last revised on 3/20/20]

Qualified Product Lists – Continued

Retroreflective Sheeting: Sign and Delineator Sheeting

SPECIFICATION: 1) Standard Specification M.18.09

2) Material Certificate submission conforming to Standard Specification 1.06.07.

PREQUALIFICATION CRITERIA: 1) Conformance to ASTM D4956

2) Participation in the AASHTO Product Evaluation and Audit Solutions 3-Year Retroreflective Sheeting Test Deck.

Retroreflective Sheeting Type IV	
Manufacturer/Supplier	Product Brand Name
3M Company Transportation Safety Division 3M Center, Building 235-03W-052 St. Paul, MN 55144	3930 – White 3931 – Yellow 3932 – Red 3935 – Blue 3937 – Green 3939 – Brown
Avery Dennison Corp. 7542 N. Natchez Avenue Niles, Illinois, 60714	T-6500 – White T-6501 – Yellow T-6505 – Blue T-6507 – Green T-6508 – Red T-6509 – Brown
ORAFOL Americas, Inc. 120 Darling Drive Avon, CT 06001	5900-010 – White 5900-020 – Yellow 5900-030 – Red 5900-050 – Blue 5900-060 – Green 5900-080 – Brown

[Posted Nov. 23 Table last revised on 7/5/23]

Qualified Product Lists – Continued

Retroreflective Sheeting: Sign and Delineator Sheeting – Continued

Retroreflective Sheeting Type VIII	
Manufacturer/Supplier	Product Brand Name
3M Company Transportation Safety Division 3M Center, Building 235-03W-052 St. Paul, MN 55144	3924S Fluorescent Orange
Avery Dennison Corp. 7542 N. Natchez Avenue Niles, Illinois, 60714	W7514 Fluorescent Orange
ORAFOL Americas, Inc. 120 Darling Drive Avon, CT 06001	Oralite®: 5930-038 Fluorescent Orange

[Posted Nov. 23 Table last revised on 3/20/20]

Retroreflective Sheeting Type IX	
Manufacturer/Supplier	Product Brand Name
3M Company Transportation Safety Division 3M Center, Building 235-03W-052 St. Paul, MN 55144	3981 – Fluorescent Yellow 3983 – Fluorescent Yellow/Green 3990 – White 3991 – Yellow 3992 – Red 3995 – Blue 3997 – Green 4090 – white 4091 – Yellow 4092 – Red 4095 – Blue 4097 – Green 4081 – Fluorescent Yellow 4083 – Fluorescent Yellow-Green 4084 – Fluorescent Orange

Continued on Next Page:

Qualified Product Lists – Continued

Sign and Delineator Sheeting Type IX – Continued

Retroreflective Sheeting Type IX	
Manufacturer/Supplier	Product Brand Name
Avery Dennison Corp. 7542 N. Natchez Avenue Niles, Illinois, 60714	T-9500 – White T-9501 – Yellow T-9505 – Blue T-9507 – Green T-9508 – Red T-9513 – Fluorescent Yellow/Green W-9514 – Fluorescent Orange T-11500 – White T-11501 – Yellow T-11505 – Blue T-11507 – Green T-11508 – Red T-11511 – Fluorescent Yellow T-11513 – Fluorescent Yellow/Green W-11514 – Fluorescent Orange
ORAFOL Americas, Inc. 120 Darling Drive Avon, CT 06001	7900-010 – White 7900-020 – Yellow 7900-050 – Blue 7900-060 – Green 7900-029 – Fluorescent Yellow-Green 7900-037 – Fluorescent Yellow 5930-038 – Fluorescent Orange

[Posted Nov. 23 Table last revised on 9/14/22]

Continued on Next Page:

Qualified Product Lists – Continued

Retroreflective Sheeting: Sign and Delineator Sheeting – Continued

Retroreflective Sheeting Type XI	
Manufacturer/Supplier	Product Brand Name
3M Company Transportation Safety Division 3M Center, Building 235-03W-052 St. Paul, MN 55144	4090 – White 4091 – Yellow 4092 – Red 4095 – Blue 4097 – Green 4099 – Brown 4081 – Fluorescent Yellow 4083 – Fluorescent Yellow-Green
Avery Dennison Corp. 7542 N. Natchez Avenue Niles, Illinois, 60714	T-11500 – White T-11501 – Yellow T-11505 – Blue T-11507 – Green T-11508 – Red T-11509 – Brown T-11511 – Fluorescent Yellow T-11513 – Fluorescent Yellow-Green

[Posted Nov. 23 Table last revised on 1/7/21]

Qualified Product Lists – Continued

Spray-Applied Membrane Waterproofing System:

SPECIFICATION: Owned special provision Item No. 0707009A – Membrane Waterproofing (Cold Liquid Elastomeric)

PREQUALIFICATION CRITERIA:

A) Material requirements:

1. Primer: The primer shall be a 100% reactive, acrylic based, two components, spray applied resin capable of full cure in 40 minutes at 68°F (20°C).
2. Membrane: The membrane shall be 100% solvent free reactive, acrylic based, two components, spray applied material.
3. Aggregate: The aggregate shall be a nonfriable, durable #8 aggregate stone.

B) Test Requirements:

The membrane, when tested as an 80 mil (minimum thickness of 80 mil and a maximum thickness not to exceed 90 mil) sample alone or as a sample of the complete system comprised of the 80 mil as described above plus a 40 mil topping with aggregate, shall meet or exceed the following performance requirements:

Water Vapor Transmission	ASTM E96	0.3 Perms or less
Adhesion (Concrete)	ASTM D4541	150 psi (1.0 MPa) or failure in concrete.
Adhesion (Steel)	ASTM D4541	300 psi (2.1 MPa)
Minimum Tensile Strength	ASTM D638, Method A, Die C	940 psi (6.4 MPa)
Minimum Elongation at Break	ASTM D638, Method A, Die C	80%
Crack Bridging	ASTM 1305	Pass @ 10 cycles, 0.125 in. (3.2mm) -15°F (-26°C)
Resistance to Heat Aging	ASTM C1522	Pass

APPROVAL:

Submitted products will be reviewed for approval pending results of a one-year long test trial.

Continued on Next Page:

Qualified Product Lists – Continued

Spray-Applied Membrane Waterproofing System - Continued:

PROVISIONS FOR CONTINUANCE ON QPL:

All testing shall have been performed no longer than 5 years prior to the product installation date. Testing showing conformance with the above noted performance requirements shall be submitted to the Department who shall establish the “Date of Test Compliance”. Products with a “Date of Test Compliance” greater than 5 years prior to the product installation date shall not allowed to be used.

Manufacturer/Supplier	Product Brand Name	Date of Test Compliance	Expiration Date
Bridge Preservation, LLC 87 Shawnee Avenue Kansas City, KS 66105 Telephone: 913-321-9006 E-Mail TBD Website: TBD	Bridge Deck Membrane System	May 1, 2019	May 1, 2024
GCP Applied Technologies Inc. 100 Research Drive Wilmington, MA 01887 Telephone:617-498-4816	Eliminator	April 3, 2019	April 3, 2024
PIM Corporation 201 Circle Drive North, STE 105 Piscataway, NJ 08854 Telephone: 732-469-6224 E-Mail: pimcorp@pimcorp.com Website: www.pimcorp.com	PmB Blue Shield	October 20, 2022	October 20, 2027
Wasser Coatings Inc. 4118 B Place NW Suite B Auburn, WA 98001 Telephone: 216-536-6777 Email: kstull@wassercoatings.com Website: wassercoatings.com	Wasser Polyflex Bridge Deck System	November 7, 2018	April 1, 2024

[Posted Nov 23 Table last revised on 11/2/23]

Qualified Product Lists – Continued

Walls: Embankment Walls:

SPECIFICATION: Owned special provision:

1. ITEM #0601445A - #0601449A (SITE NO. 1 thru 5)
2. ITEM #0601490A - #0601495A (SITE NO. 6 thru 11)

PREQUALIFICATION CRITERIA: LRFD Bridge Design Specification

SUPPLIER/LOCATION	PRODUCT BRAND NAME
Connecticut Precast Corp. 555 Fan Hill Road Monroe, CT 06468 Telephone: 203-268-8688 Website: www.ctprecast.com	Recon Retaining Wall
Keystone Retaining Walls 4444 West 78 th Street Minneapolis, MN 55435 Telephone: 952-897-1040 Website: www.keystonewalls.com	KeySystem III Retaining Wall
Redi-Rock Walls - CT Division 68A South Canal Street Plainville, CT 06062 Telephone: 860-793-6805	Redi-Rock Retaining Wall-Cobblestone Face Mold
TENSAR Earth Technology, Inc. 227 Ritter Road Sewickley, PA 15143 Telephone: 412-749-9190	MESA Retaining Wall System
VERSA-LOK of New England 5 Northern Boulevard, Unit 15 Amherst, NH 03031 Telephone: 603-883-3042 E-Mail: Sales@wallsthatwork.com Website: www.versa-Lok.com	VERSA-LOK Retaining Wall

[Posted Nov. 23 Table last revised on 2/3/23]

Qualified Product Lists – Continued

Walls: Retaining Walls - Mechanically Stabilized Earth (MSE) Walls:

SPECIFICATION: Owned special provisions: Item #'s 0601651A, 0601665A, 0601678A & 0601687A RETAINING WALL

PREQUALIFICATION CRITERIA: LRFD Bridge Design Specification

SUPPLIER/LOCATION	PRODUCT BRAND NAME(S)
Contech Engineered Solutions LLC 9100 Centre Pointe Drive Westchester, OH 450069 Telephone: 774-402-0312	Vist-A-Wall Systems
Inventure Civil LLC P.O. Box 1781 Wake Forest, NC 27588 Telephone: (919) 453-2011	SINE WALL
Tricon Precast Limited 15055 Henry Road Houston, TX 77060 Telephone: 877-387-4266 Website: www.triconprecast.com	Tricon Retained Soil Wall System
The Reinforced Earth Company 45610 Woodland Road, Suite 200 Sterling, VA 20166 Telephone: 978-764-7315 E-Mail: PAnderson@reinforcedearth.com Website: www.reinforcedearth.com	Reinforced Earth Retained Earth

[Posted Nov. 23 Table last revised on 2/7/23]

Qualified Product Lists – Continued

Walls: Retaining Walls - Prefabricated Modular Walls:

SPECIFICATION: Owned special provisions: Item #'s 0601651A, 0601665A, 0601678A & 0601687A RETAINING WALL

PREQUALIFICATION CRITERIA: LRFD Bridge Design Specification

SUPPLIER/LOCATION	PRODUCT BRAND NAME
United Concrete Products Inc Retaining Wall Division 173 Church Street Yalesville T 06492 Telephone: 203-269-3119 E-Mail: dtopa@unitedconcrete.com Website: www.unitedconcrete.com	Doublewal Retaining Wall System
Earth Wall Products 1741 Dixie Ave SE Smyrna, GA 30080 Telephone: 678-594-3451 E-Mail: trainey@earthwallproducts.com Website: earthwallproducts.com	GRAVIX
The Reinforced Earth Company 45610 Woodland Road, Suite 200 Sterling, VA 20166 Telephone: 978-764-7315 E-Mail: PAnderson@reinforcedearth.com Website: www.reinforcedearth.com	T-Wall

[Posted Nov. 23 Table last revised on 2/15/23]

Qualified Product(s): Non - Proprietary Roadside Safety Hardware

Connecticut Department of Transportation
Non-Proprietary Roadside Safety Hardware

Qualified Product(s): Non - Proprietary Roadside Safety Hardware

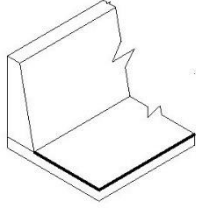
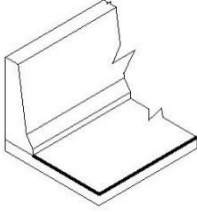
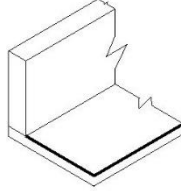
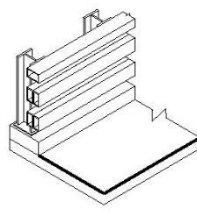
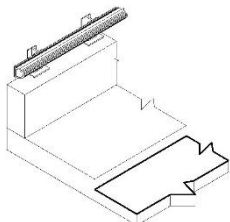
Parapets and Railing Designs for Bridges and Retaining Walls			
ROADSIDE SAFETY HARDWARE	Testing Criteria	Test Level	Approval Basis
42" SINGLE SLOPE CONCRETE PARAPET	MASH 2016	TL-4	Eng. Analysis
	Related Documents		
	42" SINGLE SLOPE CONCRETE PARAPET DRAWINGS		
42" F-SHAPE CONCRETE PARAPET	MASH 2016	TL-4	Eng. Analysis
	Related Documents		
	42" F-SHAPE CONCRETE PARAPET DRAWINGS		
42" VERTICAL CONCRETE PARAPET	MASH 2016	TL-4	Eng. Analysis
	Related Documents		
	42" VERTICAL CONCRETE PARAPET		
42" CURB MOUNTED BRIDGE RAILING	MASH 2016	TL-4	Eng. Analysis
	Related Documents		
	3-Tube Curb Mount Bridge Rail		
36" VERTICAL CONCRETE PARAPET WITH SIDEWALK	MASH 2016	TL-3	Eng. Analysis
	Related Documents		
	36" VERTICAL CONCRETE PARAPET WITH SIDEWALK		



[Table last revised on 8/24/21]

Qualified Product(s): Non - Proprietary Roadside Safety Hardware

Cable Barriers			
ROADSIDE SAFETY HARDWARE	Testing Criteria	Test Level	Approval Basis
THREE CABLE GUIDERAIL (I-BEAM POSTS)	NCHRP 350	TL-3	**
	Related Documents		
	Hardware Drawing Details HW-918_01a		

NOTE; ** Device approved prior to implementation of MASH – Compliant Determination Process



[Table last revised on 3/20/ 20]

Cable Barriers Terminal Ends			
ROADSIDE SAFETY HARDWARE	Testing Criteria	Test Level	Approval Basis
THREE CABLE END ANCHOR TYPE I	NCHRP 350	TL-3	**
	Related Documents		
	Hardware Drawing Details HW-918_01b & 01c		
THREE CABLE TRAILING END ATTACHMENT			**
	Related Documents		
	Hardware Drawing Details HW-918_01b		

NOTE; ** Device approved prior to implementation of MASH – Compliant Determination Process

[Table last revised on 3/20/ 20]

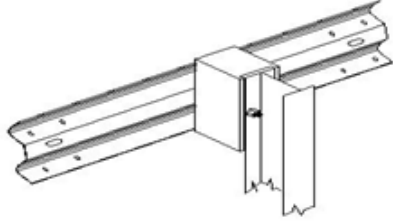
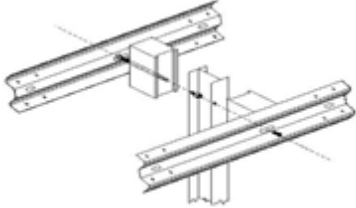
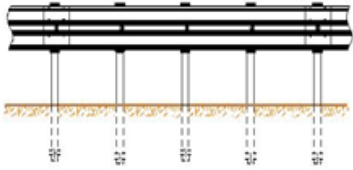
Qualified Product(s): Non - Proprietary Roadside Safety Hardware

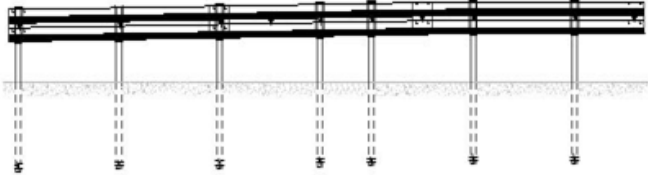
METAL BEAM RAIL (TYPE)			
ROADSIDE SAFETY HARDWARE	Testing Criteria	Test Level	Approval Basis
METAL BEAM RAIL (R-B MASH) GUIDERAIL	MASH 2016	TL-3	Eng. Analysis
	Related Documents		
	Hardware Drawing Details HW-910_21		
METAL BEAM RAIL (MD-MASH) GUIDERAIL	MASH 2016	TL-3	Eng. Analysis
	Related Documents		
	Hardware Drawing Details HW-910_22		
METAL BEAM RAIL (R-B MASH) HALF – POST SPACING	MASH 2016	TL-3	Eng. Analysis
	Related Documents		
	Hardware Drawing Details HW-910_23		
METAL BEAM RAIL (R-B MASH) QUARTER POST SPACING	MASH 2016	TL-3	Eng. Analysis
	Related Documents		
	Hardware Drawing HW-910_23		
METAL BEAM RAIL TRANSITION 350 TO MASH	NCHRP 350	TL-3	**
	Related Documents		
	Hardware Drawing HW-910_25		

Note: ** Device approved prior to implementation of MASH-Compliant Determination Process [Table last revised on 3/20/ 20]

Qualified Product(s): Non - Proprietary Roadside Safety Hardware



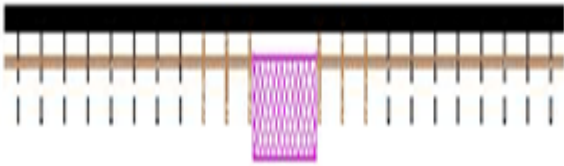
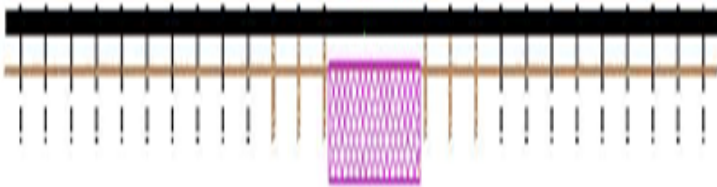

METAL BEAM RAIL (TYPE)			
ROADSIDE SAFETY HARDWARE	Testing Criteria	Test Level	Approval Basis
METAL BEAM RAIL 8" x 6" BOX BEAM	NCHRP 350	TL-3	**
	Related Documents		
	Hardware Drawing HW-910_10		

Note: ** Device approved prior to implementation of MASH-Compliant Determination Process [Table last revised on 3/20/ 20]

METAL BEAM RAIL SPAN SECTION (TYPE II OR III)			
ROADSIDE SAFETY HARDWARE	Testing Criteria	Test Level	Approval Basis
METAL BEAM RAIL SPAN SECTION TYPE II	MASH 2016	TL-3	**
	Related Documents		
	Hardware Drawing HW-910_24		
METAL BEAM RAIL SPAN SECTION TYPE III	MASH 2016	TL-3	**
	Related Documents		
	Hardware Drawing HW-910_24		

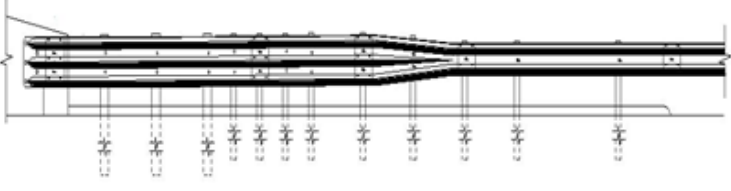
Note: ** Device approved prior to implementation of MASH-Compliant Determination Process [Table last revised on 3/20/ 20]

Qualified Product(s): Non - Proprietary Roadside Safety Hardware

(TYPE) ATTACHMENTS			
ROADSIDE SAFETY HARDWARE	Testing Criteria	Test Level	Approval Basis
THRIE-BEAM ATTACHMENT	MASH 2016	TL-3	Eng. Analysis
	Related Documents Hardware Drawing HW-910_27		
R-B 350 BRIDGE ATTACHMENT SAFETY SHAPE PARAPET	NCHRP 350	TL-3	**
	* FOR REPAIR ONLY UNLESS SPECIFIED ON CONTRACT DRAWING* Related Documents Hardware Drawing HW-910_06		
R-B 350 BRIDGE ATTACHMENT VERTICAL SHAPE PARAPET	NCHRP 350	TL-3	**
	* FOR REPAIR ONLY UNLESS SPECIFIED ON CONTRACT DRAWING* Related Documents Hardware Drawing HW-910_07		
MD-350 MEDIAN BARRIER SAFETY SHAPE ATTACHMENT TYPE I	NCHRP 350	TL-3	**
	Related Documents Hardware Drawing HW-910_15		
MD-350 MEDIAN BARRIER SAFETY SHAPE ATTACHMENT TYPE II	NCHRP 350	TL-3	**
	Related Documents Hardware Drawing HW-910_16		

Note: ** Device approved prior to implementation of MASH-Compliant Determination Process [Table last revised on 3/20/ 20]

Qualified Product(s): Non - Proprietary Roadside Safety Hardware

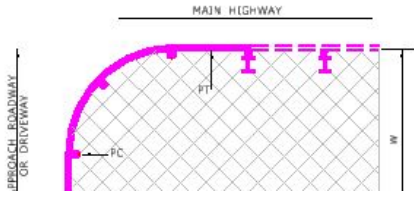
(TYPE) CURVED GUIDE RAIL TREATMENT			
ROADSIDE SAFETY HARDWARE	Testing Criteria	Test Level	Approval Basis
CURVED GUIDERAIL TREATMENT	NCHRP 230	TL-2	**
	Related Documents		
	Hardware Drawing HW-910_11		

Note: ** Device approved prior to implementation of MASH-Compliant Determination Process [Table last revised on 3/20/ 20]

R-B TERMINAL SECTION			
ROADSIDE SAFETY HARDWARE	Testing Criteria	Test Level	Approval Basis
R-B TERMINAL SECTION	NCHRP 350	TL-2	**
	Related Documents		
	Hardware Drawing HW-910_17		

Note: ** Device approved prior to implementation of MASH-Compliant Determination Process [Table last revised on 8/17/21]

(TYPE) END ANCHORAGE TYPE I			
ROADSIDE SAFETY HARDWARE	Testing Criteria	Test Level	Approval Basis
R-B END ANCHORAGE TYPE I			**
	* NOT CRASHWORTHY *		
	LOCATE OUTSIDE CLEAR ZONE		
	Related Documents		
	Hardware Drawing HW-911_01		

Note: ** Device approved prior to implementation of MASH-Compliant Determination Process [Table last revised on 3/20/ 20]

Qualified Product(s): Non - Proprietary Roadside Safety Hardware

(TYPE) END ANCHORAGE TYPE II			
ROADSIDE SAFETY HARDWARE	Testing Criteria	Test Level	Approval Basis
R-B END ANCHORAGE TYPE II			**
	* NOT CRASHWORTHY *		
	LOCATE OUTSIDE CLEAR ZONE		
	Related Documents		
	Hardware Drawing HW-911_01		

Note: ** Device approved prior to implementation of MASH-Compliant Determination Process [Table last revised on 3/20/ 20]

(TYPE) END ANCHORAGE			
ROADSIDE SAFETY HARDWARE	Testing Criteria	Test Level	Approval Basis
BOX BEAM END ASSEMBLY	NCHRP 350	TL-3	**
	Related Documents		
	Hardware Drawing HW-910_10		

Note: ** Device approved prior to implementation of MASH-Compliant Determination Process [Table last revised on 3/20/ 20]

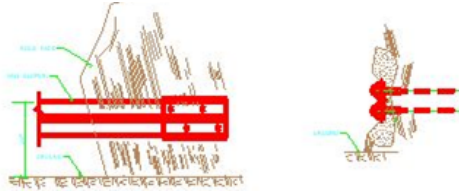
ANCHOR IN (TYPE) SLOPE			
ROADSIDE SAFETY HARDWARE	Testing Criteria	Test Level	Approval Basis
ANCHOR IN ROCK CUT SLOPE			**
	Related Documents		
	Hardware Drawing HW-911_03		

ANCHOR IN EARTH CUT SLOPE	NCHRP 350	TL-3	**
	Related Documents		
	Hardware Drawing HW-911_03		

Note: ** Device approved prior to implementation of MASH-Compliant Determination Process [Table last revised on 3/20/ 20]

Qualified Product(s): Non - Proprietary Roadside Safety Hardware

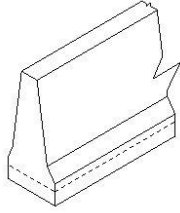
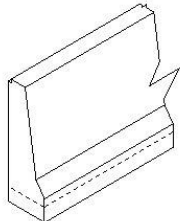
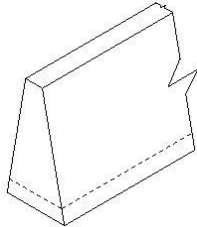
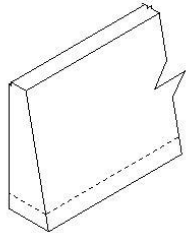
PRECAST CONCRETE BARRIER CURB			
ROADSIDE SAFETY HARDWARE	Testing Criteria	Test Level	Approval Basis
F-SHAPE PRECAST CONCRETE BARRIER CURB (30" x 45")			
	MASH 2016	TL-4	Eng. Analysis
	Related Documents		
	Hardware Drawing HW-821_02a & 02b		
F-SHAPE PRECAST CONCRETE BARRIER CURB (21" x 45")			
	MASH 2016	TL-4	Eng. Analysis
	Related Documents		
	Hardware Drawing HW-821_02a & 02b		
SINGLE SLOPE PRECAST CONCRETE BARRIER CURB (28" x 42")			
	MASH 2016	TL-4	Eng. Analysis
	Related Documents		
	Hardware Drawing HW-821_11a & 11b		
SINGLE SLOPE PRECAST CONCRETE BARRIER CURB (28" x 42")			
	MASH 2016	TL-4	Eng. Analysis
	Related Documents		
	Hardware Drawing HW-821_11a & 11b		

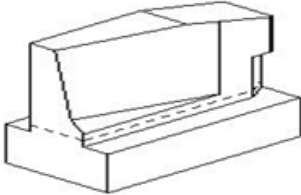
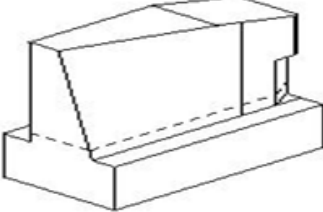
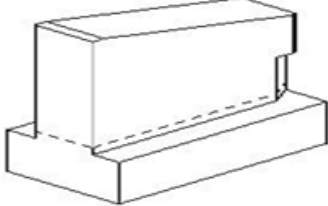

[Table last revised on 3/20/ 20]

Qualified Product(s): Non - Proprietary Roadside Safety Hardware

PRECAST CONCRETE BARRIER CURB			
ROADSIDE SAFETY HARDWARE	Testing Criteria	Test Level	Approval Basis
F-SHAPE PRECAST CONCRETE BARRIER CURB FOR THRIE-BEAM ATTACHMENT			
	MASH 2016	TL-4	Eng. Analysis
	Related Documents		
	Hardware Drawing HW-821_08a & 08b		
SINGLE SLOPE PRECAST CONCRETE BARRIER CURB FOR THRIE-BEAM ATTACHMENT			
	MASH 2016	TL-4	Eng. Analysis
	Related Documents		
	Hardware Drawing HW-821_09a & 09b		
VERTICAL PRECAST CONCRETE BARRIER CURB FOR THRIE-BEAM ATTACHMENT			
	MASH 2016	TL-4	Eng. Analysis
	Related Documents		
	Hardware Drawing HW-821_10a & 10b		

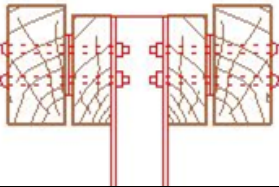

[Table last revised on 3/20/ 20]

Qualified Product(s): Non - Proprietary Roadside Safety Hardware



MERRITT PARKWAY RAIL TYPE			
ROADSIDE SAFETY HARDWARE	Testing Criteria	Test Level	Approval Basis
MERRITT PARKWAY GUIDERAIL	NCHRP 350	TL-3	**
	Related Documents		
	Hardware Drawing HW-910 12a&b		
MERRITT PARKWAY MEDIAN GUIDERAIL	NCHRP 350	TL-3	**
	Related Documents		
	Hardware Drawing HW-910 12d		
MERRITT PARKWAY GUIDERAIL SYSTEMS 2	NCHRP 350	TL-3	**
	Related Documents		
	Hardware Drawing HW-910 12a		
MERRITT PARKWAY GUIDERAIL SYSTEMS 3	NCHRP 350	TL-3	**
	Related Documents		
	Hardware Drawing HW-910 12a		

Note: ** Device approved prior to implementation of MASH-Compliant Determination Process [Table last revised on 3/20/ 20]

Qualified Product(s): Non - Proprietary Roadside Safety Hardware



MERRITT PARKWAY RAIL TYPE			
ROADSIDE SAFETY HARDWARE	Testing Criteria	Test Level	Approval Basis
MERRITT PARKWAY MEDIAN CONCRETE BARRIER	NCHRP 350	TL-3	Eng. Analysis
	Related Documents		
	Hardware Drawing HW-821_04b		
MERRITT PARKWAY NARROW CONCRETE BARRIER	NCHRP 350	TL-3	**
	Related Documents		
	Hardware Drawing HW-821_04a		

Note: ** Device approved prior to implementation of MASH-Compliant Determination Process [Table last revised on 3/20/ 20]

MERRITT PARKWAY (TYPE) ATTACHMENT			
ROADSIDE SAFETY HARDWARE	Testing Criteria	Test Level	Approval Basis
MERRITT PARKWAY GUIDERAIL LEADING END ATTACHMENT	NCHRP 350	TL-3	**
	Related Documents		
	Hardware Drawing HW-910_12a		
MERRITT PARKWAY GUIDERAIL TRAILING END ATTACHMENT			**
	Related Documents		
	Hardware Drawing HW-910_12c		

Note: ** Device approved prior to implementation of MASH-Compliant Determination Process [Table last revised on 3/20/ 20]

Qualified Product(s): Non - Proprietary Roadside Safety Hardware

MERRITT PARKWAY END ANCHORAGE (TYPE)			
ROADSIDE SAFETY HARDWARE	Testing Criteria	Test Level	Approval Basis
MERRITT PARKWAY GUIDERAIL END ANCHOR TYPE I			**
	* NOT CRASHWORTHY *		
	LOCATE OUTSIDE CLEAR ZONE		
	Related Documents		
	Hardware Drawing HW-911_05		
MERRITT PARKWAY GUIDERAIL END ANCHOR TYPE II			**
	* NOT CRASHWORTHY *		
	LOCATE OUTSIDE CLEAR ZONE		
	Related Documents		
	Hardware Drawing HW-911_05		
MERRITT PARKWAY GUIDERAIL END ANCHOR TYPE III	NCHRP 350	TL-3	Eng. Analysis
	Related Documents		
	Hardware Drawing HW-911_05		

Note: ** Device approved prior to implementation of MASH-Compliant Determination Process [Table last revised on 3/20/ 20]

MERRITT PARKWAY MEDIAN GUIDERAIL END ANCHORAGE			
ROADSIDE SAFETY HARDWARE	Testing Criteria	Test Level	Approval Basis
MERRITT PARKWAY MEDIAN GUIDERAIL END ANCHORAGE			**
	* NOT CRASHWORTHY *		
	LOCATE OUTSIDE CLEAR ZONE		
	Related Documents		
	Hardware Drawing HW-910_12d		



Note: ** Device approved prior to implementation of MASH-Compliant Determination Process [Table last revised on 3/20/ 20]

Qualified Product(s): Non - Proprietary Roadside Safety Hardware

SIGN SUPPORT			
ROADSIDE SAFETY HARDWARE	Testing Criteria	Test Level	Approval Basis
METAL SIGN POSTS	NCHRP 350	TL-3	**
	Related Documents Sign Post Hardware Drawing TR-1208_02		
BREAKAWAY SIGN SUPPORT	NCHRP 350	TL-3	**
	Related Documents Breakaway Sign Supports Hardware		
BREAKAWAY LUMINAIRE TRANSFORMER BASE	NCHRP 350	TL-3	**
	Related Documents Light Standard Hardware		
PEDESTAL BASE	NCHRP 350	TL-3	**
	Related Documents Pedestal Base TR-1102_01 Traffic Control Foundation Pedestal - Type I - Precast TR-1002_01		

Note: ** Device approved prior to implementation of MASH-Compliant Determination Process [Table last revised on 3/20/ 20]

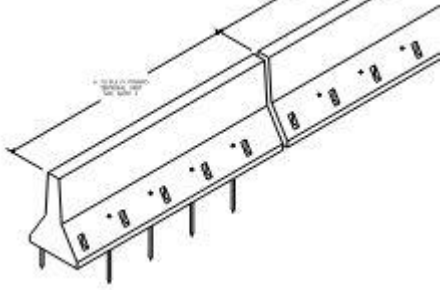
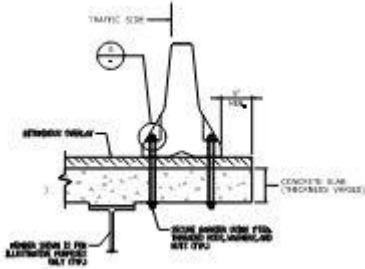
Qualified Product(s): Non - Proprietary Roadside Safety Hardware

TEMPORARY WORKZONE DEVICES			
ROADSIDE SAFETY HARDWARE	Testing Criteria	Test Level	Approval Basis
Temporary Traffic Barrier	MASH 2016	TL-3	Eng. Analysis
Temporary Traffic Barrier (Pinned)	MASH 2016	TL-3	Eng. Analysis
	Related Documents		
	Hardware Drawing No. HW-822_02c		
Temporary Traffic Barrier (Bolted)	MASH 2016	TL-3	Eng. Analysis
	Related Documents		
	Hardware Drawing No. HW-822_02b		
Temporary Precast Concrete Barrier Curb	NCHRP 350	TL-3	***
	Related Documents		
	Hardware Drawing HW-822_01		

[Table last revised on 8/6/21]

Note: *** Any Temporary Work zone device manufactured on or before December 31,2019 and successfully tested to NCHRP Report 350 or the 2009 Edition of MASH, may be used throughout their normal service life.

Bureau of Highway Operations Qualified Products

Connecticut Department of Transportation
Bureau of Highway Operations
Qualified Products List

Bureau of Highway Operations Qualified Products

Pre-packaged, Concrete Repair Material -- for Use by Office of Maintenance only

SPECIFICATION: All material types shall be furnished in pre-packaged containers or bags with all the ingredients necessary for the proper mixing of the material included, except for water or admixtures. See below for material requirements.

ACCEPTANCE: Submitted products will be reviewed for acceptance pending the results of a one-year long test trial installation. The test trial shall be at a site in CT designated by the Department with material furnished by the manufacturer and attended by a Manufacturer’s Technical representative to advise on recommended installation procedures and address installation questions.

PROVISIONS FOR CONTINUANCE ON QPL: Product will be continually monitored for satisfactory performance; unsatisfactory performance will result in product’s removal from qualified list. Additionally, re-formulation of product will negate previous incorporation on the list and the product will need to be re-evaluated (including new test trial installation) with positive results prior to re-instatement on Qualified Product List.

MATERIAL CATEGORIES:

- 1) TYPE 1 MATERIAL for CONCRETE DECK REPAIRS shall be a fast-setting repair material intended for repairs of concrete bridge decks.

PRE-APPROVAL CRITERIA:

The material shall meet or exceed the following performance requirements:

Compressive Strength	ASTM C39	3-hour – 3,000psi 7-day – 5,000psi 28-day – 6,000psi
Aggregate Soundness	ASTM C88 using Mag.Sulfate	max.10% loss after 5 cycles
Aggregate Abrasion Loss	ASTM C131	max. 40% loss

- 2) TYPE 2 MATERIAL for STRUCTURAL CONCRETE REPAIRS shall be a material intended for the repair of structural concrete elements.

PRE-APPROVAL CRITERIA:

The material shall meet or exceed the following performance requirements:

Compressive Strength	ASTM C39	7-day – 5,000psi 28-day – 6,000psi
Aggregate Soundness	ASTM C88 using Mag.Sulfate	max.10% loss after 5 cycles
Aggregate Abrasion Loss	ASTM C131	max. 40% loss

Continued on Next Page:

Bureau of Highway Operations Qualified Products

Prepackaged Concrete Repair Material - Continued:

- 3) TYPE 3 MATERIAL for COLD-WEATHER CONCRETE REPAIRS shall be a material intended for the repair of concrete elements in temperatures down to 10 deg Fahrenheit.

PRE-APPROVAL CRITERIA:

The material shall meet or exceed the following performance requirements:

Compressive Strength	ASTM C39	7-day – 5,000psi 28-day – 6,000psi
Aggregate Soundness	ASTM C88 using Mag.Sulfate	max.10% loss after 5 cycles
Aggregate Abrasion Loss	ASTM C131	max. 40% loss

Manufacturer/Supplier	Product Brand Name	Type Category Allowed Use
Kwik Bond Polymers 923 Teal Drive Benicia, CA 94510 Telephone: 724-718-5678 E-Mail: tzur@kwikbondpolymers.com Website: www.kwikbondpolymers.com	PPC-1121	Type 1 & Type 3
Quikrete Companies, LLC Five Concourse Parkway Atlanta, GA 30328 www.quickrete.com	Rapid Road Repair – CA Extended	Type 1
Quikrete Companies, LLC Five Concourse Parkway Atlanta, GA 30328 www.quickrete.com	Form and Pour Concrete Mix MS	Type 3
Sakrete of North America 625 Griffith Road Charlotte, NC 28217 www.sakrete.com	Pro Mix Accelerated Concrete Mix	Type 1 & Type 2
US Mix Company 112 South Santa Fe Drive Denver, CO 80223 www.usmix.com	Transpatch Concrete SC Concrete	Type 1 Type 1

[Posted Nov. 23 Table Last Revised 2/14/23]

Qualified Product(s): Non - Proprietary Roadside Safety Hardware

Bituminous Concrete Patching Materials (Cold Applied):

SPECIFICATION: REFERENCE FILE No. 2011-01

PREQUALIFICATION CRITERIA: Compliance with Section 22a-174-20(k) of the Regulations of Connecticut State Agencies (DEEP). Material must be supplied as a bulk mixture capable of being stockpiled outdoors unprotected and workable for a period no less than 6 months after delivery.

Manufacturer/Supplier	Product Brand Name
B. Metcalf Asphalt Mr. Benjamin Metcalf 235 East Canaan Rd East Canaan, CT 06024 Website: www.bmetcalfasphalt.com	GemPatch
Cold Mix Manufacturing Corp. Mr. Dario Amicucci 65 Edison Avenue Mount Vernon, NY 10550 Office Telephone: 800-985-9192 Website: www.GREENPATCH.com	GreenPatch
The EZ Street Company Mr. Tom Francione 1786 NW 82 Avenue Miami, FL 33126 Website: www.ezstreetasphalt.com	EZ Street Cold Asphalt

[Posted Nov. 23 Table Last Revised 6/22/23]

Continued on Next Page:

Qualified Product(s): Non - Proprietary Roadside Safety Hardware

Bituminous Concrete Patching Materials (Cold Applied) - Continued:

Manufacturer/Supplier	Product Brand Name
Aquaphalt - RoadStone Production 1230 River Rd. Charlottesville, VA. 22901 Website: www.aquaphalt.com	Aquaphalt
CONTACT-NO Tri-Products, LLC Mr. Mike Jennings - still on website 89 Ship Street Providence, RI 02903 Website: www.hudsoncompanies.com	Plus Patch Asphalt Emulsion
Logan County Asphalt Mr. Steven McBride 2905 Commerce Boulevard Guthrie, OK 73044 Website: www.prolinecoldasphalt.com	ProLine Cold Asphalt Patching Material
Quality Pavement Repair Mr. Anthony J. Fagnoli 154 Bouckhart Avenue Rochester, NY 14622 Website: www.qprcoldpatch.com	QPR
UNIQUE Paving Materials Corp Mr. Brandon Holm 3993 East 93 rd Street Cleveland, OH 44105 Telephone: 603-361-7386 Email: BHolm@uniquepavingmaterials.com Website: www.uniquepavingmaterials.com	UPM Permanent Pavement Repair Material

[Posted Nov. 23 Table Last Revised 2/7/23]